

CNT-66

Programmable Timer/Counter

Users Manual

4031 600 66001
Rev. 01 (September 2000)

This manual, in whole or in part, may not be copied without permission.
All product name are trademarks of their respective companies.

© 2000 Pendulum Instruments AB
All rights reserved. Printed in Sweden.

Table of Contents

EC DECLARATION OF CONFORMITY	IV	Summary of Bus Commands	5-13
1 Safety Instructions		Programming Examples	5-14
Safety	1-2	6 Performance Check	
Introduction	1-2	Performance Check.	6-2
2 Product Presentation		7 Calibration and Adjustment	
General	2-2	Calibration	7-2
Rear View	2-2	Timebase References	7-3
Front View	2-3	8 Specifications	
3 Installation		Measuring Functions	8-2
Unpacking	3-2	Input-A and Input-B	8-3
Voltage Range Selection.	3-2	Input C	8-3
Grounding	3-3	External Reference Input D	8-3
Connecting External Reference	3-3	Auxiliary Functions	8-4
Installing the Rack Mount Adapter	3-3	Definitions	8-4
4 Operating Instructions		General Specifications	8-5
Using the Timer/Counter	4-2	Environmental Data	8-6
Error Codes	4-14	Mechanical Data	8-6
5 GPIB-interface Operation		Optional Accessories	8-6
Introduction	5-2	Ordering Information	8-7
What can I do using the Bus?	5-2	9 Appendix	
Connecting the Controller	5-3	Checking the Sensitivity of Counters.	9-2
Giving the Counter an Address	5-3	10 Service	
Checking the Communication	5-3	Sales and Service office.	II
Two Ways of Programming.	5-4	GUARANTEE STATEMENT.	III
Syntax	5-4	11 Index	
Selecting Output Separator	5-5	Index	II
How to Select Function	5-5		
Selecting Measuring-Time.	5-6		
Selecting Input settings	5-6		
Totalize Start/Stop.	5-7		
Free-Run/Triggered.	5-7		
Service Request	5-8		
Status Byte	5-8		
Output Mode	5-10		
Bus Learn	5-12		
Programming Data Out	5-12		
What Happens When I Switch to Local?	5-12		

EC DECLARATION OF CONFORMITY

Number: 4031 100 63700A41

The undersigned, representing the following manufacturer:

Manufacturer:

Pendulum Instruments AB
Sorterargatan 26, Box 541
SE-162 15 Vällingby, Sweden

Representative: Jan Herwe

Function: Quality Manager

herewith declare that the product:

Product Identification:

Product:	Timer/Counter
Brand:	Pendulum
Model:	CNT-66
Version:	All models

is in conformance with the EC Directive 89/336/EEC based on test results using harmonized standards in accordance with Article 10(1) of the directive and the directive LVD-73/23/EEC.

Test report no:

Title

Safety release certificate March 18, 1996
SEMKO EMC test report 953210I.3
CEM-Consult AB: CC-EMC/88-1044

Harmonized standards used:

Safety:	EN 61010-1 (1990) + A1 (1992) + A2 (1995) CAT II
EMC:	EN 55011 (1991) Group 1, Class B EN 50082-1 (1992)

Place: Vällingby Date: 2000-05-29

This Conformity is indicated by the symbol  i.e. "Conformité européenne".

Chapter 1

Safety Instructions

Safety

Introduction

Read this page carefully before you install and use the CNT-66 Timer/Counter.

This Timer/Counter has been designed and tested in accordance with EN 61010-1 and has been supplied in a safe condition. The user of this instrument must have the required knowledge of CNT-66. This knowledge can be gained by thoroughly studying this manual.

Safety Precautions

Use generally-accepted safety procedures, in addition to the safety precautions stated in this manual, to ensure personal safety and safe operation of the Timer/Counter.

Caution and Warning Statements

You will find specific warning and caution statements, where necessary throughout the manual. Do not carry out repairs or adjustments to the Timer/Counter without reading the Service Manual, which contains the relevant warnings for such activities.

CAUTION: Indicates where incorrect operating procedures can cause damage to, or destruction of, equipment or other property.

WARNING: Indicates a potential danger that requires correct procedures or practices in order to prevent personal injury.

Symbols



Indicates where the protective ground lead is connected inside the instrument. Never unscrew or loosen this screw.



Signal Ground symbol. This symbol indicates that the signal ground of the connectors are internally connected to the other connectors with the same symbol, and to parts that are easily accessible for the user.



Indicates that the operator should consult the manual.

Such symbols are printed near the input connectors. This symbol on the instrument should encourage the user to use the correct procedure for common instrument ground, and maximum input voltages, as described in the Installation and Specification chapters.

If in Doubt About Safety

Whenever you suspect that it is unsafe to use the instrument, you must make it inoperative, clearly mark it to prevent its further operation, and inform the Pendulum servicing department.

E.g. The instrument is likely to be unsafe if it is visibly damaged.

Chapter 2

Product Presentation

General

The CNT-66 is a compact, high resolution, reciprocal Timer/Counter which performs many functions. A number of options are available i.e. HF-input, GPIB-interface and high stability oscillator.

A rack-mount kit and a carrying case are also available as accessories.

Rear View

- S) Rear feet.
- T) Screws for removing the cover.
- U) External-reference-input, BNC connector.
- V) Voltage-range selector.
- W) Power-inlet socket.
- X) GPIB interface-connector (optional).
- Y) GPIB address-selector (option).

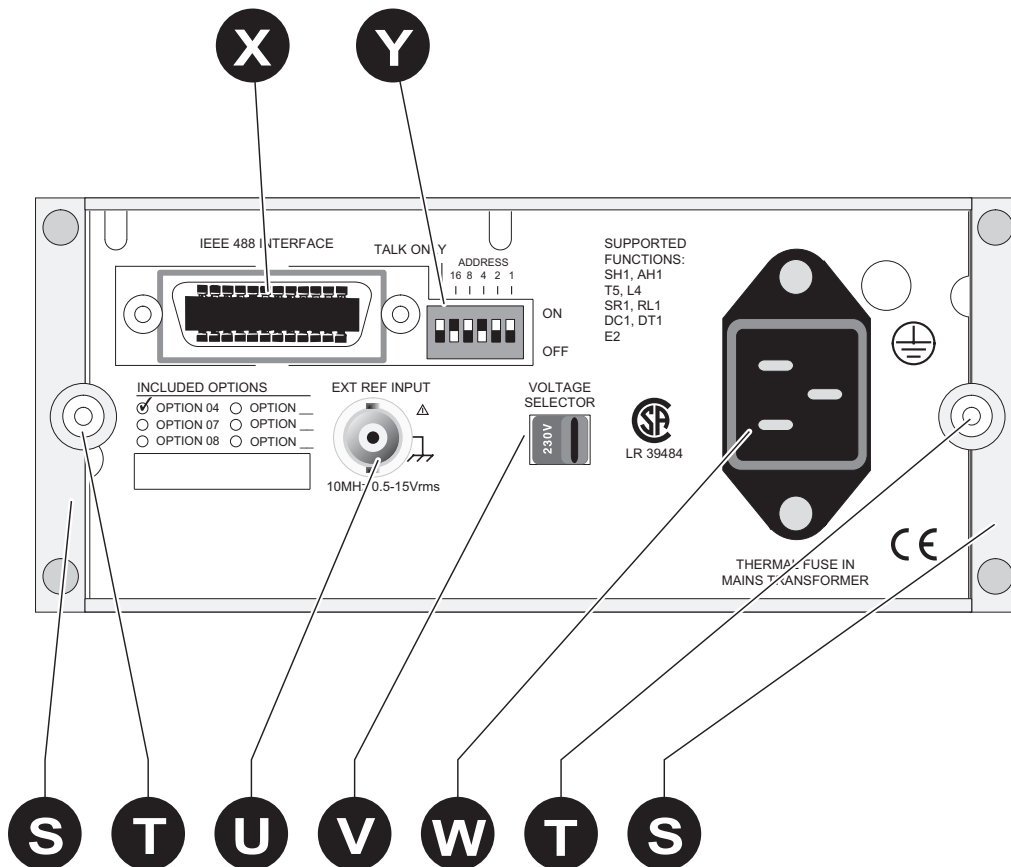

Figure 2-1 Rear View

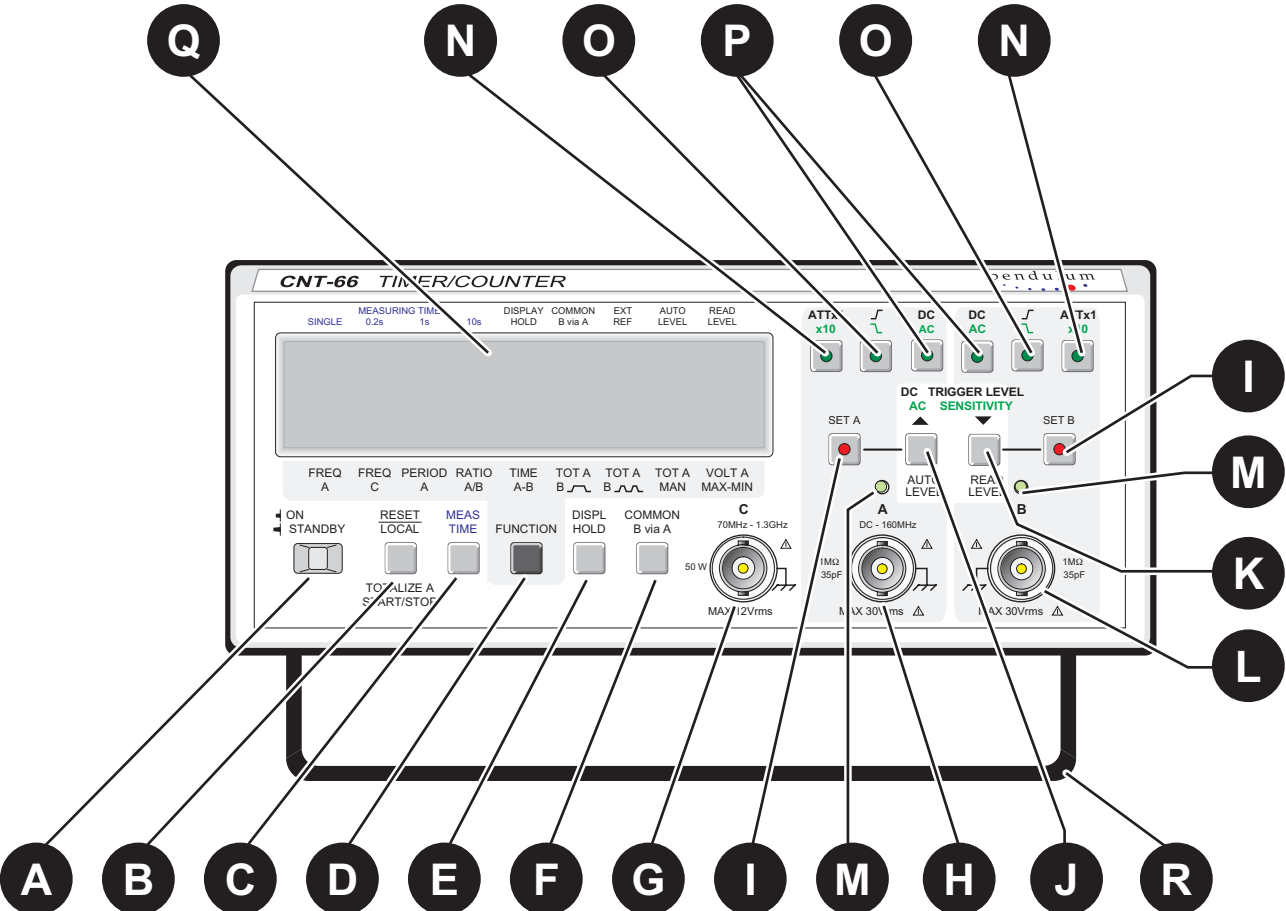

Figure 2-2 Front View

Front View

- A) Power switch.
- B) Reset button, doubles as Local button if the Timer/Counter is equipped with an GPIB interface. Starts and stops counting if the TOT A MAN function is selected.
- C) Measuring-time selector-button. *
- D) Function-selector button. *
- E) Display-hold button. Freezes the display.
- F) COM B via A button connects the signal on input A to input B. The Input-A attenuator and AC/DC switch affect both inputs.
- G) Input-C BNC-connector (optional).
- H) Input-A BNC-connector.
- I) Set value button, depress to set sensitivity (AC) or trigger level (DC).

- J) Auto level, starts automatic trigger level setting. If 'Set Value' is selected, this button is used to increase the value.
- K) Read level, displays trigger levels. If 'Set Value' is depressed, this button is used to decrease the value.
- L) Input-B BNC-connector.
- M) Trigger indicators.
- N) Attenuator buttons.
- O) Slope selection buttons.
- P) DC or AC coupling selection buttons.
- Q) Large LCD-display.
- R) Tilting support.

* The selected function is indicated on the display. A short press on the button moves the cursor one step to the right. A long press makes the cursor scroll.

This page is intentionally left blank.

Chapter 3

Installation

Unpacking

If the Timer/Counter is cold, leave it in the cardboard box until it has reached normal room temperature.

- Lift the Timer/Counter out of the box.
- Remove the polystyrene supports.
- Unpack the Timer/Counter from the plastic bag.
- Reverse the procedure to pack.

Check List

Has the Timer/Counter been damaged in transport? If it has, file a claim with the carrier immediately, and notify the Pendulum sales & service organization to make repair or replacement of the instrument easier.

- Check that the package contains the following items in addition to the Timer/Counter:
- This Operators' Manual
- A power cable with protective earth conductor
- An MTCXO oscillator if ordered option 07 *
- A GPIB interface if ordered option 04 *
- * Check marks on the rear panel indicate which options are fitted in your Timer/Counter.

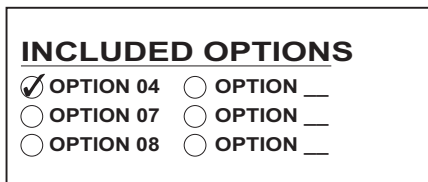

Figure 3-1 Options Label on Rear Panel.

Voltage Range Selection

Set the Timer/Counter to the local line voltage before connecting it. As delivered the Timer/Counter may be set to either 115 V or 230 V. The setting is indicated on the voltage range selector on the rear panel.

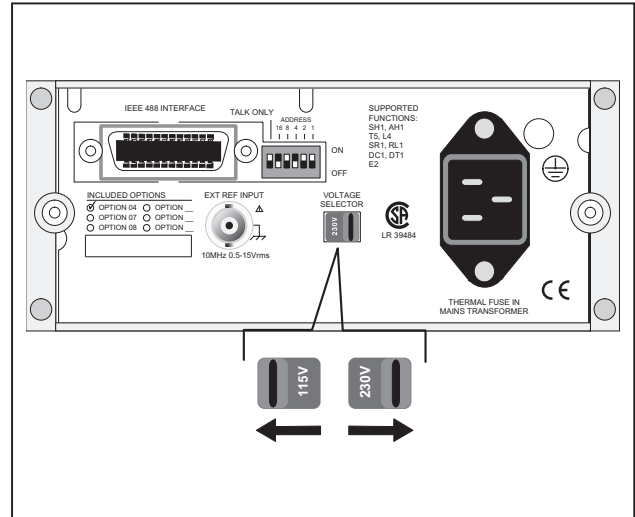

Figure 3-2 Location of Voltage Range Selector.

If the voltage range setting is incorrect, set the selector in accordance with the local voltage before connecting the power cable to the line.

Grounding

The Timer/Counter is connected to ground via a sealed three-core power cable, which must be plugged into a socket outlet with a protective ground terminal. No other grounding is permitted for this Timer/Counter. Extension cables must always have a protective ground conductor.

WARNING: Never interrupt the protective grounding intentionally. Any interruption of the protective ground connection inside or outside the instrument, or disconnection of the protective ground terminal is likely to make the instrument dangerous.

Connecting External Reference

If you wish to use an external 10 MHz reference frequency source, connect it via a BNC-cable to the EXT REF INPUT on the rear panel of the Timer/Counter.

When the Timer/Counter starts measuring, it automatically detects the external reference and begins to use it. The EXT REF indicator on the display is switched on.

Installing the Rack Mount Adapter

The option 06 is a 19" wide and 2E (88 mm) high Rack Mounting Adapter. It can host one CNT-66 or CNT-69 Counter.

Check list

Check that this box contains the following items:

- One rack shelf.
- One front plate.
- One plastic bag containing:
 - One large and one small bracket.
- One locking bar.
- Three countersunk screws M3x8.
- Two screws M3x8.
- Two spring-washers for the above screws.
- Two self adhesive rubber feet.

Besides the parts in the kit you will also need:

- Four square nuts for your rack.
- Four screws for the above nuts.

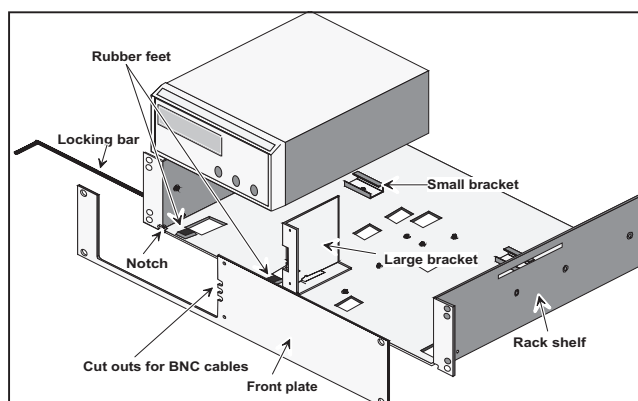

Figure 3-3 Option 06

Tools and equipment

To be able to install the Rack Mount Kit in a safe way, you need:

- One Torx 10 screwdriver

Fitting Counter on the Rack Shelf

■ CNT-66 and CNT-69

- Fit the small bracket with one countersunk screw through the hole closest to the rear of the shelf.

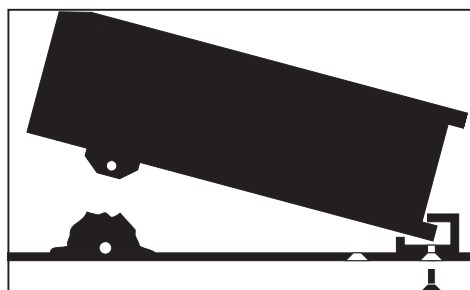

Figure 3-4 Fit the small bracket with the countersunk

- Fit the rubber feet according to Figure 3-4.
- Fit the large bracket with two countersunk screws.
- Turn the Counter upside down and remove the tilting support.
- Engage the lower rear part of the counter-cover with the small bracket and lower the front of the counter until it rests on the rubber feet.
- Fasten the counter by pressing the locking bar through the holes in the front feet of the counter.

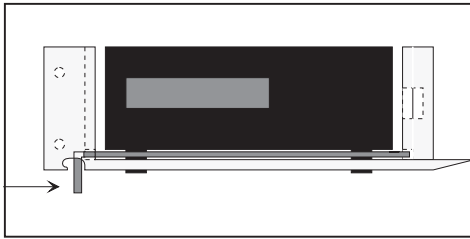

Figure 3-5 *Fasten the counter with the locking bar.*

- Turn the bar until it locks in the notch in the shelf.
- If your measuring cables are inside the rack, then push the BNC cables through the hole in the bracket before fitting the front plate.
- Fasten the front plate with the two M3x8 screws and locking-washers.

Now fit the option 06 in your rack and connect the cables.

Chapter 4

Operating Instructions

Using the Timer/Counter

CONTROL

ON
STANDBY



OPERATING THE CONTROL

POWER, a two-position mechanical push-button. Depressed = ON, Released = OFF

DISPLAY

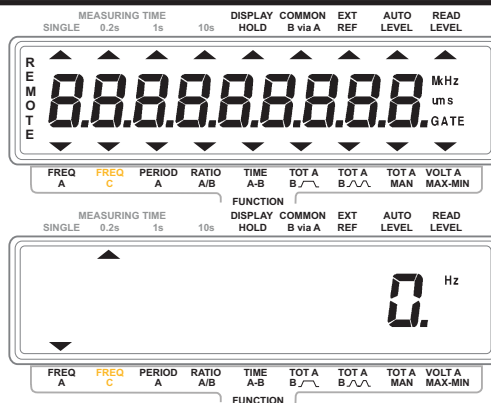

GPIB-CODE

No control possible but **D** gives the same settings as after power-ON.

FUNCTION



A short depression of the **FUNCTION** button moves the cursor in the lower edge of the display one step to the right. If the button is held depressed, the cursor will scroll to the right until released. When the cursor reaches the rightmost position it jumps back to the leftmost position and continues from there.

One code for each function, - see below:

FUNCTION



Move function cursor to **FREQ A**

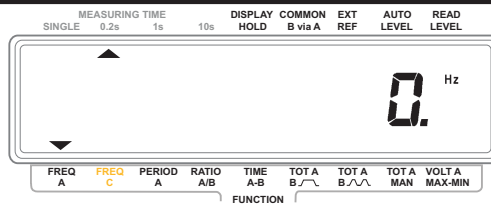

FREQ A
(FREQ B possible via Bus)

FUNCTION AND RANGE

HINTS AND COMMENTS

Switches the power ON and OFF. When switched on, the built in microprocessor switches on all segments of the display then it runs a power-up test, checking the measuring-logic of the Timer/Counter before the counter starts working. This test takes about 2 seconds.

WARNING: The power switch operates on the secondary side of the transformer. The power cable must be disconnected from the line outlet socket if it is necessary to completely isolate the Timer/Counter from the line.

If an error is found, an error code will be displayed. Try switching the Timer/Counter off and on again. If error code 01 - 03 persists, call Pendulum service. Look on the last page in this manual for Phone No. and address.

Error 01 = RAM memory error
 Error 02 = Measuring logic error
 Error 03 = Internal bus error
 Error OF = Overflow in the counting registers.

Selects one of the nine measuring functions available.

Reciprocal frequency measurement of the signal at Input-A.

If the signal is sine shaped and the input AC coupled, the minimum input frequency is 20 Hz (at specified sensitivity).











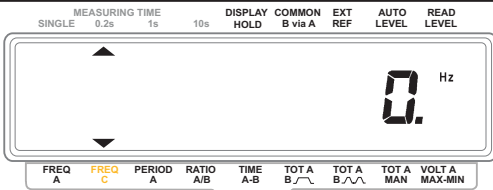

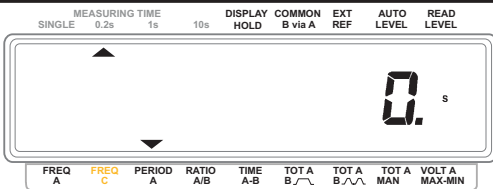
Range:
 0.1 Hz to 16 MHz (SINGLE measuring-time)
 1 Hz to 160 MHz (0.2, 1, and 10 s measuring-time)

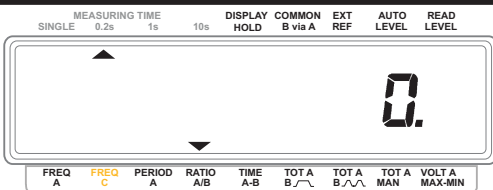
CONTROL

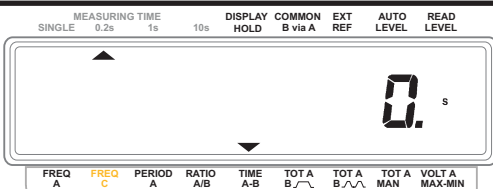
OPERATING THE CONTROL

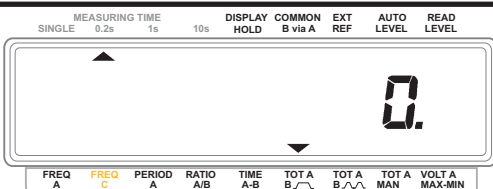
DISPLAY

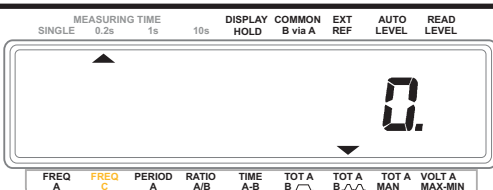
GPIB-CODE

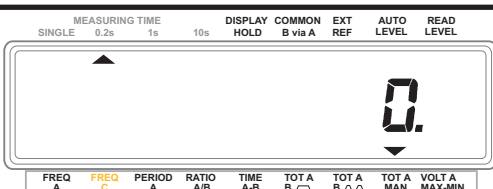
<p>FUNCTION</p> 	<p>Move function cursor to FREQ C</p>		<p>FREQ C</p>
<p>FUNCTION</p> 	<p>Move function cursor to PER A</p>		<p>PER A</p>
<p>FUNCTION</p> 	<p>Move function cursor to RATIO A/B</p>		<p>RATIO A,B (RATIO B,A RATIO C/A and RATIO C/B also possible via bus)</p>
<p>FUNCTION</p> 	<p>Move function cursor to TIME A-B</p>		<p>TIME A,B (TIME B,A also possible via bus)</p>
<p>FUNCTION</p> 	<p>Move function cursor to TOT A B</p>		<p>TOT A,B (TOTG B,A also possible via bus)</p>
<p>FUNCTION</p> 	<p>Move function cursor to TOT A B</p>		<p>TOTS A,B (TOTS B,A also possible via bus)</p>
<p>FUNCTION</p> 	<p>Move function cursor to TOT A MAN</p>		<p>TOTM A (TOTM B also possible via Bus)</p>

FUNCTION AND RANGE

HINTS AND COMMENTS

Reciprocal frequency measurement of the signal at Input-C.

Range:
70 to 1300 MHz

When you select SINGLE, the Timer/Counter measures one period, the range is: 100 ns to 200 000 000 s (about 6 years and four months!).

When you select 0.2, 1, and 10 s Measuring-time, the Timer/Counter divides the input frequency by 10 and measures the average period for the No. of cycles in that time.

Range:
8 ns to 1 s.

Use SINGLE when the input frequency is low. This shortens the measuring time considerably since one cycle is measured instead of 10.

The number of pulses at Input-A and the number of pulses at Input-B are fed into one register each. When the set Measuring-time has elapsed, register A is divided by register B.

Range:
 $1 \cdot 10^{-7}$ to $1.2 \cdot 10^9$

The signal with the lowest frequency must always be connected to Input-B.

The Timer/Counter measures the time between a positive slope on Input-A and a positive slope on Input-B (default).

Range:
100 ns to $2 \cdot 10^8$ s (SINGLE)
0 ns to 20 s (average, the signal must be asynchronous with the time base)

Use the SLOPE buttons if you wish to measure between any other combination of slopes.

The Timer/Counter counts the total number of pulses fed to Input-A. The positive slope of the Input-B signal starts the totalizing, and the negative slope stops it. This is always a SINGLE measurement.

Range:
0 to $1 \cdot 10^{15}$ pulses.

k on the display indicates kilo-pulses (1000) and **M** indicates Mega-pulses (1 000 000).

Use the Input-B SLOPE button if you wish to measure during a negative pulse on Input-B

The Timer/Counter counts the total number of pulses fed to Input-A. The positive slope of the first pulse on Input-B starts the totalizing, and the positive slope of the next pulse stops it. This is always a SINGLE measurement.

Range:
0 to $1 \cdot 10^{15}$ pulses.

k on the display indicates kilo-pulses (1000) and **M** indicates Mega-pulses (1 000 000).

Use the Input-B SLOPE button if you wish to measure between two consecutive negative pulses on Input-B.

The Timer/Counter counts the total number of pulses fed to Input-A. You start and stop the totalizing with the TOTALIZE START/STOP button (RESET/LOCAL). If you keep this button depressed for more than one second, the total sum will be reset.

Range:
0 to $1 \cdot 10^{15}$ pulses

k on the display indicates kilo-pulses (1000) and **M** indicates Mega-pulses(1 000 000).

The Measuring-time indicator is switched off in TOT A MAN.

CONTROL

OPERATING THE CONTROL

DISPLAY

GPIB-CODE

FUNCTION



Move function cursor to **VOLT A MAX-MIN**

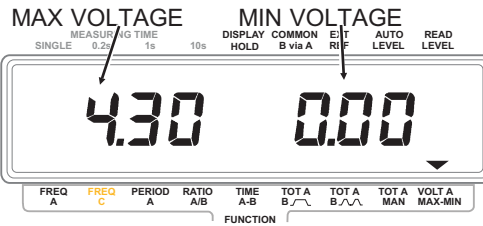

VMAX A, VMIN A
(VMAX B and VMIN B possible via Bus)

MEAS TIME



MEAS TIME is operated in the same way as the functions control, see page

MTIME <num>
where <num> is the time in seconds.

Range:
10 ms to 10 s.
0 = Single

MEAS TIME



Move the measuring-time cursor to **SINGLE**

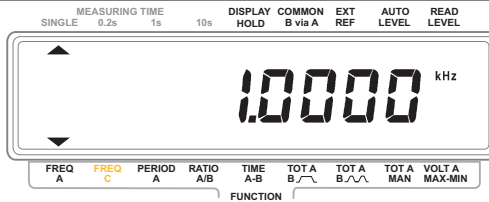

MTIME 0

MEAS TIME



Move the measuring-time cursor to **0.2 s**

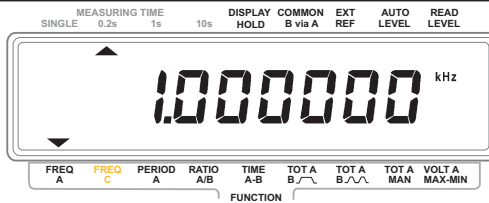

MTIME 0.2

MEAS TIME



Move the measuring-time cursor to **1 s**

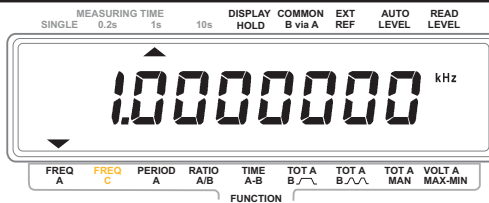

MTIME 1

MEAS TIME



Move the measuring-time cursor to **10 s**

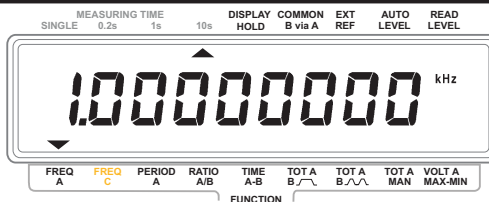

MTIME 10

FUNCTION AND RANGE

HINTS AND COMMENTS

The timer counter will measure the positive and negative peak voltage and display them as voltage relative to 0 V.



Range: -51 V to +51 V.

The attenuator will switch in and out automatically when needed during voltage measurements regardless if AUTO LEVEL is selected or not.

The set Measuring-time controls the time during which the main gate is opened, allowing pulses to enter the counting logic. A longer Measuring-time gives higher resolution readouts with more digits displayed.

If you wish to do one measurement instead of repetitive measurements, see DISPL HOLD.

The time the gate is open is not exactly the preset Measuring-time, because the Timer/Counter synchronizes the measurement with the input signal in order to measure complete periods. If the period of the input signal is longer than the set Measuring-time, the main gate does not close again until the period is completed.

When TOT A  B or TOT A  B is selected, the Measuring-time setting will be used to set the display time.

For PER A and TIME A-B exactly one period or one time interval is measured. The minimum result possible is 100 ns.

The input frequency is limited to 16 MHz for FREQ A and PER A.

The display time will be 100 ms.

If external reference is used, the EXT REF indicator will not be switched-on until after the first measurement.

When set to SINGLE and FREQ A, the Measuring-time is one cycle of the input signal or 3 ms, whichever is longest. When set to SINGLE and FREQ C, the Measuring-time is 3 ms.

A Frequency-A measurement will result in 6 to 7 digits on the display.

A Frequency-A measurement will result in 7 to 8 digits on the display.

A Frequency-A measurement will result in 8 to 9 digits on the display.

CONTROL

OPERATING THE CONTROL

DISPLAY

GPIB-CODE

RESET LOCAL



TOTALIZE A

RESET/LOCAL, a short press is enough for Reset. When the remote indicator is on, a press will cause the counter to switch back to LOCAL, i.e. control from the front panel.

TOTALIZE START/STOP, one press starts totalizing, the next press stops.

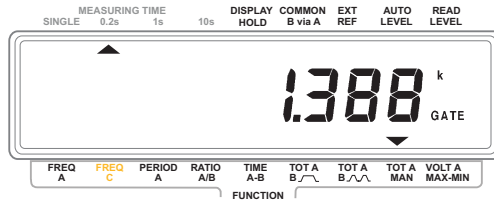

X starts a new measurement.

GATE OPEN starts and **GATE CLOSE** stops Totalize MAN.

DISPL HOLD



Switches 'on' or 'off' **DISPL HOLD** when de-pressed.

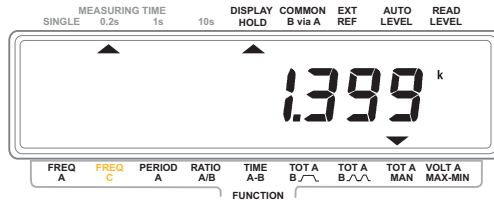

Not bus controllable, but Free-run OFF will give a similar function; See GPIB-bus operation.

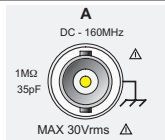



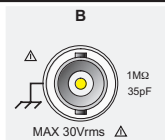

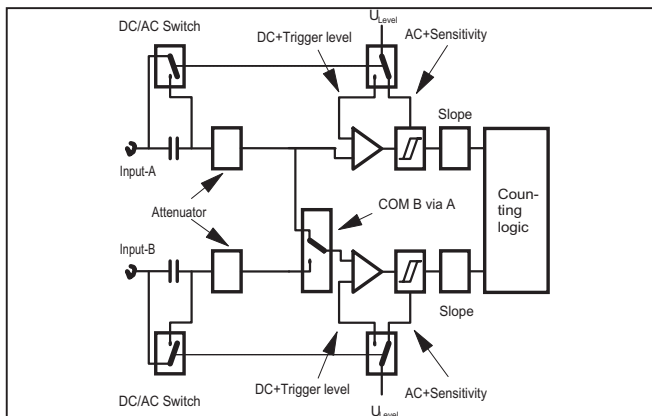

Connect the signal to **INPUT-A** via a BNC-cable.



Connect the signal to **INPUT-B** via a BNC-cable.

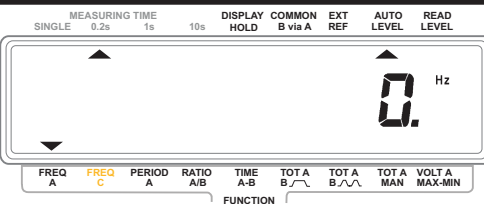

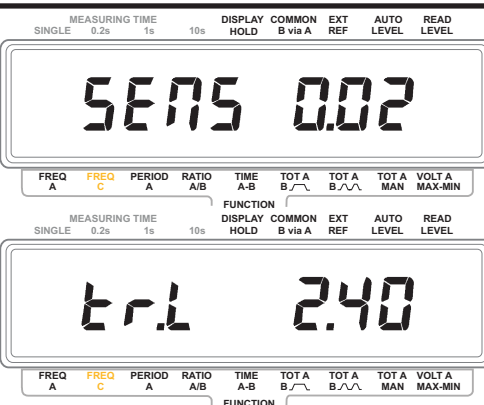
CONTROL	OPERATING THE CONTROL	DISPLAY	GPIB-CODE
<p>ATTx1 x10</p> 	<p>One ATTx1/x10 push button for each of input A and B. Switch the indicator ON to select 10 times attenuation and OFF to switch off the attenuator.</p>		<p>ATT ON ATT OFF You must first select input with INPA or INPB.</p>
	<p>One SLOPE push-button for each of input A and B. Switch the indicator ON to select negative slope, and OFF to select positive slope.</p>		<p>TRGSLP POS TRGSLP NEG You must first select input with INPA or INPB.</p>
<p>DC AC</p> 	<p>One DC/AC push-button for each of input A and B. Switch the indicator ON to select AC and OFF to select DC.</p> <p>NOTE: Sensitivity can be set when AC-coupled and Trigger Level when DC-coupled.</p>		<p>COUPL AC COUPL DC You must first select input with INPA or INPB.</p>
 <p>AUTO LEVEL</p>	<p>A depression switches the AUTO LEVEL indicator on or off.</p>		<p>AUTO ON AUTO OFF</p>
<p>SET A</p> 	<p>Depress the SET A or SET B button once and the indicator in the button switches on. Now the auto level and Read level buttons have the arrow up and down function. Another press will switch off the function.</p> <p>NOTE: Sensitivity can be set when AC-coupled and Trigger Level when DC-coupled.</p>		<p>Separate Codes for trigger level and sensitivity SENS1 =20 mV SENS2 =50 mV SENS3 =100mV TRGLVL <num> = -5.1 to +5.1 V. You must first select input with INPA or INPB.</p>

FUNCTION AND RANGE

HINTS AND COMMENTS

When the indicator in the button is OFF, the signal is un-attenuated; the trigger level range is -5 V to $+5\text{ V}$ and the sensitivity can be 0.02 , 0.05 or 0.1 V .

If Auto Level or Volt is selected, the correct attenuator setting will be selected automatically.

When the indicator is ON the signal is attenuated 10 times; the Trigger level range becomes -50 V to $+50\text{ V}$ and the sensitivity becomes be 0.2 V , 0.5 or 1.0 V .

When the button indicator is ON, the active slope of the input is changed from positive to negative.

Dual functions:

You can remove any DC-component with AC-coupling.

1) AC- or DC- coupled input.

For frequency, period, and ratio measurements: Select AC-coupling and set the sensitivity so that the hysteresis band of the Timer/Counter is about half the amplitude of the input signal.

2) Selection of variable sensitivity (AC) with 0 V trigger level or selection of variable trigger level (DC) with maximum sensitivity.

For time measurements: Select DC-coupling and set the trigger level to the desired level.

NOTE: AC coupling together with Auto Level results in maximum sensitivity and automatic trigger level setting.

The auto-level function always sets the DC trigger-level to 50% of the amplitude, it does also switch on the attenuators when needed. Auto-level is selected simultaneously for both A and B inputs.

NOTE: Auto level gives automatic trigger level setting to AC coupled inputs also.

The measuring rate is reduced to about two measurements/ second when using Auto-Level.

Use Read-Level to check what trigger-levels Auto-Level has selected

The sensitivity is decreased to 150 mVpp , and the minimum frequency is 100 Hz

For frequency, period, and ratio measurements:

If the sensitivity is too high, the Timer/Counter will be triggered by noise and interference instead of by the signal.

Select AC-coupling and set the sensitivity to about half the amplitude of the input signal.

For time measurements:

Select DC-coupling and set the trigger level to the desired level.

CONTROL

OPERATING THE CONTROL

DISPLAY

GPIB-CODE



The **READ LEVEL** push-button. When the indicator is on, the display shows the trigger levels on the display.

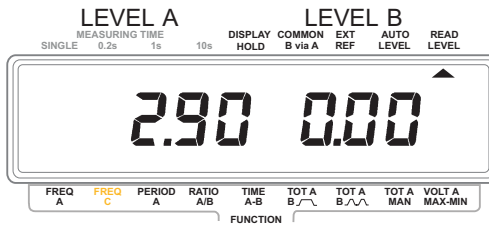

Use INPA? and INPB? to read input settings to the controller



The **COMMON B via A** push-button. When the indicator is on the signal on Input-A is also connected to Input-B.

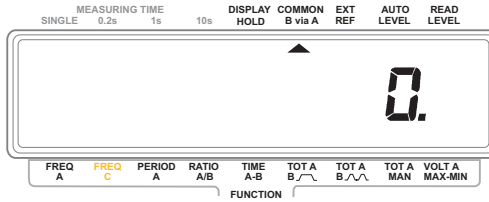

COM ON
COM OFF

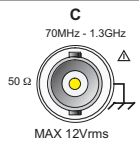

Connect the signal to **INPUT-C** via a BNC-cable.

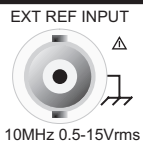

Connect an external 10 MHz frequency source to the BNC-connector on the rear panel of the Timer/Counter marked **EXT REF INPUT**

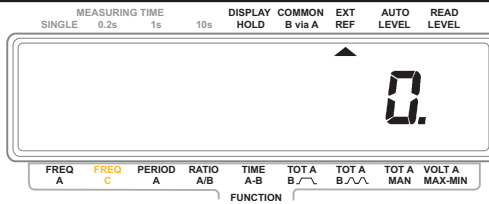

Not bus control-
lable.

FUNCTION AND RANGE

HINTS AND COMMENTS

When active, trigger levels will be displayed according to this table:

Use Read-Level to check what trigger-levels Auto-Level has selected.

	Auto Level	Manual
DC	Level selected by Auto.	Level set using Set A or SET B
AC	Level selected by auto	0 V.

When active, the signal on Input-A is also connected to Input-B.

You can use COM B via A and the manual trigger level settings to make accurate rise-time measurements:

The DC/AC and Attenuator switches for Input-A affects both Input-A and B. The Input-B DC/AC and Attenuator switches have no effect. (See figure)

1. Select DC-coupling, COM B via A and positive slope for input A and B.
2. Select VOLT A MAX-MIN and read the amplitude of the signal.
3. Calculate 10 % of the peak to peak voltage.
4. Depress SET A, use and to set trigger level A to the MIN reading plus the 10 % of Vpp.
5. Depress SET B, use and to set trigger level B to the MAX reading minus the 10 % of Vpp.
6. Select TIME A-B

Trigger level/sensitivity and Slope can be selected separately.

This is the HF-input which must be used when the FREQ-C function is selected.

RATIO C/A and RATIO C/B can be selected via the bus

Range:
70 to 1300 MHz.
Impedance:
50Ω
Sensitivity:
10 mV_{RMS} up to 900 MHz, 15 mV_{RMS} 900-1100 MHz and 40 mV_{RMS} above.
Max voltage:
12 V_{RMS}.

The Timer/Counter automatically detects if a suitable signal is connected to the EXT- REF Input-connector.

Use external reference when the measurement requires ultra-high stability.

Suitable signal:
10 ± 0.1 MHz, 0.5 to 15 Vrms Sine wave.

The Timer/Counter must still have the internal time base even if an external reference frequency is used.

If single is selected, the EXT REF indicator on the display is not switched on until after the first measurement.

Error Codes

The counter can display the following error codes if something goes wrong.

- Error OF Overflow in the counting registers. Select a shorter Measuring-time if you get this error code, unless the counter is set to TOTALIZE, then you must press reset and start again from zero.
- Error 01 RAM memory error
- Error 02 Measuring logic error
- Error 03 Internal bus error

If the counter shows one of these error codes, try switching the counter off and on again. If error code 01-03 persists, call Pendulum service. Look on the last page in this manual for Phone No. and address.

GPIB-interface Operation

Introduction

The CNT-66 can be controlled by a computer (controller) via the GPB-interface option, option 04. All functions that can be controlled from the front panel can also be controlled via the bus in a similar way, except the power switch. The additional micro-processor on the interface board has made it possible to add functions. You can obtain continuously variable Measuring-time, bus-learn, high-speed-dump etc., but these functions are only accessible via the bus.

To select a function, you send a command to the counter. We have chosen the text on the front panel as commands, wherever possible, in order to make them easy to remember. E.g. the command to select Frequency-C is FREQ C and the command to select Ratio A/B is RATIO A,B.

NOTE: The characters in a command can be in both upper and lower case.

What can I do using the Bus?

Summary

Description	Code
Source handshake	SH1
Acceptor handshake	AH1
Control function	CØ
Talker Function	T5
Listener function	L4
Service request	SR1
Remote/local function	RL1
Parallel pol	PPØ
Device clear function	DC1
Device trigger function	DT1
Bus drivers	E2

■ Source and Acceptor Handshake SH1, AH1

SH1 and AH1 simply means that the counter can exchange data with other instruments or a controller, using the bus handshake lines; DAV, NRFD, NADC.

■ Control Function, CØ

The counter does not function as a controller.

■ Talker Function, T5

The counter can send responses and the results of its measurements to other devices or to the controller. T5 means that it has the following functions:

- Basic talker.
- Talk only mode.

- It can send out a status byte as response to a serial poll from the controller.
- Automatic un-addressing as talker when it is addressed as a listener.

■ Listener Function, L4

The counter can receive programming instructions from the controller. L4 means the following functions:

- Basic listener.
- No listen only.
- Automatic un-addressing as listener when addressed as a talker.

■ Service Request, SR1

The counter can call for attention from the controller e.g. when a measurement is completed and a result is available.

■ Remote/Local, RL1

You can control the counter manually (locally) from the front panel, or remotely from the controller. The LLO, local-lock-out function, can disable the LOCAL button on the front panel.

■ Parallel Poll, PPØ

The counter does not have any parallel poll facility.

■ Device Clear, DC1

The controller can reset the counter, forcing it to default settings, via interface message DCL (Device clear) or SDC (Selective Device Clear).

■ Device Trigger, DT1

You can start a new measurement from the controller via interface message GET (Group Execute Trigger).

■ Bus Drivers, E2

The GPB interface has tri-state bus drivers.

Connecting the Controller

The bus interface connector is on the rear panel of the counter. If your counter does not have any connector, you must install the GPIB-interface option, see installation.

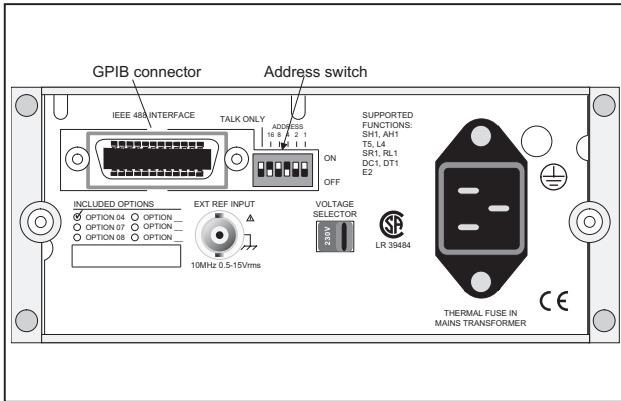

Figure 5-1 GPIB connector and address switch, the numbers above the switches indicate the significance of each switch.

Connect the controller via an IEEE-488 cable to the bus connector. If you use IEC-625 cables, an adapter is available, see ordering information at the end of this manual.

Giving the Counter an Address

The counter must have a unique address so that the controller can communicate with it. The address is selected by setting switches to the binary equivalent of the address you want. The switches are located to the right of the interface connector. The OFF position means 0 and the ON position means 1.

Ad- dress	Switch settings	Ad- dress	Switch settings	Ad- dress	Switch settings
0	00000	10*	01010	20	10100
1	00001	11	01011	21	10101
2	00010	12	01100	22	10110
3	00011	13	01101	23	10111
4	00100	14	01110	24	11000
5	00101	15	01111	25	11001
6	00110	16	10000	26	11010
7	00111	17	10001	27	11011
8	01000	18	10010	28	11100
9	01001	19	10011	29	11101
				30	11110

* Factory setting.

NOTE: 31 is the bus command for "Untalk" and should not be used. If 31 is selected the counter will work as if address 0 is selected.

Talk-Only

The leftmost switch in the address switch block is the TALK ONLY switch. If you set it to '1', the counter will output measurement results on the bus continuously. It will not react to any incoming commands.

This setting may only be used if the counter is connected to a 'Listen only' device such as a printer. Set the switch to '0' when you want normal bus communication.

Talk only is set to '0' on delivery.
The counter is now ready for bus control.

Checking the Communication

To check if the counter and the controller can communicate, address the counter and execute the following sequence: (The programming example is for an HP-85 controller.)

Type on controller:	This should happen:
REMOTE 710	The remote indicator should be switched on.
OUTPUT 710;"ID?"	Ask for the counter identity.
ENTER 710;A\$	Input result from counter.
DISP A\$	The response on the display of the controller is the identity of the counter.

If everything is OK, the counter will identify itself as:

PM6666/YZW/MN

where:

- Y = 4 if the counter has an HF-input, otherwise 0.
- Z = 3 for MTCXO, otherwise 1
- W = 6 (GPB-bus is installed)
- M = Revision No. of counter firmware
- N = Revision No. of GPB-bus firmware

Two Ways of Programming

The simplest way of programming the counter is by manually setting up the measurement you want from the front panel of the counter, then let the controller ask the counter how it is set up. The data the controller gets from the counter can be used to set up the same measurement over and over again. This method is called 'Bus-learn' and will be explained later.

The other method is to make a program message where each step of the set-up is separately specified.

Programming Checklist

Check that the following steps have been taken to ensure correct programming of the instrument.

Normally only the six first steps must be programmed.

- Do you know the current setting of the counter? If not, send device clear 'D' to get the default settings.
- Select Measuring-function; (Default: Frequency-A.)
- Select Measuring-time;(Default: 0.2 s.)
- Select Trigger-slopes; (Default on Input-A and Input-B: Positive.)
- Select Coupling; (Default on Input-A: AC.) (Default on Input-B: DC.)
- Select Trigger-level;(Default: AUTO.)

For advanced programming, check the following steps.

- Set Output separator; (Default: LF.)
- Set EOI mode; (Default: OFF.)
- Set service request(SRQ) -mask; (Default, No SRQ.)
- Select Free-Run on or off; (Default: ON.)
- If Free-Run is off, select Time-Out if desired; (Default: Infinite, programmed as 0 s.)
- Set Output-mode; (Default: Normal output format, High-speed dump OFF and MTCXO compensation ON.)

All functions and commands in the checklist will be explained later.

NOTE: You only have to program the changes from the previous set-up.

Syntax

What is a Programming Command?

A programming command consists of a header, addressing the function you want, and a body instructing the function what to do.

EXAMPLE:

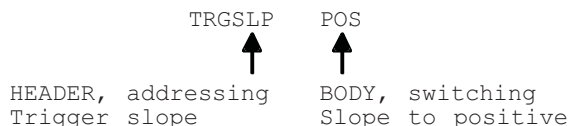

NOTE: Some programming commands consists only of the Header, e.g. trigger command 'X'.

What is a Programming Message?

A programming message is a number of programming commands with separators between them. E.g. the commands necessary to set up a measurement.

EXAMPLE: PER A;MTIME 0

Input Separator

All communication between the counter and the controller uses sequences of ASCII-characters terminated by a separator. Input separators are the separators sent by the controller. They are used in four different places:

The separators in the example above are the ones normally used in respective place. The counter will however accept any one in any place.

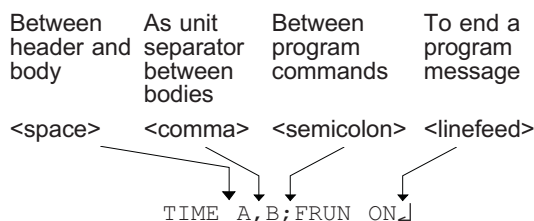

The following separators will also work in any of the four places: colon, CR, ETB, ETX, the separator selected as output separator, as well as an active EOI-signal.

Order of Commands in a Program Message

Normally, the programming commands in a programming message can be placed in any order.

However, the following commands must always be placed at the end of a program message since any command sent after them will disable the selection:

INPA?	MEAC?	FNC?	X
INPB?	BUS?	ID?	OUTM 4

These commands will be ignored if found anywhere but in the end of a message.

<number>

In some program commands, the body is replaced by the term <number> or <num>. Here you must enter a numerical value. <number> can be entered in any format you like e.g. 1.23 can also be entered as 0.000000123×10^7 or 1230000×10^{-6} . If you enter more digits than the counter needs, your entry will be truncated. The counter will stop if an entry is out of the counters range. To proceed, the status message 'Programming error' must be reset, see 'Status byte'.

Selecting Output Separator

Output separators terminate messages from the counter to the controller. The separator needed is different for different controllers; see the Operators' Manual for your controller.

At power on, the output separator of the counter is linefeed 'LF' (10_{decimal}).

The output separator can be changed by sending SPR <number> to the counter. <number> is the decimal value of the ISO (ASCII)-code for the desired separator. It can be 0-26, 28-31, ESC code, 27, is not accepted.

Only one <number> can be entered as separator. If you want the combination of CR+LF (13_{dec} + 10_{dec}), it is selected by 'SPR 255'.

EXAMPLE:

```
SPR 13 changes the output separator to CR
SPR 255 changes the output separator to CR+LF
```

The counter can signal EOI together with the last output separator in responses and output data.

EOI ON switches on the function.

EOI OFF switches it off.

Default setting is EOI OFF.

The selected separator and EOI will not be altered by LOCAL from the front panel nor by LOCAL or 'Device clear' from the bus.

How to Select Function

Standard Functions



Functions are selected by sending the appropriate function command to the counter, e.g. FREQ A. The space between FREQ and A indicates the input separator that you always must insert.

Function	Command	Comment
Frequency A	FREQ A	Default
Frequency C	FREQ C	
Period A	PER A	
Ratio A/B	RATIO A,B	
Time A-B	TIME A,B	
Totalize A Gated by B	TOTG A,B	
Totalize A Start/stop by B	TOTS A,B	
Totalize A Manually	TOTM A	See 'Totalize start/stop'
Volt A max	VMAX A	
Volt A min	VMIN A	

The function cursor on the display of the counter will jump to the selected function.

Functions Accessible via Bus Only

When you have a GPIB interface you will get the following new functions:

Function	Command	Function cursor indicates
Frequency B	FREQ B	FREQ A
Time interval B-A	TIME B,A	TIME A-B
Totalize B Manually	TOTM B	TOT A MAN
Totalize B Gated by A	TOTG B,A	TOT A  B
Totalize B Start/stop by A	TOTS B,A	TOT A  B
Ratio B/A	RATIO B,A	RATIO A/B
Ratio C/A	RATIO C,A	RATIO A/B
Ratio C/B	RATIO C,B	RATIO A/B
Volt B max**	VMAX B	VOLT A MAX-MIN
Volt B min**	VMIN B	VOLT A MAX-MIN

** Don't use VMAX B or VMIN B together with COM B via A to measure the voltage on input A. The results will be unreliable.

When the counter switches to LOCAL, the function indicated by the Function-cursor will be selected.

The counter will not return to the 'bus only' function when it returns to remote. To return to the 'bus only' function you must re-program the counter.

The specifications of some 'bus-only' functions differ from the specifications of its similar front-panel selectable function. See 'Specifications'.

Selecting Measuring-Time

The Measuring-time can be set to any value between 10 ms and 10 s, or SINGLE-measuring. Any value below 10 ms will be interpreted as SINGLE. Values above 10 s will be out of range and cause an error. The program command is MTIME <number>. Always enter the Measuring-time in seconds. The entered value will be truncated to the nearest 10 ms increment.

Meas Time	Command	Comment
0.2 s	MTIME 0.2	Default
10 ms	MTIME 0.01	You will not be able to see the gate indicator blinking if the Measuring-time is below 50 ms
7.34567s	MTIME 7.34567	The Measuring-time will be 7.34 s.
2 ms	MTIME 0.002	Out of range
SINGLE	MTIME 0	A display time of 50 ms is set so that you can see the Gate-indicator.
25 s	MTIME 25.0	Out of range and error, the counter will stop. It can indicate programming error by sending an SRQ if selected in the SRQ-mask.

The Measuring-time cursor on the display will indicate 0.2 s for all programmed Measuring-times except SINGLE, which will be indicated as usual.

Selecting Input settings

Before selecting input settings you must tell the counter which input you want to address:

Input	Command	Comment
A	INPA	Default setting
B	INPB	

Now you can send the input setting commands:

Attenuator	Command	Comment
1	ATT OFF	Default
10	ATT ON	

Trigger slope	Command	Comment
Positive	TRGSLP POS	
Negative	TRGSLP NEG	

Coupling	Command	Comment
AC	COUPL AC	Default on A
DC	COUPL DC	Default on B

Sensitivity	Command	Comment
	SENS <number>	
20 mV	SENS 1	Default
50 mV	SENS 20	
100 mV	SENS 3	

If ATT10 is selected sensitivity will be 0.2 V 0.5 V and 1.0 V

Trigger level	Command	Comment
Volt	TRGLVL	<num><num> = trigger level in Volts. Range: 5.10V to +5.10V. Minimum increment: 0.02 V. Default 0 V

* If ATT10 is selected, Trigger level range will be 51 V to +51 V and the minimum increment 0.2 V.

The following commands affect both inputs regardless of which input is selected:

Auto level	Command	Comment
Automatic	AUTO ON	Default
Manual	AUTO OFF	

* If AUTO is ON, the attenuator, trigger level and sensitivity settings are controlled by AUTO. If any of these parameters are reprogrammed when AUTO is ON, the new setting will be stored and used when AUTO is switched OFF. If the controller asks for program data out during AUTO, the answer will be the selections made by AUTO.

Common B via A	Command	Comment
on	COM ON	
off	COM OFF	Default

When COM ON is selected, the AC/DC and attenuator settings of Input-A will affect both channels. If AC/DC or the attenuator of input-B is reprogrammed during COM ON, the setting will be stored and used when COM is switched OFF. The program data out for Input-B will be the programmed settings, not the Input-A settings used during COM ON.

Totalize Start/Stop

When TOT A or TOT B manual is selected, the gate is opened and closed by the controller instead of by pressing the button on the front panel. To start the counting after selecting TOTM A or TOTM B, the gate must be opened.

Totalize	Command	Comment
Start	GATE OPEN	Starts counting
Stop	GATE CLOSE	Stops Counting. Default

NOTE: Multiple GATE OPEN/GATE CLOSE will accumulate the results in the counting registers. Any other command but GATE OPEN/GATE CLOSE will stop the totalizing and reset the counting registers to zero.

Free-Run/Triggered

The counter can work in two different ways:

1. **Free-Run**, where it starts a new measurement as soon as the previous measurement is finished.

The first measuring result that is ready after the counter receives a read command, will be sent to the controller. When the result has been read, the output buffer is reset to zero until a new result is ready. One and the same measuring result can only be read once.

2. **Triggered**, where the counter waits for trigger command GET or 'X' from the controller before it starts a measurement. When the measurement is completed, the counter will wait until the controller reads the measuring results, then the output buffer is reset. The function is the same as when Displ Hold is selected from the front panel and you start a new measurement by pressing the Reset button.

Free run	Command	Comment
Off	FRUN OFF	This function is sometimes called Triggered-Mode
On	FRUN ON	TRIG OFF gives the same result. Default.

Free-Run ON or OFF will not be indicated on the display. When the counter switches to LOCAL, Free-Run will always be ON but when the counter switches back to remote, it will return to its previously programmed settings.

Time-Out

When Free-Run is switched off it is possible to set a time-limit (time-out) between the start of a measurement and the time when a result is expected to be ready. If no result is achieved before the set time is out, the counter can output a Service Request, SRQ. Time-Out must be selected in the SRQ-mask; see 'Service Request'. The programming command is TOUT <number>. The timeout can be set to any value between 100 ms and 25.5 s, the minimum increment is 100 ms.

Time-Out	Command	Comment
100 ms	TOUT 0.1	Time-Out is only intended to be used with Free-Run off*.
Off	TOUT 0	Always send this command when Free-Run is switched on. Default.

Time-Out is not indicated on the display. When the counter switches to LOCAL, Time-Out is off, but when switched to remote again, the set Time-Out will be active again.

- * Time-out can be switched on when free-run is on but it will not serve any purpose.

Bus Triggering

'X' will always cause the counter to start a new measurement. X will work as group execute trigger, GET. 'X' must always be placed in the end of a program message.

Service Request

The counter can send a service request, SRQ, when it wants service from the controller. After an SRQ, the controller must execute a serial poll which means that it must ask each of the instruments for status information until it finds the SRQ-giving instrument, evaluate the Status-byte of the instrument and then make a decision what to do.

To enable the counter to send service requests, you must set an SRQ-mask telling the instrument which conditions will cause SRQ.

Command	Comment
MSR <number>	<number> is a decimal value depending on selected SRQ reasons.

Bit	Decimal value	Reason for SRQ.
7	128	Not used
6	64	Time-Out
5	32	Hardware fault
4	16	Programming error
3	8	Measuring stop enable
2	4	Measuring start enable
1	2	Ready for triggering
0	1	Measuring result ready*

* If SRQ for Measuring result ready is selected, the counter will stop and wait until the controller fetches the result before a new measurement can start.

Write down the binary word for the required SRQ, then convert it to a decimal value and insert the value as <number>.

EXAMPLE: If you want SRQ to be sent when the time-out elapses, when the counter is ready for triggering and when the result is ready, the binary word required is 01000011 which is decimal 67; see table below.

Bit	Value if the bit is 1	Example
		<i>Binary word</i>
		<i>Decimal value</i>
7	128	0
6	64	1
5	32	0
4	16	0
3	8	0
2	4	0
1	2	1
0	1	1
		+ 1
		Meas. Result ready
		67

Send MSR 67 to the counter.

Status Byte

The counter sends its status byte to the controller on a serial poll. The bits in the status byte reflects different events or conditions in the counter. There are two types of status bits:

A Conditional Bit indicates the current condition of what its monitoring, all the time.

An Event Bit indicate that an event has occurred. When the event occurs, the bit is set to 1. It is not reset to 0 until a new measurement starts.

The different bits indicate the following information:

Bit	Function
7	Always 0
6	1 = SRQ has been sent' otherwise 0 (Event bit)
5	Abnormal bit. Always 0 during normal measurements 1 if something is wrong. Affects bit 0-3
4	0 = Main Gate closed 1 = Main Gate open**
3-0	Depends on Abnormal bit see below (Event bits.)

Bit	Abnormal bit = 1	Abnormal bit = 0
3	Not Used	Measuring stop enable
2	Time-Out	Measuring start enable
1	Hardware fault	Ready for triggering
0	Programing error	Measuring result ready

* Only if SRQ-mask is set for Service-Request.

** This is a conditional bit that monitors the Main-Gate in the counter. When TOT MAN is selected the bit will always be 0.

Measuring Start Enable indicates that the counter logic is ready to start a measurement.

Measuring Stop Enable indicates that the counter logic is ready to stop a measurement.

These bits can be used to detect if the input signal to the counter is present; If the counter never stops it's measurement and the status byte stops at:

XX00X1XX No input signal. The measurement is ready to start (bit 2 = 1) but the Main Gate has not opened (bit 4 = 0)

XX011XXX Input signal lost during measurement. The measurement is ready to stop (bit 3 = 1) but the main gate is still open (bit 4 = 1)

(X = don't care)

NOTE: SRQ is normally not used for these bits.

Ready For Triggering indicates that all preparations for a measurement is completed. The preparation time depends on selected functions. It can be up to 700 ms (when auto triggering is selected).

If triggered mode is selected, the counter waits to be triggered, otherwise it proceeds with the measurement. You can have the SRQ-mask set for SRQ at ready for triggering. This way the controller knows when it is possible to trigger the counter.

Measuring Result Ready indicates that the measurement and calculation of the result is completed and that the result is present in the output buffer. If SRQ for is selected for this event, or Free-run is OFF, the counting will stop until the controller has read the result.

Programming Error is generated if the counter receives messages with illegal syntax or values out of its range.

If 'Programming error' is generated, the counter will stop measuring. It will continue to receive and store correct programming messages and use them when the error status is reset and a new measurement starts.

Correct the program before resetting the status message.

Use one of the following bus commands to reset the status byte:

Go to local (GTL), Device clear (DCL) or selective device clear (SDC).

Any of the following messages will have the same effect on the counter:

D, FNC?, MEAC?, INPA?, INPB?, ID? or BUS?.

A serial poll will also reset the status message if the SRQ mask is set for 'SRQ at Programming error'.

Hardware Fault is generated when the counter displays the codes described in 'Error codes' in the 'Operating instructions' in this manual.

Time-Out is generated when the set time-out period has elapsed.

Possible Status Messages

■ Normal Measurement

The status byte changes as follows during a normal measurement:

0, 2, 6, 22, 30, 14, 15, 0,

Decimal	Binary 76543210	Important bits (X = don't care)	Comment
0	00000000		Preparing a measurement or, High-speed dump or Volt measurements in progress.
2	00000010	XX0XXX1X	Preparations ready. If Free-run OFF
6	00000110	XX0XX1XX	Measuring start enable.
22	00010110	XX01XXXX	Main-Gate open
30	00011110	XX0X1XXX	Measuring stop enable.
14	00001110		Calculating the measuring result.
15	00001111	XX0XXXX1	Measuring result ready

Error conditions

Decimal	Binary 76543210	Important bits (X = don't care)	Comment
33	00100001	XX1XXXX1	Programming error
34	00100010	XX1XXX1X	Hardware fault
36	00100100	XX1XX1XX	Time-out

* If Service request (SRQ) is enabled for an event, the decimal value of the status message for that event will be increased by 64. The reason for this is that bit 6 will be set to one at the same time as the bit indicating the event.

Output Mode

Setting the output mode selects the format in which the counter will output measuring results to the controller. Select output mode by sending OUTM <number> where <number> is a decimal value between 0 and 4 depending on the selected output mode.

<number>	High-speed dump	Output format	MTCXO compensation
0	OFF	NORMAL	ON
1	OFF	SHORT	ON
2	OFF	NORMAL	OFF
3	OFF	SHORT	OFF
4	ON	FOR HIGH SPEED DUMP	OFF **

Default <number> is 0, when switching to local and back again, the <number> will be reset to 0.

The MTCXO compensation can be switched off to increase the measuring speed, providing a result with five digits accuracy is sufficient. The time gained will be up to 400 ms/measurement.

** Must be in the end of a program message.

Output Format

Normal

When you select normal output format, the output will be as follows:

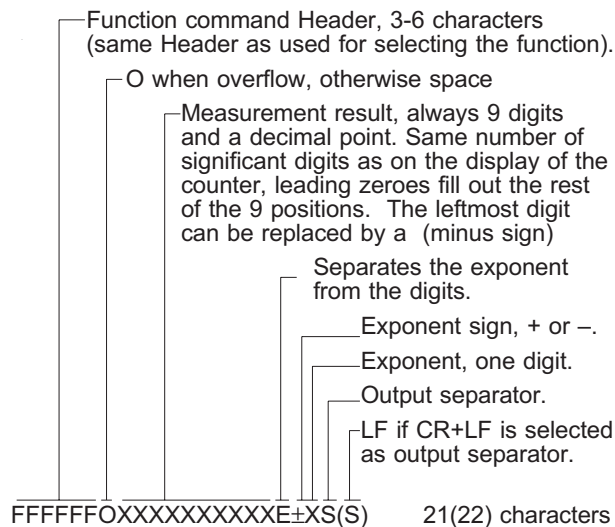

EXAMPLE:

Normal operation:
 PER 000001.667E-4
 Overflow:
 PER 09.9999999E+9

Short

Short format means that function command and leading zeros are not sent to the controller. When you select short output format, the number of digits may vary depending on the measurement result. The example below shows a result with five significant digits:

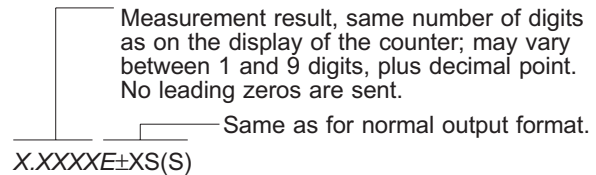

EXAMPLE:

Normal operation:
 1.667E-4
 Overflow:
 9.9999999E+9

High-speed Dump

The most time-consuming part of a measuring cycle is calculating the result. The calculations limit the number of possible results/second to about 5, even when the Measuring-time is short.

When however High-Speed dump is selected all calculations are left to the controller instead, and the counter can concentrate on measuring at a rate of over 100 measurements/second.

High-speed dump cannot be used for voltage measurements nor for Totalize manually. MTCXO compensation is not possible.

Starting

NOTE: Always make sure you have input signal and that the input triggers correctly before turning on high-speed dump! (See Stopping below).

If Triggered Mode is OFF When High-speed dump is programmed the counter will immediately start transmitting results, so the OUTM 4 command must always be placed at the end of the program message.

If Triggered Mode is ON After receiving OUTM 4 the counter waits for bus command GET before it starts.

NOTE: The minimum time between OUTM 4 and GET is 70 ms.

Stopping

Any programming command from the controller will end High-Speed dump. High-speed dump is stopped inbetween two measurements. If you switch on high-speed dump without having an input signal, the counter must be switched off/on to regain control over the counter.

NOTE: The Power-switch is the only front panel control that will stop High-Speed dump, the LOCAL-button will not have any effect.

■ Output Format

The output format will always be two letters followed by 12 hexadecimal digits. The two letters will tell the controller how to evaluate the twelve hex-digits, which represent the contents in the internal registers of the counter.

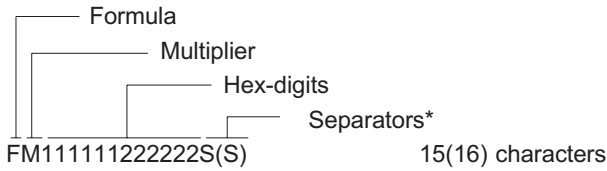

* The counter cannot signal EOI together with the output separator when High-speed dump is selected.

■ Hex-digits

All 12 digits together represent register 3.

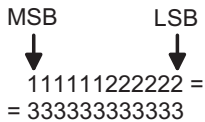

When the digits are divided into two groups, the first six digits represent register 1 and the last six digits represent register 2.

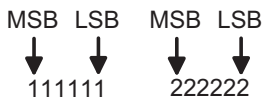

Formula

Depending on the selected measuring function different calculations must be made to convert the register contents to readable measuring results.

The first letter (F) in the output data indicates which formula you must use.

If 'F'='	Use this formula
C	$\frac{Reg.2 \times 10^7}{Reg.1}$
F	$Reg.3$
G	$\frac{Reg.2 \times 10^7}{Reg.1}$
I	$\frac{Reg.1 \times 10^{-7}}{Reg.2}$
J	$Reg.3 \times 10^{-7}$
K	$\frac{Reg.2 \times 10^{-7}}{Reg.1}$

Multiplier

The second letter (M) in the output data represents a multiplier which you must multiply the results by before presenting it.

If 'M'='	Multiply results by:
H	60
L	256
N	0.1
O	10
P	1

EXAMPLE 1:

The following HP-85 program sets up a High-Speed dump Single-period measurement.

```
OUTPUT 710;"PER A,MTIME 0"
ENTER 710;AS
AS
PER 000001.667E-4
OUTPUT 710;OUTM 4
ENTER 710;AS
AS
JP000000000683
```

'J' means that you must use formula J which is: $Reg.3 \times 10^{-7}$

000000000683 is the hex-contents of register 3. The register contents must be converted to a decimal number and entered in the formula;

$$683_{Hex} = 6 \times 16^2 + 8 \times 16 + 3 = 1667_{Decimal}$$

The result is 1667×10^{-7} . which you must multiply by "Multiplier P", which is 1, to get the measuring result.

$$1667 \times 10^{-7} \times 1 = 1667 \times 10^{-4} s = 166.7 \mu s$$

EXAMPLE 2:

The following HP-85 program sets up a High-Speed dump Frequency A measurement with 1 s Measuring-time.

```
OUTPUT 710;"FREQ A,MTIME 1"
ENTER 710;AS
AS
FREQ 006.000006E3
OUTPUT 710;OUTM 4
ENTER 710;AS
AS
CO98555B000257
```

Formula 'C' is: $\frac{Reg.2 \times 10^7}{Reg.1}$

98555B is the hex-contents of register 1, and 000257 is the hex-contents of register 2. Both register contents must be converted to decimal numbers and put into the formula;

$$\frac{(2 \times 16^2 + 5 \times 16 + 7) \times 10^7}{9 \times 16^5 + 8 \times 16^4 + 5 \times 16^3 + 5 \times 16^2 + 5 \times 16 + 11} = 600.0006209...$$

This number is multiplied by multiplier 'O' to get the measuring result:

$$600.0006209 \times 10 = 6000.006209 = 6.000006209 \times 10^3 \text{ Hz}$$

How many digits are significant?

Select the formula for 'LSD displayed' in the 'Specifications'. There are different formulas for different measurements.

Frequency:

$$\text{LSD displayed: } \frac{2.5 \times 10^{-7} \times 6000 \dots}{1} = 0.0015$$

$$\text{LSD} = 0.001 \text{ Hz}$$

The result is $6.000006 \times 10 \text{ Hz}$

Bus Learn

- Set the counter to LOCAL and select the functions you want from the front panel.
- If required, set the counter to Remote and program special bus-functions from the controller.
- Check that the counter/controller performs the intended functions.
- If it does, send the five queries from the controller to the counter and store the responses in the controller for later use.

These are the five queries:

Query	Response	Max No. of characters
FNC?	Functions setting; e.g. FREQ A9	9
MEAC?	Measurement control; MTIME <number>,FRUN ON TOUT <number>	20 9
INPA?	Input A settings; TRGSLP POS,ATT OFF COUPL AC,AUTO OFF* TRGLVL <number>,SENS 1	18 17 19
INPB?	Input settings; TRGSLP POS,ATT OFF B COUPL DC,COM OFF* TRGLVL <number>,SENS 1	18 16 19
BUS?	Bus interface commands; MSR <number>,OUTM <number> EOI OFF,SPR <number>	16 15

As you can see, the responses are the same commands as you use for normal programming. So if you have to change anything in a program made using bus learn, or add functions which are not selectable from the front panel, these program messages can easily be edited in the controller.

NOTE: MEAC? and BUS? result in a response sent as two lines, each terminated by the selected separator. INPA? and INPB? result in a response sent as a three line messages.

NOTE: The counter will stop measuring until all lines of the response have been read or the response has been terminated.

NOTE: The query command must always be the last command in a program message.

- * If AUTO or COM is switched ON, the responses to INPA? and INPB? must be interpreted in a different way, see 'Selecting Input settings'.

Terminating a Response

It is not necessary to read all output lines. Any program message will terminate the response.

Programming Data Out

Any one of the queries used for Bus Learn can be used to ask the counter about its current setting, see 'Bus Learn' above.

What Happens When I Switch to Local?

Switching to LOCAL causes the counter to adapt the settings indicated on the display, see 'How to select function'. This means that the counter will never have settings in LOCAL which are not possible to set via the front panel.

When switching to remote again, the LOCAL-setting will remain. Bus-functions like SRQ mask, output separator, EOI, etc. will not be altered by switching to LOCAL and back again.

Summary of Bus Commands

Function Selecting Commands

FREQ A	Frequency measurement on Input-A
FREQ B	Frequency measurement on Input-B
FREQ C	Frequency measurement on Input-C
PER A	Period on Input-A
TIME A, B	Time interval A to B
TIME B, A	Time interval B to A
TOTG A, B	Totalize A, gated by Input-B
TOTG B, A	Totalize B, gated by Input-A
TOTS A, B	Totalize A, started and stopped by B
TOTS B, A	Totalize B, started and stopped by A
TOTM A	Totalize A, start/stop by GATE OPEN/CLOSED on the bus.
TOTM B	Totalize B, start/stop by GATE OPEN/CLOSED on the bus
RATIO A, B	No. of pulses on A No. of pulses on B
RATIO B, A	No. of pulses on B No. of pulses on A
RATIO C, A	No. of pulses on C No. of pulses on A
RATIO C, B	No. of pulses on C No. of pulses on B
VMAX A	Positive peak voltage on Input-A
VMIN A	Negative peak voltage on Input-A
VMAX B	Positive peak voltage on Input-B
VMIN B	Negative peak voltage on Input-B
FNC?	Output the current function setting

Input Setting Commands

INPA	Selects Input-A
INPB	Selects Input-B
TRGSLP POS	Triggering on positive slope
TRGSLP NEG	Triggering on negative slope
COUPL AC	AC coupling
COUPL DC	DC coupling
COM ON	A and B common via Input-A
COM OFF	A and B separated
SENS <num>	<num> = 1 gives 20 mV sensitivity <num> = 2 gives 50 mV sensitivity <num> = 3 gives 100mV sensitivity.
TRGLVL<num>	Trigger level, +5.10 V to -5.10 V. = polarity sign. <num> = level in Volt.
AUTO ON	Automatic trigger level selection **
AUTO OFF	Trigger level selection via bus **
ATT OFF	Attenuation 1
ATT ON	Attenuation 10
INPA?	Output the current Input-A settings
INPB?	Output the current Input-B settings

Measurement Control Commands

GATE OPEN	Starts the totalizing in TOTM A and TOTM B
GATE CLOSE	Stops totalizing
MTIME <num>	Set Measuring-time. <num> = 0.01 to 10 s. 0 = SINGLE
FRUN ON	Selects Free-Run
FRUN OFF	Selects Triggered mode
TRIG OFF	Selects Free-Run
TRIG ON	Selects Triggered mode
TOUT <num>	Sets Time-Out. <num> = 0.1 to 25.5 s. 0 = Time-Out OFF
MEAC?	Output the current Measurement control settings ***

Bus Related Commands

OUTM <number>

<number>	High-speed dump	Output format	MTCXO compensation
0	OFF	NORMAL	ON
1	OFF	SHORT	ON
2	OFF	NORMAL	OFF
3	OFF	SHORT	OFF
4	ON	FOR HIGH SPEED DUMP	OFF ***

MSR <num>	Sets SRQ-mask, see 'Service request'
EOI ON	Selects EOI-mode ON.
EOI OFF	Selects EOI-mode OFF
SPR <num>	Select output separator, see 'Output separators'
X	Device trigger, starts a new measurement ***
D	Device clear, returns to default settings
BUS?	Output the current bus related settings ***
ID?	Output identity and which options are installed ***

* Not available in LOCAL mode.

** Affect both inputs independent of INPA/INPB.

*** This command must be placed at the end of a program message.

Programming Examples

For HP-85 Controller

This program illustrate high measuring rate obtained with High-speed dump.

The actual measuring function is selected by the user in Local-mode. When the program runs, two beep's can be heard from the HP-85, Between these beep's, the counter performs 500 measurements and the result of each measurement is transferred from the counter to the HP-85.

The output rate is approximately 125 readings/second in this example.

```

10 ! DEMO PROGRAM DUMP MODE
20 ! CNT-66 WITH HP85 AS
30 ! CONTROLLER
40 ! DUMP MODE WITH FREE RUN ON
50 CLEAR
60 DIM Z$[7508] ! BUFFER FOR 500
  MEASUREMENTS WITH 15 BYTES
70 DIM B$[14]
80 IOBUFFER Z$
90 LOCAL 710
100 DISP "SELECT FUNCTION IN LOCAL MODE!"
110 DISP "MEASURING TIME WILL BE"
120 DISP "SELECTED BY HP85 (SINGLE)!"
130 DISP "ANSWER Y WHEN READY TO START!"
140 INPUT A$
150 IF A$<>"Y" THEN 130
160 DISP "MAKE 500 MEASUREMENTS"
170 OUTPUT 710 ;"TRIG OFF,MTIME 0,OUTM 4"
180 BEEP
190 E=TIME
200 TRANSFER 710 TO Z$ FHS ; COUNT 7500
210 F=TIME
220 TIME
230 DISP "READY! ELAPSED TIME:";F-E;"s"
240 ! SHOW 5 RESULTS"
250 DISP "FIRST 5 RESULTS:"
260 FOR K=1 TO 5
270 ENTER Z$ ; B$
280 ! GET FORMULA CHARACTER
290 F$=B$[1,1]
300 ! GET MULTIPLYER CHARACTER
310 M$=B$[2,2]
320 ! EVALUATE REGISTER 1
330 R1=0
340 FOR I=1 TO 8
350 S=NUM(B$[I,I])-48
360 IF S>=10 THEN S=S-7
370 R1=R1*16+S
380 NEXT I
390 ! EVALUATE REGISTER 2
400 R2=0
410 FOR I=9 TO 14
420 S=NUM(B$[I,I])-48
430 IF S>=10 THEN S=S-7
440 R1=R2*16+S
450 NEXT I
460 ! EVALUATE RESULT
470 IF F$="C" THEN R=10000000*R2/R1

```

```

480 IF F$="F" THEN R=R1*16^6+R2
490 IF F$="G" THEN R=R2/R1
500 IF F$="I" THEN R=.0000001*R1/R2
510 IF F$="J" THEN R=.0000001*(R1*16^6+R2)
520 IF F$="K" THEN R=.0000001*R2/R1
530 IF M$="H" THEN R=R*60
540 IF M$="L" THEN R=R*256
550 IF M$="N" THEN R=R/10
560 IF M$="O" THEN R=R*10
570 IF M$="P" THEN R=R*1
580 DISP B$,R
590 NEXT K
600 LOCAL 710
610 END

```

.Example of a result:

```

MEASURING TIME WILL BE
SELECTED BY HP85 (SINGLE)!
ANSWER Y WHEN READY TO START!
?
Y
MAKE 500 MEASUREMENTS
READY! ELAPSED TIME: 3.927 S
FIRST 5 RESULTS:
JP0000000000031          .0000049
JP0000000000031          .0000049
JP0000000000030          .0000048
JP0000000000031          .0000049
JP0000000000031          .0000049
.12751

```

For IBM PC with PM 2201

Example 1

The following example runs on an IBM compatible PC equipped with a PM 2201 GPIB interface. The installation and starting up of the PC program is not described, only the application program.

The program sets up the counter for 10 Period A measurements and presents the average result on the screen.

```

100 'DEMO PROGRAM (NO 1)
110 'CNT-66 AND IBM PC
120 'WITH PM2201 GPIB INTERFACE
130 'AS CONTROLLER
140 CLS 'CLEAR SCREEN
150 AD=7 'ADAPTOR NUMBER
160 ADDR=710 'COUNTER ADDRESS
170 SC=1 'SYSTEM CONTROLLER
180 RES$ = SPACES(25) 'RESULT
190 ACT = 0 '# READ CHARACTERS IN RES$
200 MAX = 24 'MAX CHARACTERS TO READ IN RES$
210 CALL IOINIT(AD,SC) 'INIT INTERFACE
220 TIME=10 'TIMEOUT AFTER 10 SECONDS
230 CALL IOTIMEOUT (AD,TIME) 'SET TIMEOUT
240 CALL IOCLEAR(ADDR) 'SEND SDC
250 'SELECT PERIOD A, TRIGGERED MODE
260 'AND 1 S MEASURING-TIME
270 SEND$ = "PER A,TRIG ON,MTIME 1"
280 LENGTH=LEN(SEND$)
290 CALL IOOUTPUTS(ADDR,SEND$,LENGTH)
300 Z=0
310 'INPUT 10 SAMPLES
320 FOR i = 1 TO 10
330 CALL IOTRIGGER(ADDR) 'TRIGGER COUNTER
340 CALL IOENTERS(ADDR,RES$,MAX,ACT) 'READ
    RESULT
350 Z = Z + VAL(MID$(RES$,8,13))
360 NEXT I
370 PRINT "AVERAGE: ";Z/10;"S"
380 CALL IOLOCAL(ADDR) 'GO TO LOCAL
390 END
    
```

Example of a result:

```

AVERAGE:          9.98004E-06 S
OK
    
```

Example 2

This program example illustrates the 'program data out' feature of CNT-66. By asking a set of queries, the counter responds with its current setup. The output format of these answers to the queries is identical to the programming command format. The answers can be stored and used later for reprogramming (bus learn).

```

100 'DEMO PROGRAM
110 'CNT-66 AND IBM PC WITH PM2201
120 GPIB INTERFACE AS CONTROLLER
130 AD=7 'ADAPTOR NUMBER
140 ADDR=710 'COUNTER ADDRESS
150 SC=1 'SYSTEM CONTROLLER
160 CALL IOINIT(AD,SC) 'INIT INTERFACE
170 TIME=10 'TIMEOUT AFTER 10 SECONDS
180 CALL IOTIMEOUT(AD,TIME)
    
```

```

190 CLS 'CLEAR SCREEN
200 'ASK FOR AND PRINT PROGRAM DATA
210 PRINT "COUNTING SETTING:"
220 S$ = "FNC?"
230 GOSUB 520
240 A=1
250 GOSUB 550
260 S$ = "MEAC?"
270 GOSUB 520
280 A=2
290 GOSUB 550
300 S$ = "BUS?"
310 GOSUB 520
320 A=2
330 GOSUB 550
340 S$ = "INPA?"
350 PRINT "INPA:"
360 GOSUB 520
370 A=1
380 GOSUB 550
390 S$ = "INPB?"
400 PRINT "INPB:"
410 GOSUB 520
420 A=1
430 GOSUB 550
440 S$ = "ID?"
450 PRINT
460 PRINT "COUNTER TYPE:"
470 GOSUB 520
480 A=1
490 GOSUB 550
500 CALL IOLOCAL (ADDR) 'GO TO LOCAL
510 END
520 L=LEN(S$) 'LENGTH OF STRING TO SEND
530 CALL IOOUTPUTS(ADDR,S$,L) 'OUTPUT STRING
540 RETURN
550 FOR I = 1 TO A
560 MAX=25
570 ACT=0
580 RES$=SPACES(25)
590 CALL IOENTERS(ADDR,RES$,MAX,ACT)
600 B$ = LEFT$(RES$,ACT)
610 PRINT B$;
620 NEXT I
630 RETURN
    
```

Example of a result:

```

COUNTER SETTING:
TIME  A;B
MTIME 1.00,FRUN ON
TOUT 00.0
MSR 000,OUTM 000
EIO OFF,SPR 010
INPA:
TRGSLP NEG
INPB:
TRGSLP POS
    
```

```

COUNTER TYPE:
PM6666/016/22
Ok
    
```

Example 3

This program prompts the user to input a programming sequence. The sequence is then sent to the CNT-66 and the corresponding measuring result is read.

```

100 'DEMO PROGRAM
110 'CNT-66 AND IBM PC WITH PM2201
120 'GPIB INTERFACE AS CONTROLLER
130 CLS 'CLEAR SCREEN
140 AD=7 'ADAPTOR NUMBER
150 ADDR=710 'COUNTER ADDRESS
160 SC=1 'SYSTEM CONTROLLER
170 CALL IOINIT(AD,SC) 'INIT INTERFACE
180 TIME=10 'TIMEOUT AFTER 10 SECONDS
190 CALL IOTIMEOUT (AD,TIME)
200 CALL IOCLEAR(ADDR) 'SEND SDC
210 PRINT "INPUT YOUR PROGRAMMING
MESSAGE?"
220 PRINT "(TO QUIT THE PROGRAM, ANSWER *)"
230 LINE INPUT SS
240 L=LEN(SS) 'LENGTH OF STRING TO SEND
250 IF L<>1 GOTO 280
260 IF SS<>"*" GOTO 280
270 END
280 CALL IOOUTPUTS(ADDR,SS,L) 'OUTPUT STRING
290 'TO BE SURE, TRIGGER COUNTER!
300 CALL IOTRIGGER(ADDR)
310 'GET THE MEASURING RESULT
320 MAX=25
330 ACT=0
340 RESS=SPACES(25)
350 CALL IOENTERS(ADDR,RESS,MAX,ACT)
360 PRINT
370 PRINT "RESULT READ AS: ";RESS
380 PRINT
390 GOTO 210

```

Example of a result:

```

INPUT YOUR PROGRAMMING MESSAGE?
(TO QUIT THE PROGRAM, ANSWER *)
PER A,MTIME 0
RESULT READ AS: PER 0000001.00E-5

```

```

INPUT YOUR PROGRAMMING MESSAGE?
(TO QUIT THE PROGRAM, ANSWER *)

```

For IBM PC with IBM GPIB

This example runs on an IBM PC with an 'IBM General Purpose Interface Bus Adapter' instead of the PM 2201 interface.

The following set of device parameters is suitable for a CNT-66 with address 10. The device parameters are set with the configuration program 'IBCONF', see the IBM adapter manual.

Device Name: COUNTER		DEVICE PARAMETERS		Number: D 0
DESCRIPTION	NEW VALUE	VALID NAME		
Access Adapter Name?	GPIB0	± [GPIBx]		
Primary GPIB Address?	00H	[0H to 1EH]		
Secondary GPIB Address?	00H	[60H to 7EH; 0H disables]		
Timeout setting?	T10s	± [T10us to T1000s; TNONE disables]		
EOS Byte?	00H	[0H to FFH or '<character>']		
Terminate Read on EOS?	Yes	± [Yes or No]		
Send EOI with EOS byte?	No	± [Yes or No]		
Use 8-bit Compare on EOS?	No	± [Yes or No]		
Send EOI w/last Byte of Write?	Yes	± [Yes or No]		

Example 1

The following program sets up the counter for 10 Period A measurements and presents the average result on the screen.

```

100 'DEMO PROGRAM
110 'CNT-66 AND IBM PC WITH IBM
120 'GPIB ADAPTOR AS CONTROLLER
130 CLS 'CLEAR SCREEN
140 'INIT
150 ADNAME$ = "COUNTER"
160 CALL IBFIND(ADNAME$,CNT%)
170 'SEND SDC
180 CALL IBCLR(CNT%)
190 'SELECT PERIOD A, TRIGGERED MODE
200 'AND MEASURING TIME 1 S
210 WRT$ = "PER A,TRIG ON,MTIME 1"
220 CALL IBWRT (CNT%,WRT$)
230 'INPUT 10 SAMPLES
240 Z=0
250 FOR I= 1 TO 10
260 CALL IBTRG(CNT%) 'TRIGGER COUNTER
270 CALL IBRD(CNT%,RD$) 'READ RESULT STRING
280 Z = Z + VAL (MID$(RD$,8,13))
290 NEXT I
300 PRINT "AVERAGE: ";Z/10;"S"
310 CALL IBLOC(CNT%) 'GO TO LOCAL
320 END

```

.Example of a result:

```

AVERAGE: 9.980422E-06 S
Ok

```

Chapter 6

Performance Check

Performance Check

Performance check describes the measuring methods and data necessary to verify correct signal values and voltage levels in the counter. After completed "Performance Check" the counter will meet the specifications published in this manual.

Preparations

Power up the instrument at least 30 minutes before checking to let it attain normal operating temperature.

■ Equipment Required

Type	Specifications
Adapter	BNC - banana
Adjustable power supply	4 V DC
Attenuator	BNC 20 dB
T-piece	BNC
Feedthrough termination	BNC 50 ohm /1W
Delay cable BNC-BNC	10 ns (about 2 m RG-58)
Digital multimeter	0-250 V AC, 0-10 V DC
Frequency reference	10 MHz, accuracy $3 \cdot 10^{-8}$
HF signal generator	1300 MHz
LF synthesizer	2 MHz
Oscilloscope	350 MHz
Pulse generator	1 μ s/250 ns
Adjustment tool	Insulated, for trimmer potentiometers & trimmer capacitors

Oscillator

To check the accuracy of the oscillator, use a reference with an accuracy of at least $3 \cdot 10^{-8}$. The Pendulum 6688 OCXO Frequency Reference meets this requirement, if calibrated and properly adjusted.

■ Uncompensated Crystal Oscillator

- Connect the external 10 MHz reference to input A.
- Select measuring time 1.0 s.
- The counter should display 10 MHz \pm 120 Hz. This is the maximum deviation after one year due to aging and temperature.

■ MTCXO Oscillator (Option 07)

- Connect the external 10 MHz reference to input A.
- Select measuring time 1.0 s.
- The counter should display 10 MHz \pm 6 Hz. This is the maximum deviation after one year due to aging and temperature.

Input A and B

Where the procedures for input A and input B are similar, only input A is described.

Frequency MHz	Sine wave mVpp (dBm)
1	56 (-21)
30	56 (-21)
80	113 (-15)
120	113 (-15)
160	170 (-11)

■ Sensitivity and Frequency Range

- Connect the HF generator (via an attenuator if required) to the BNC T-piece. Connect the T-piece to input A.
- Interconnect the T-piece with the 350 MHz oscilloscope. Use as short a cable as possible.
- Select measuring time 0.2 s.
- Select function FREQ A.
- Read the amplitude on the oscilloscope.
- The instrument shall count correctly with the following sine wave input signals:

■ Common via A

- Select RATIO A/B.
- Switch on COM.
- Connect the HF generator to input A.
- Set the generator frequency to 12 MHz and the signal amplitude to 70 mVpp (-19 dBm).
- The counter shall display 1.00000 \pm 1 in the last significant digit (LSD); the LSD and the trigger indicator for input B shall be visible.
- Turn off COM.

■ Sensitivity and Frequency Range in RATIO A/B

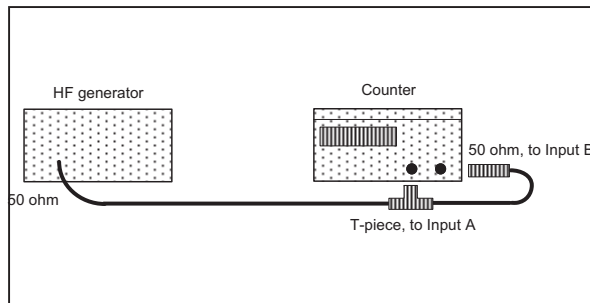

Figure 6-1 Measurement setup.

- Select RATIO A/B.
- Connect the HF generator via the BNC T-piece to input A.
- Connect the T-piece via a 50 ohm termination to input B.
- Set the generator frequency to 12 MHz sine wave, and the amplitude to 56 mVpp (-21 dBm).
- The instrument shall now count and display 1.00000 ± 1 in the LSD.

■ Trigger Level

- Connect the adjustable power supply and the multimeter to input A using the BNC banana adapter.
- Set the DC voltage to 4.00 V.
- Select DC, AUTO LEVEL, READ LEVEL and COMMON.
- The counter shall display “4.00 4.00”, ± 0.2 V.
- Move the DC voltage source to input B.
- Turn off COMMON.
- The counter shall display “0.00 4.00”, ± 0.2 V.

■ Voltage Measurement

- Disconnect all signal sources from both inputs.
- Press RESET and select VOLT A.
- Connect the LF synthesizer to input A.
- Set the synthesizer to sine wave with an amplitude of 9.8 Vpp.
- The counter shall display $4.9 \text{ V} \pm 0.2 \text{ V}$ and $-4.9 \text{ V} \pm 0.2 \text{ V}$ at the following frequencies: 1 kHz, 10 kHz, 500 kHz, and 2 MHz.

■ Single Time Interval A-B

- Connect the pulse generator to input A and input B.
- Set the generator signal repetition time to 1 μs and the amplitude to 2 Vpp.
- Set the rise and fall time to min.
- Select TIME A-B and negative SLOPE B.
- Select SINGLE measuring time.

- Set TRIGGER LEVEL to 1.00 V for both inputs.
- Adjust the duration time from the pulse generator to give a value of 0.1 μs on the counter display.
- Select negative SLOPE A and positive SLOPE B.
- The counter shall display 0.9 μs , ± 1 in the last digit.

■ Average Time Interval A-B

- Connect the Pulse Generator via the T-piece to input A.
- Connect the T-piece via a 50 ohm termination and a 10 ns coaxial cable to input B.
- Set the pulse repetition time to 50 μs .
- Set the signal amplitude to 2 Vpp.
- Set the pulse duration to 250 ns.
- Set the rise and fall time to min.
- Select positive SLOPE A and SLOPE B.

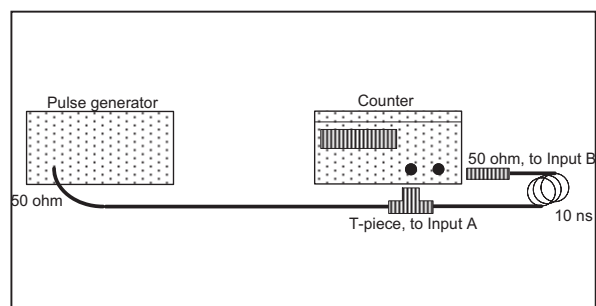

Figure 6-2 Measurement setup for average time interval A-B.

- Select 0.2 s measuring time.
- Select TIME A-B.
- Select AC on both inputs.
- Set SENSITIVITY to 0.02 V on both inputs.
- The counter shall display 10 ns ± 4 ns.
- Select negative SLOPE A and SLOPE B. The counter readout shall not change by more than 2 ns.
- Select positive SLOPE A and SLOPE B.

■ EXT REF Sensitivity

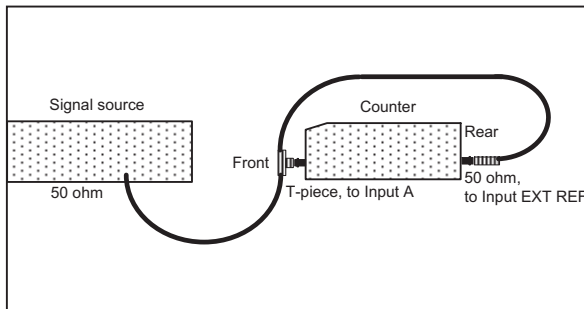

Figure 6-3 Measurement setup for EXT REF sensitivity.

- Disconnect all signal sources from both inputs.
- Select positive SLOPE A and SLOPE B.
- Select FREQ A.
- Fit a BNC T-piece to input A, and a 50 ohm termination to the EXT REF input.
- Connect a cable to the T-piece, and apply a 10 MHz ±0.1 MHz, 1.4 Vpp (7 dBm) sine wave signal.
- Make sure that the EXT REF and TRIGGER A indicators are visible.
- The instrument shall now count and display 10 MHz.

HF Input

Let the HF Input be in use for at least 10 minutes before checking it.

■ Sensitivity

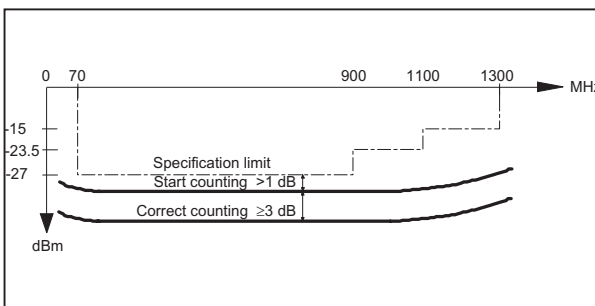

Figure 6-4 HF Input - sensitivity and counting levels.

- Connect the sweep generator to the HF input.
- Set the generator frequency to 70 MHz.
- Decrease the amplitude from the generator until the instrument stops counting.
- Increase the amplitude slowly until the instrument starts counting again. Read the value.

NOTE: Compensate for the losses in the coaxial cable when reading the value (about 1 dB/m for RG/M58).

- The “start counting” level shall be more than 1 dB below the specified limit shown in the figure.
- Repeat this procedure with the following frequencies:
- 100, 200, ... up to 1300 MHz

GPIB Interface (Option 04)

Type on the controller	This should happen
REMOTE 710	The remote indicator should be switched on.
OUTPUT 710;"ID?"	Ask for the counter identity.
ENTER 710;A\$	Input result from the counter.
DISP A\$	The response on the display of the controller is the identity of the counter.

Figure 6-5 GPIB command sequence

The test is intended for an HP-85 controller.

- Make sure that the TALK ONLY switch (the leftmost switch in the address switch block) is set to “0”.
- Address the counter and execute the command sequence in the table below.

The counter will, if everything is correct, identify itself as:

PM6666/YZW/MN

where

Y= 4 if the counter has an HF Input, else 0.

Z= 3 for MTCXO, else 1.

W= 6 (GPIB-bus is installed).

M= Revision No. of counter firmware.

N= Revision No. of GPIB-bus firmware.

Calibration and Adjustment

Calibration

To maintain the performance of the timer/counter, we recommend that you calibrate the timebase of your instrument every year, or more often if you require greater timebase accuracy. Calibration should be performed with traceable references and instruments at a certified calibration laboratory. Contact your local service center for calibration.

To know the present status of your instrument, test your counter from time to time. The test can be made according to the information in Chapter 6, "Performance Check".

Oscillators

The frequency of the reference crystal oscillator is the main parameter that influences accuracy of a counter. External conditions, such as ambient temperature and supply voltage, influence the frequency, but aging is also a factor. When adjusting, you compensate the reference crystal oscillator only for deviation in frequency due to aging.

■ Some Important Points:

The high-stability oscillator option 07 uses mathematical compensation of the displayed result, based on measured actual ambient temperature. Each MTCXO has a stored table of frequency deviations per degree C. The actual oscillator frequency varies with temperature, but the deviations are known and compensated for.

- The frequency uncertainty for standard oscillators is mainly dependent on the ambient temperature. Variations in ambient temperature between 0 and 50 °C may cause a frequency change of up to 100 Hz, whereas the aging per month is only 5 Hz. When operating, there is always a temperature increase inside the counter that will influence the oscillator.

How often should you calibrate?

In the table below you can see the uncertainty of your time base oscillator for various MTBRC (Mean Time Between Recalibration) intervals.

Compare the requirements of your application with the values in the table, and select the proper MTBRC accordingly.

Please note that the frequency uncertainty when operating in a temperature controlled environment is different from field use. See the two sections in the table.



When adjusted, keep in mind that the reference crystal oscillator will be compensated only for frequency deviation caused by aging.

Option Timebase type	Standard UCXO	Option 07 MTCXO
Total uncertainty , for operating temperature 0°C to 50°C, @ 2σ (95 %) confidence interval:		
-1 month after calibration	<1.2 x 10 ⁻⁵	<3 x 10 ⁻⁷
-3 months after calibration	<1.2 x 10 ⁻⁵	<4 x 10 ⁻⁷
-1 year after calibration	<1.2 x 10 ⁻⁵	<6 x 10 ⁻⁷
-2 years after calibration	<1.5 x 10 ⁻⁵	<1 x 10 ⁻⁶
Typical total uncertainty , for operating temperature 20°C to 26°C, @ 2σ (95 %) confidence interval:		
-1 month after calibration	<4 x 10 ⁻⁶	<2 x 10 ⁻⁷
-3 months after calibration	<4 x 10 ⁻⁶	<4 x 10 ⁻⁷
-1 year after calibration	<7 x 10 ⁻⁶	<6 x 10 ⁻⁷
-2 years after calibration	<1.2 x 10 ⁻⁵	<1 x 10 ⁻⁶

For complete specifications see chapter 9 (Specifications)

Timebase References

This chapter describes adjustment procedures which may need to be performed occasionally, and which must be performed after repair.

Removing the Cover

WARNING: When you remove the cover you will expose live parts and accessible terminals which can be dangerous to life.

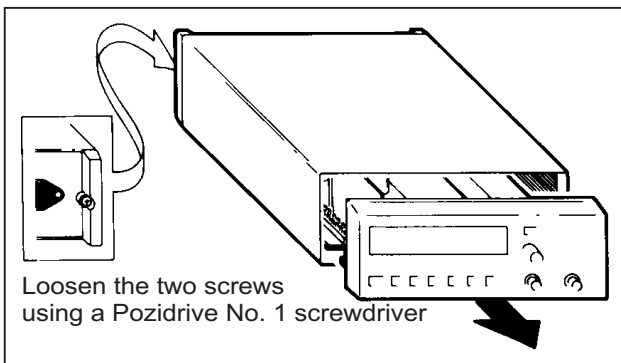

Figure 7-1 Loosen These Screws to Remove Cover.

- Make sure that the power cable is disconnected.

WARNING: Although the power switch is in the off position, the line voltage is present on the printed circuit board.

- Loosen the two screws in the rear feet.
- Grip around the front panel and gently pull the Timer/Counter out of the cover.

Equipment

For required test equipment, see Performance Check.

■ Frequency Reference

The Pendulum 6688 frequency standard or the option 40 oven-enclosed oscillator available in some Pendulum counters meet the requirement, if calibrated within the last 12 months.

Checking Accuracy

■ Uncompensated Crystal Oscillator

- Power up the instrument at least 30 minutes before checking to let it attain normal operating temperature.
- Connect the external 10 MHz reference to input A.

- Set the oscillator frequency to 10 MHz \pm 10 Hz by adjusting the trimmer capacitor C403 from the solder side of the oscillator board. Use the specified screwdriver.

■ MTCXO (Option 07)

The optional MTCXO Time-base can easily be calibrated and adjusted without using tools.

Preparations

If you remove the cover when the counter has been switched on, the temperature of the MTCXO will rapidly drop about 10°C. Since the MTCXO must have a stable temperature when calibrating you must wait an hour between removing the cover and calibrating.

If the counter has been switched off more than three hours, you can calibrate it directly.

Calibration and Adjustment Procedure

- Remove the cover see preceding paragraph.
- Allow the MTCXO to reach the new ambient temperature. (See 'Preparations'.)
- Connect the 10 MHz reference to Input-A.
- Switch ON the counter.
- Adjust the sensitivity control so that the counter counts properly.
- Hold down the CALIB-button, on the main printed-circuit board in the counter, and press the Reset-button.

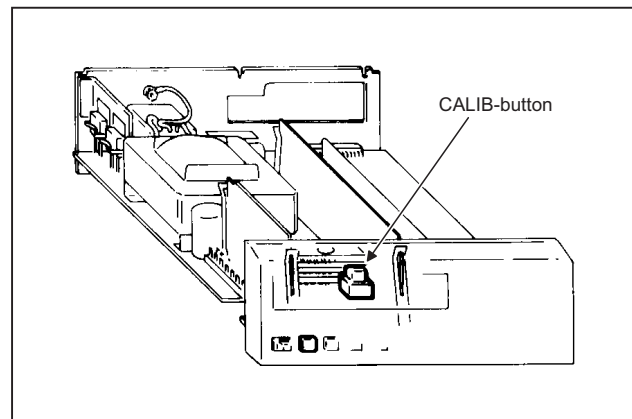

Figure 7-2 Location of the CALIB-Button

- Wait about 20 seconds, until the display shows 10.0000000 MHz. Now the oscillator is calibrated.
- Switch OFF the counter and disconnect the 10 MHz reference.
- Fit the cover.

The MTCXO is now adjusted to a relative uncertainty of

$$2 \times \sqrt{\frac{U_r^2 + U_c^2}{3}}$$

where

U_r = resolution uncertainty = 2×10^{-8}

U_c = relative uncertainty of calibration.

This page is intentionally left blank.

Chapter 8

Specifications

Measuring Functions

Frequency A or C

(frequency B via GPIB/IEEE-488 only)

■ Range

- Freq A:** 0. 1 Hz to 160 MHz (1 20 MHz to 160 MHz with limited temperature range; typical +23°C ±5°C)
- Freq B:** 0. 1 Hz to 16 MHz (via GPIB/ IEEE-488 only)
- Freq C:** 70 MHz to 1.3 GHz
- Mode:** Reciprocal frequency counting

LSD Displayed: $\frac{2.5 \times 10^{-7} \times FREQ}{measuring\ time}$

Period A

- Range:** 8 ns to 2*10⁸s
- Mode:** Single period measurement (SINGLE) or average period measurement (at 0.2s, 1s or 10s measuring times)

LSD Displayed: SINGLE period measurement:

$$\frac{100\ ns}{10^9\ s} \quad (Time < 100s)$$

$$\frac{5 \times PERIOD}{10^9\ s} \quad (Time > 100s)$$

Average period measurement:

$$\frac{2.5 \times 10^{-7} \times PERIOD}{measuring\ time}$$

Ratio A/B

(ratio B/A, C/A or C/B via GPIB/IEEE-488 only)

- Range:** 1*10⁻⁷ to 2*10⁹ (A/B); 1*10⁻⁸ to 2*10⁸ (B/A); 0 to 1*10¹⁵ (A/B SINGLE and B/A SINGLE); 8 to 6*10¹⁰ (C/A, C/B)

Frequency Range

- Input A:** 0 MHz to 160 MHz (A/B); 0 MHz to 16 MHz (B/A, C/A, A/B SINGLE) (120 MHz to 160 MHz with limited temperature range; typical +23°C ±5°C)
- Input B:** 0 MHz to 16 MHz
- Input C:** 70 MHz to 1.3 GHz

LSD Displayed (Ratio A/B)

$$\frac{25}{meas\ time \times FREQ\ B}$$

(0.2, 1, or 10 s measuring times)

LSD Displayed (Ratio B/A):

$$\frac{2.5}{meas\ time \times FREQ\ B}$$

(0.2, 1, or 10 s measuring time)

LSD Displayed (Ratio A/B Single, and Ratio B/A Single):

$$\frac{1}{10^9} \quad RATIO < 10^9$$

$$\frac{5 \times RATIO}{10^9} \quad RATIO > 10^9$$

LSD Displayed (Ratio C/A or C/B):

$$\frac{640}{meas\ time \times FREQ\ A\ or\ B}$$

Time Interval A/B

(time interval B-A via GPIB/IEEE-488 only)

- Range:** 100 ns to 2*10⁸s (SINGLE); 0 ns to 20s (average)
- Mode:** Single time interval (SINGLE) for time interval measurements (at 0.2s, 1s or 10s measuring times)

LSD Displayed: SINGLE time interval measurement:

$$\frac{100\ ns}{10^9\ s} \quad (Time < 100s)$$

$$\frac{5 \times TIME}{10^9\ s} \quad (Time > 100s)$$

Average time interval measurements:

$$\frac{2.5 \times 10^{-7} s}{N}$$

Averaged Number of Intervals N: measuring time/pulse repetition time

Note: Input signals must be repetitive and asynchronous with respect to the time base

Min Dead Time from Stop to Start: 250 ns

Timing Difference A-B Channels: 4 ns max

Totalize A

(totalize B via GPIB/ IEEE-488 only)

Range: 0 to 1*10¹⁵ with indication of k or M (kilopulses or Megapulses) the result is truncated if out of display range

Frequency Range: 0 Hz to 12 MHz

Pulse Pair Resolution: 80 ns

LSD Displayed: 1 unit count (counts <10⁹); 5*counts/10⁹ (counts ≥10⁹)

Gated by B (A) Mode: Event counting on input A (B) during the duration of a pulse on input B (A)

Start/Stop by B (A) Mode: Event counting on input A (B) between two consecutive pulses on input B (A)

Manual Mode: Event counting is controlled by the START/STOP button. Sequential start-stop counts are accumulated. RESET closes the gate and resets the timer/counter to zero.

Attenuation: to 60 mVrms typ., 120 MHz to 160 MHz (at room temp.)
x1 or x10, switch selectable or AUTO

Trigger Slopes: Positive or negative

Volt Max/Min A

(Volt max/min B via GPIB/IEEE-488 only)

Range: –51V to +51V
Frequency Range: DC and 100 Hz to 50 MHz (input A); dc and 100 Hz to 5 MHz (input B)
Resolution: Input signals within $\pm 5V$, 20 mV; input signals outside $\pm 5V$, 200 mV

Uncertainty
DC and 100 Hz to 12 MHz (A), or to 1MHz (B):
Input signals within $\pm 5V$, 30 mV $\pm 1\%$ of reading $\pm 3\%$ of Vp-p; input signals outside $\pm 5V$, 300 mV $\pm 3\%$ of reading $\pm 3\%$ of Vp-p
Uncertainty 12 MHz to 50 MHz (A) or 1MHz to 5 MHz (B):
Input signals within $\pm 5V$, 30 mV $\pm 10\%$ of reading $\pm 10\%$ of Vp-p; input signals outside $\pm 5V$, 300 mV $\pm 10\%$ of reacting $\pm 10\%$ of Vp-p

Input-A and Input-B

Frequency Range
DC-Coupled: DC to 160 MHz (120 MHz to 160 MHz with limited temperature range; typical $+23^{\circ}C \pm 5^{\circ}C$)
AC-Coupled: 20 Hz to 160 MHz (120 MHz to 160 MHz with limited temperature range; typical $+23^{\circ}C \pm 5^{\circ}C$)
Minimum Pulse Duration: 4 ns
Coupling: AC or DC
Impedance: $1M\Omega/35\text{ pF}$
Channel Input: Separate A and B, or common via A
Maximum Voltage Without Damage: 350V (dc + ac peak) between 0Hz and 440 Hz, falling to 8V rms at 1MHz

Sensitivity, DC-Coupled
Sine: 20 mVrms, 0Hz to 30 MHz; 40 mVrms, 30 MHz to 120 MHz, 60 mVrms typ., 120 MHz to 160 MHz (at room temp.)
Pulse: 60 mVp-p, 0Hz to 30 MHz; 110 mVp-p, 30 Hz to 120 MHz; sensitivity decreases to 60 mVrms at 160 MHz typically

Sensitivity, AC-Coupled
Sensitivity is selectable in 6 steps: 20 mV, 50 mV, 100 mV, 200 mV, 500 mV and 1Vrms (sine) nominal
Maximum Sensitivity: 20 mVrms, 20 Hz to 30 MHz; 40 mVrms, 30 MHz to 120 MHz; sensitivity decreases

Trigger Level Range
DC-Coupled: –51V to +51V, adjustable via up/down control
AC-Coupled: 0V fixed or AUTO level
Trigger Level Resolution: 20 mV, signals within $\pm 5V$; 200 mV, signals outside $\pm 5V$
Trigger Level Setting Accuracy: $\pm 10mV \pm 1\%$ of setting

AUTO Trigger Level: Trigger Level on input A (and B when required) is automatically set to 50% of input signal amplitude.
Frequency Range: 100 Hz to 160 MHz (120 MHz to 160 MHz with limited temperature range; typical $+23^{\circ}C \pm 5^{\circ}C$)
Sensitivity: 150 mVpp
Trigger Indicators: Tri-state LED indicators;
On: Signal above set trigger level.
Off: Signal below set trigger level.
Blinking: Triggering occurs.

Input Channel Selection: Separate A and B, or A and B common via input-A.

Input C

Frequency Range: 70 MHz to 1.3 GHz
Coupling: AC
Operating Input Voltage Range: 10 mVrms to 12Vrms, 70 MHz to 900 MHz; 15 mVrms to 12Vrms, 900 MHz to 1100 MHz; 40 mVrms to 12Vrms, 1100 MHz to 1300 MHz
AM Tolerance: 94% at max 100 kHz modulation frequency; minimum signal must exceed minimum operating input voltage requirement
Input Impedance: 50Ω nominal, VSWR :1
Max Voltage Without Damage: 12V rms, overload protection with pin diodes

External Reference Input D

Input Frequency: 10 MHz ± 0.1 MHz
Coupling: AC
Sensitivity: 500 mV rms
Input Impedance: Approx 300Ω at 10 MHz
Maximum Input Voltage: 15Vrms

Auxiliary Functions

■ Power On/Off

Switches counter power on/off. At power up a self-test is made and the counter is set to default settings.

■ Default Settings

Function: FREQ A
Measuring-Time: 0.2 s
Coupling: AC on Input-A, DC on Input-B
Trigger level: Auto
Trigger slope: Positive on A and B.

RESET

The RESET button has three functions:

RESET: Starts a new measurement. The settings are not changed.
LOCAL: Makes the counter go to LOCAL operation, when in remote operation (unless Local Lock-Out is programmed).
START/STOP: Opens/closes the gate in TOTALIZE A, manual mode.

Measuring Time

A measuring time of 0.2s, 1s, 10s or SINGLE can be selected

NOTE: When SINGLE is selected together with PERIOD, RATIO or TIME, the result is a single cycle measurement, but SINGLE together with FREQUENCY results in a fixed 3 ms Measuring-time.

Measuring rate: Approx. 5 measurements/s. Approx. 2 measurements/s when AUTO trigger level is switched on.

Display time: Normally the display time equals the set Measuring-time. When SINGLE is selected, a display time of 0.1 seconds is used.

Display Hold

The current measuring result is frozen on the display. A new measurement starts when the RESET button is pressed.

Definitions

LSD Displayed

LSD = unit value of the least significant digit displayed. All calculated LSDs (see Measuring Functions section) should be rounded to the nearest decade (e.g., 0.3 Hz is rounded to 0.1 Hz and 5 Hz to 10 Hz) and cannot exceed the 9th digit.

Resolution

Resolution = smallest increment between two measuring results on the display, due to the ±1 count uncertainty.

Freq A, Freq C, Period A

Resolution can be 1 LSD or 2 LSD if:

$$\frac{LSD \times measuring\ time}{FREQ\ or\ PERIOD} < 10^{-7}$$

the resolution is 2 LSD units (30% probability). Otherwise resolution is 1 LSD unit (70% probability).

Ratio A/B:

Resolution can be 1 LSD or 2 LSD. If:

$$\frac{LSD \times measuring\ time}{RATIO} < \frac{10}{FREQ\ A}$$

the resolution is 2 LSD units (30% probability). Otherwise resolution is 1 LSD unit (70% probability).

SINGLE Period A and SINGLE Ratio A/B:

Resolution equals 1 LSD unit

Time A-B:

Resolution (95% confidence level) equals 1 LSD unit or 100 ns/√N, whichever is greater

Total uncertainty

The relative total uncertainty, depends on the following factors:

$$\frac{resolution}{FREQ, PERIOD, RATIO\ or\ TIME} = U_r$$

$$relative\ trigger\ uncertainty = U_n$$

$$relative\ timebase\ uncertainty = U_{tb}$$

$$relative\ systematic\ uncertainty = U_s$$

The total uncertainty (K=2) is calculated as:

$$2 \times \sqrt{\frac{U_r^2 + U_n^2 + U_s^2}{3} + U_{tb}^2}$$

Relative Trigger Uncertainty

■ Freq A, Period A:

$$\pm \frac{\text{noise voltage } A(Vp - p)}{\text{signal slope } A(V/s) \times \text{meas time}}$$

■ Ratio A/B:

$$\pm \frac{\text{noise voltage } B(Vp - p)}{\text{signal slope } B(V/s) \times \text{meas time}}$$

■ Totalize A, Gated or Start/Stop by B:

$$\pm \frac{\text{noise voltage } B(Vp - p)}{\text{signal slope } B(V/s) \times \text{gate time } B}$$

■ Time A-B:

$$\pm \frac{\text{noise voltage } A(Vp - p)}{\text{signal slope } A(V/s) \times \text{TIME} \times \sqrt{N}}$$

$$\pm \frac{\text{noise voltage } B(Vp - p)}{\text{signal slope } B(V/s) \times \text{TIME} \times \sqrt{N}}$$

■ Relative Time Base Uncertainty:

$$\pm \frac{\text{deviation from } 10 \text{ MHz}}{10 \text{ MHz}}$$

The relative time base uncertainty U_{tb} depends on the following factors:

U_i = initial uncertainty

U_t = freq. Uncertainty due to temperature variation

U_a = ageing

$$U_{tb} = \sqrt{\frac{U_i^2 + U_t^2 + U_a^2}{3}}$$

See table "Time Base".

■ Relative Time A-B Systematic Uncertainty:

Inaccuracy caused by timing difference between A and B channels $< \pm 4 \text{ ns/TIME}$

General Specifications

Power Requirements

Line Voltage: 115V or 230Vrms $\pm 15\%$; 45 Hz to 440 Hz; 20 VA CNT-66 including all options

Safety: Compliant to CE: EN 61010-1 (1990) + A1 (1992) Cat II

EMC: Compliant to CE: EN 55011 (1991) Group 1, Class B EN 50082-1 (1992)

Display

Readout: 9-digit LCD with unit and cursor indication

Unit Indication: MHz, kHz, Hz, mHz, ks, s, ms, μ s, ns, M, k, m, μ and n.

GATE Indicator: Indicates that the counter is measuring

REMOTE Indicator:

Indicates when the counter is remotely controlled via an installed GPIB/IEEE-488 interface (option 04)

Cursor:

Indicates selected measuring function, selected Measuring-time, input triggering, display hold and whether an external reference frequency is in use.

Time Base (Crystal oscillator)

	CNT-66	
	Standard	Option 07
Time base	Standard	Option 07
Time base type	UCXO	MTCXO
Uncertainty due to:		
- Calibration adj. Tolerance, at $+23^\circ\text{C} \pm 3^\circ\text{C}$	$<1 \times 10^{-6}$	$<1 \times 10^{-7}$
-Ageing: per 24h per month per year	n.a. $<5 \times 10^{-7}$ $<5 \times 10^{-6}$	n.a. $<1 \times 10^{-7}$ $<5 \times 10^{-7}$
- Temp. Variations: $0^\circ\text{C}-50^\circ\text{C}$, $20^\circ\text{C}-26^\circ\text{C}$ (typ. values)	$<1 \times 10^{-5}$ $<3 \times 10^{-6}$	$<2 \times 10^{-7}$ $<5 \times 10^{-8}$
- Power voltage variation: $\pm 10\%$	$<1 \times 10^{-8}$	$<1 \times 10^{-9}$
Power-on stability:		
- Deviations versus final value after 24hr on time, after warm-up time of:	n.a. 30 min	n.a. 30 min
Total uncertainty , for operating temperature 0°C to 50°C , at 2σ (95%) confidence interval:		
-1 year after calibration	$<1.2 \times 10^{-5}$	$<6 \times 10^{-7}$
-2 years after calibration	$<1.5 \times 10^{-5}$	$<1 \times 10^{-6}$
Typical total uncertainty , for operating temperature 20°C to 26°C , at 2σ (95%) confidence interval:		
-1 year after calibration	$<7 \times 10^{-6}$	$<6 \times 10^{-7}$
-2 years after calibration	$<1.2 \times 10^{-5}$	$<1 \times 10^{-6}$

Environmental Data

Temperature

Operating: 0°C to + 50°
Storage: -40°C to +70°

Altitude

Operating: 5000m (53.3 kN/m²)
Storage: 15,000m (15.2 kN/m²)

Humidity

Operating: 10% to 90% RH, no condensation
Storage: 5% to 95% RH

Vibration Test: According to IEC 68Fc

Bump Test: According to IEC 68Eb

Handling Test: According to IEC 68Ec

Mechanical Data

Size: 186 mm W * 88 mm H * 270 mm L (7.3 in W * 3.5 in H * 10.6 in L)

Weight: 2.1 kg (4.6 lb)

Optional Accessories

GPIB/IEEE-488 Interface, Option 04

Mounting: Inside counter cabinet

Interface Functions:

SH1, AH1, T5, L4, SR1, RL1, DC1, DT1, E2

Address Setting: Switch selectable at rear panel between 0 and 30. Factory preset at 10.

Programmable Device Functions:

- Measuring functions
- Measuring-time
- Trig level offset selection
- Trigger slope
- Manual Totalize gate control
- Output separator selection
- Device clear
- Device trigger
- High-speed dump
- MTCXO on/off
- Short output format
- Free run/Triggered measurements
- Set SRQ-mask
- Program data out queries
- Device identity query

Programming Code Format:

7-bit ISO code (ASCII) characters. Both upper and lower case characters are accepted.

Output Format

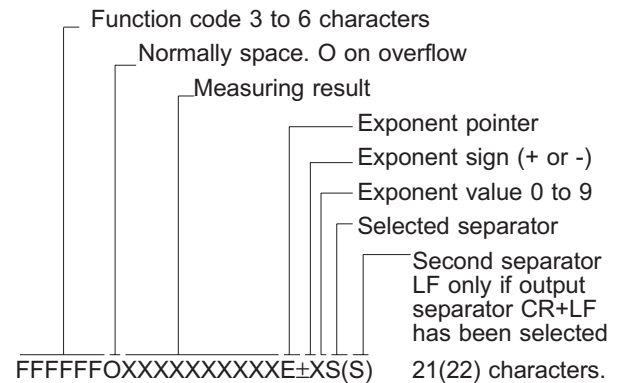

When you select 'Short output format' FFFFFFF and leading zeroes are omitted.

Output Data Separator:

Default separator at power-on is LF. The separator can be programmed to be any non printable ASCII-code with decimal equivalent 0-31, except 27 (ESC). In addition the combination 13+10 (CR+LF) can be programmed. The EOI-line can be programmed to be active together with the last output byte sent.

Input Separator: The counter accepts the following characters as separators: ETX, ETB, CR, LF, ' '(space)', ',' (comma), ':' (colon), ';' (semicolon).

High-Speed Dump:

The contents of the counting registers are transferred to the controller, without being processed by the counter. The processing must be done in the controller instead.

The output format is FMXXXXXXXXXXS(S) where F is calculation formula, M is multiplier, X..X = 12 hex-digits representing the register contents, and S(S) is the set output separator.

Ranges: Same as for normal operation, with the following exceptions:

- Frequency:** Max measuring time: 1 s
- Period, average:** Max measuring time: 1.4 s
- Time interval, average; 0 ns to 1.6 s:** Max measuring time: 4 s
- Ratio A/B: 0 and $6 \cdot 10^{-7}$ to $1.6 \cdot 10^8$
- Ratio B/A: 0 and $6 \cdot 10^{-8}$ to $1.6 \cdot 10^7$
- Ratio C/A, C/B: 8 to $4 \cdot 10^9$

Max Data Output Rate**Normal Mode:** Approx 5 readings/s**High-Speed Dump:**

Approx 100 readings/s. The highest output rate is obtained at SINGLE measuring time.

Output Time for Measuring Data**Normal Mode:** Approx 9 ms (20 bytes)**High-Speed Mode:**

Approx 4 ms (15 bytes)

Response Time for Addressing:Approx 600 μ s**Response Time for Trigger Command (GET):****Normal operation:** Approx. 10 ms**High-speed dump:** Approx. 2 ms**Response Time for Serial Poll:**

Approx. 1.5 ms

Input Buffer Size: 28 bytes**Typical Read Time for Programming Data:**

Approx 1ms/byte (unless input buffer is full)

Rack Mounting Adapter, Option 06

The option 06 is a 19" wide Rack Mounting Adapter. It can host one CNT-66 or CNT-69 Counter only.

High stability time-base, Option 07

See specifications for optional MTCXO time-base.

Carrying Case, Option 09

The option 09 is a leather-like carrying case, for protection of the counter during transportation.

Ordering Information

Models

CNT-66 Timer/Counter

Included with the Instrument

Line cord, operator manual, and Calibration certificate.

Reference Oscillator Option

Option 07 MTCXO Timebase

Interface Option

Option 04 GPIB/IEEE-488

Optional Accessories

Option 06 Rack mount kit

Option 09 Carrying case

This page is intentionally left blank.

Chapter 9

Appendix

Checking the Sensitivity of Counters

Introduction

The sensitivity of a counter is normally specified as the minimum signal voltage on which the input of the counter will trigger correctly.

When you use a signal-source with an output-impedance of 50Ω , constant-output-amplitude, and the counter has a 50Ω input-impedance, the input signal of the counter is in theory independent of the cable length. However, if the input impedance deviates from 50Ω there will be standing wave reflections which will cause changes in the amplitude of the signal between the signal-source and the counter input.

Two factors determine the magnitude of the changes, i.e. frequency and capacitive load.

EXAMPLE: For a $1\text{ M}\Omega/35\text{ pF}$ input, the 35 pF parallel capacitance is approximately equal to a 50Ω capacitive load at 100 MHz .

Consequently, it is of the utmost importance to know how sensitivity is measured.

Recommended Instruments

- Signal-source with a 50Ω output impedance.
- $>350\text{ MHz}$ oscilloscope with a 50Ω input impedance.
- BNC T-piece.
- Two BNC-cables, one short and one long.

■ High Impedance Inputs ($1\text{ M}\Omega$)

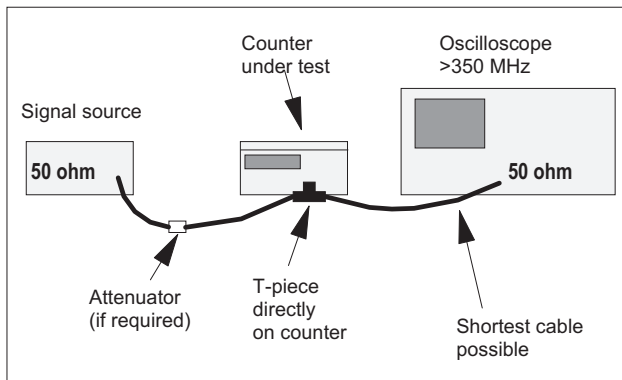

Figure 9-1 GPIB connector and address switch, the numbers above the switches indicate the significance of each switch.

Preparations

Connect the instruments as illustrated in the figure above. Turn off AUTO and set the counter to maximum sensitivity.

Method 1

- Adjust the amplitude of the signal-source to the minimum level accepted by the counter.
- Read the amplitude on the oscilloscope.
- Check that the reading is the same as, or less than, the sensitivity level in the counter specifications.

Method 2

- Adjust the amplitude of the signal-source until the oscilloscope indicates the sensitivity limit in the counter specifications.
- Check that the counter is operating correctly.

■ Low Impedance Inputs (50Ω)

If You Have a Calibrated Signal Source

- Adjust the signal-source to the sensitivity limit of the counter.
- Connect it directly to the input of the counter.
- Check that the counter is operating correctly.

If You Don't Have a Calibrated Signal Source

Use either of the following methods

Method 1

- Connect the output of the signal-source directly to the input of the counter.
- Turn off AUTO and Set the counter to maximum sensitivity (if adjustable).
- Adjust the amplitude of the signal-source to the minimum level accepted by the counter.
- Disconnect the cable from the counter and connect it to the oscilloscope.
- Read the amplitude on the oscilloscope.
- Check that the reading is the same as, or less than, the sensitivity level in the counter specifications.

Method 2

- Connect the signal-source to the oscilloscope.
- Adjust the output amplitude of the signal-source until the oscilloscope indicates the sensitivity limit in the counter specifications.
- Disconnect the cable from the oscilloscope and connect it to the counter.
- Turn off AUTO and set the counter to maximum sensitivity (if adjustable).
- Check that the counter is operating correctly.

These procedures ensure unambiguous measurements of the signal voltage at the input of the counter.

Chapter 10

Service

Sales and Service office

For additional product information, customer support and service, please contact Pendulum Instruments AB at the following address:

Pendulum Instruments AB

Box 20020

SE-161 02 Bromma

Sweden

Visit address:

Karlsbodavägen 39, Bromma

Phone: +46 (0)8 5985 1000

Fax: +46 (0)8 5985 1040

Email: info@pendulum.se

Web Site: www.pendulum.se

This page is intentionally left blank.

Chapter 11

Index

Index

A

- Abnormal bit
 - SEE* Status byte
- AC
 - Selecting. 4-10
- AC coupling selection buttons.
 - Location 2-3
- Address 5-3
- Adjustments
 - timebase. 7-2
- Attenuator
 - From GPIB 5-6
 - Operating 4-10
 - x1 4-10
 - x10 4-10
- Attenuator buttons
 - Location 2-3
- Auto level button
 - Location 2-3
- Auto On/Off
 - GPIB code 4-10
 - Selection. 4-10

B

- Bus commands
 - Summary 5-12 - 5-13
- Bus drivers. 5-2
- Bus learn
 - GPIB. 5-11

C

- Calibration 7-2
- Caution statements 1-2
- Check list
 - GPIB program 5-4
- Checking
 - GPIB communication 5-3
- COM B via A button
 - Location 2-3
- Common
 - From GPIB 5-7
 - GPIB code 4-12
 - Operation 4-12
- Control function 5-2
- Controller
 - Connecting GPIB 5-3

- Controls
 - operation 4-2
- Coupling
 - From GPIB 5-6
 - GPIB code 4-10
 - Selecting. 4-10
- Cover removal 7-3
- Crystal oscillators
 - calibration. 7-2

D

- DC
 - Selecting. 4-10
- Delimiters
 - SEE* Separators
- Device clear 5-2
- Device Trigger 5-2
- Display hold
 - Operating the button. 4-8
- Display-hold button
 - Location 2-3

E

- Earthing
 - SEE* Grounding
- EOI mode
 - SEE* Output separator
- Error codes 4-3,4-14
- External reference
 - Connection 3-3
 - Description of function 4-13
 - Location of connector 2-2
- External reference input
 - Connection 4-12

F

- Free run
 - From GPIB 5-7
- Frequency A
 - From GPIB 5-5
 - GPIB code 4-2
- Frequency B
 - From GPIB 5-6
 - Selecting. 4-2

- Frequency C
 GPIB code 4-4
 Selecting. 4-4
- Function selection
 GPIB. 5-5
- Function-selector button
 Location 2-3
- ## G
- Get
 SEE Triggered
- GPIB address-selector
 Location 2-2
- GPIB interface-connector
 Location 2-2
- GPIB-Interface operation 5-1 - 5-16
- ## H
- High speed dump
 GPIB. 5-10
- Hold
 display 4-8
- HP controller
 GPIB example 5-14
- ## I
- IBM GPIB
 GPIB example 5-16
- ID?
 GPIB. 5-3
 Identity of the counter. 5-3
- Input separator
 GPIB. 5-4
- Input A 6-2
 Operation 4-8
- Input B 6-2
 Operation 4-8
- Input C
 Operation 4-12
- Input settings
 From GPIB 5-6
- Input-A BNC-connector
 Location 2-3
- Input-B BNC-connector
 Location 2-3
- Input-C BNC-connector
 Location 2-3
- ## L
- LCD-display
 Location 2-3
- Listener function. 5-2
- Local 4-8
- DC coupling selection buttons 2-3
- ## M
- Measuring
 Frequency A 4-2
 Frequency C 4-4
 Period 4-4
 Ratio A/B 4-4
 Time interval A-B 4-4
 Time selection 4-6
 Totalize 4-4
 Voltage 4-6
- Measuring time
 From GPIB 5-6
- Measuring-time selector-button
 Location 2-3
- MTCXO
 Calibration 7-3
- ## N
- Normal output format
 GPIB. 5-10
- ## O
- Operating the controls 4-2
- Oscillators
 calibration. 7-2
- Output separator
 GPIB. 5-5
- Output mode
 GPIB 5-9 - 5-10
- ## P
- Period
 From GPIB 5-5
- Period A
 Selecting. 4-4
- PM 2201
 GPIB example 5-15
- Power switch
 Operating 4-2
- Power switch
 Location 2-3
- Power-inlet socket
 Location of 2-2
- Programming check-list 5-4
- ## Q
- Queries
 GPIB. 5-12

R

Rack mount adapter	
installation	3-3
Rack Shelf	3-3
Ratio A/B	
GPIB code	4-4
Selecting	4-4
Read level	4-12
Read level	
GPIB code	4-12
Read level button	
Location	2-3
Rear feet	2-2
Remote/local	5-2
Removing the cover	7-3
Reset	
Description of function	4-9
Operating the button	4-8
Reset button	
Location	2-3
S	
Safety	1-2
Screws for removing the cover	2-2
Selecting function	
via GPIB	5-6
Sensitivity	
From GPIB	5-6
GPIB code	4-10
Separators	
Input	5-4
Output	5-5
Service request	5-2
GPIB	5-8
Set value	
Operation	4-10
Set value button	
Location	2-3
Short output format	
GPIB	5-10
Slope	
From GPIB	5-6
GPIB code	4-10
Operation	4-10
Slope selection buttons	
Location	2-3
Start/Stop Totalize	
Operation	4-8
Start/Stop totalize	
From GPIB	5-7

Starting a new measurement	
<i>SEE</i> Reset	
Status byte	
GPIB	5-8
Symbols	1-2
T	
Talk only switch	5-3
Talker function	5-2
Tilting support	2-3
Time interval A/B	
From GPIB	5-5
Time interval A-B	
GPIB code	4-4
Selecting	4-4
Time out	
GPIB	5-7
Timebase	
calibration	7-2
Totalize A	
From GPIB	5-5
GPIB code	4-4
Selecting	4-4
Trigger indicators	
Location	2-3
Trigger level	
From GPIB	5-7
GPIB code	4-10
Triggered mode	
From GPIB	5-7
U	
Unpacking	3-2
W	
Warning statements	1-2
V	
Volt max/min	
Selecting	4-6
Voltage-range	
Location of	2-2
Selecting	3-2