

pendulum



Timer/Counter/Analyzer

CNT-90, CNT-91

Frequency Calibrator/Analyzer

CNT-91R

Microwave Counter/Analyzer

CNT-90XL

User's Manual

4031 600 90001

2020- 22nd Edition

© 2020, Pendulum Instruments

//

Table of Contents

| | | | |
|--|------------|--|--|
| GENERAL INFORMATION | 1-VIII | | |
| About this Manual | 1-VIII | | |
| Warranty | 1-VIII | | |
| Declaration of Conformity..... | 1-VIII | | |
| 1 Preparation for Use | | | |
| Preface..... | 1-2 | | |
| Introduction | 1-2 | | |
| Powerful and Versatile Functions | 1-2 | | |
| No Mistakes | 1-3 | | |
| Design Innovations..... | 1-3 | | |
| State of the Art Technology Gives | | | |
| Durable Use..... | 1-3 | | |
| High Resolution..... | 1-3 | | |
| Remote Control | 1-4 | | |
| Fast GPIB Bus | 1-4 | | |
| Safety..... | 1-5 | | |
| Introduction | 1-5 | | |
| Safety Precautions | 1-5 | | |
| Caution and Warning Statements..... | 1-6 | | |
| Symbols..... | 1-6 | | |
| If in Doubt about Safety..... | 1-6 | | |
| Disposal of Hazardous Materials..... | 1-6 | | |
| Environmental Considerations..... | 1-6 | | |
| Unpacking | 1-7 | | |
| Check List | 1-7 | | |
| Identification..... | 1-7 | | |
| Installation..... | 1-8 | | |
| Supply Voltage..... | 1-8 | | |
| Battery Supply..... | 1-8 | | |
| Grounding | 1-8 | | |
| Orientation and Cooling | 1-8 | | |
| Fold-Down Support | 1-9 | | |
| Rackmount Adapter | 1-9 | | |
| 2 Using the Controls | | | |
| Basic Controls | 2-2 | | |
| Secondary Controls..... | 2-4 | | |
| Connectors & Indicators | 2-4 | | |
| Rear Panel..... | 2-5 | | |
| Rear Panel (CNT-91R/71B)..... | 2-6 | | |
| Description of Keys | 2-7 | | |
| Power | 2-7 | | |
| Select Function | 2-7 | | |
| Autoset/Preset | 2-8 | | |
| Move Cursor | 2-8 | | |
| Display Contrast..... | 2-8 | | |
| Enter | 2-8 | | |
| Save & Exit | 2-8 | | |
| Don't Save & Exit..... | 2-8 | | |
| Presentation Modes..... | 2-9 | | |
| Entering Numeric Values | 2-10 | | |
| Hard Menu Keys..... | 2-10 | | |
| Default Settings | 2-19 | | |
| 3 Input Signal Conditioning | | | |
| Input Amplifier..... | 3-2 | | |
| Impedance | 3-2 | | |
| Attenuation | 3-2 | | |
| Coupling | 3-3 | | |
| Filter..... | 3-3 | | |
| Man/Auto..... | 3-4 | | |
| Trig..... | 3-5 | | |
| How to Reduce or Ignore Noise and | | | |
| Interference | 3-6 | | |
| Trigger Hysteresis | 3-6 | | |
| How to use Trigger Level Setting | 3-7 | | |
| 4 Measuring Functions | | | |
| Introduction to This Chapter..... | 4-2 | | |
| Selecting Function | 4-2 | | |
| Frequency Measurements | 4-3 | | |
| FREQ A, B..... | 4-3 | | |
| FREQ C..... | 4-4 | | |
| CNT-90/91(R)..... | 4-4 | | |
| CNT-90XL | 4-4 | | |
| RATIO A/B, B/A, C/A, C/B | 4-4 | | |
| BURST A, B, C | 4-4 | | |
| 1-8 Triggering | 4-4 | | |
| Burst Measurements using Manual | | | |
| Presetting | 4-5 | | |
| Frequency Modulated Signals..... | 4-6 | | |
| Carrier Wave Frequency f_0 | 4-6 | | |
| f_{\max} | 4-7 | | |
| f_{\min} | 4-7 | | |
| Δf_{p-p} | 4-8 | | |
| Errors in f_{\max} , f_{\min} , and Δf_{p-p} | 4-8 | | |
| AM Signals | 4-8 | | |
| Carrier Wave Frequency..... | 4-8 | | |
| Modulating Frequency | 4-9 | | |
| Theory of Measurement | 4-9 | | |
| Reciprocal Counting | 4-9 | | |
| Sample-Hold..... | 4-10 | | |
| Time-Out | 4-10 | | |
| Measuring Speed | 4-10 | | |
| PERIOD | 4-13 | | |
| Single A, B & Avg. A, B, C | 4-13 | | |

| | |
|--|-------------|
| Single A, B Back-to-Back | 4-14 |
| Frequency A, B Back-to-Back | 4-14 |
| Time Measurements | 4-15 |
| Introduction | 4-15 |
| Triggering | 4-15 |
| Time Interval | 4-16 |
| Time Interval A to B | 4-16 |
| Time Interval B to A | 4-16 |
| Time Interval A to A, B to B | 4-16 |
| CNT-91(R): Time Interval Error (TIE) | 4-16 |
| Rise/Fall Time A/B | 4-16 |
| Pulse Width A/B | 4-17 |
| Duty Factor A/B | 4-17 |
| Measurement Errors | 4-18 |
| Hysteresis | 4-18 |
| Overdrive and Pulse Rounding | 4-18 |
| Auto Trigger | 4-19 |
| Phase | 4-20 |
| What is Phase? | 4-20 |
| Resolution | 4-20 |
| Possible Errors | 4-20 |
| Inaccuracies | 4-21 |
| Totalize [CNT-91(R) only] | 4-24 |
| Totalize in General | 4-24 |
| TOT A MAN | 4-24 |
| TOT B MAN | 4-24 |
| TOT A+B MAN | 4-24 |
| TOT A-B MAN | 4-25 |
| Applications | 4-25 |
| TOT A/B MAN | 4-25 |
| Totalize & Arming | 4-25 |
| Examples | 4-25 |
| Voltage | 4-27 |
| V_{MAX} , V_{MIN} , V_{PP} | 4-27 |
| V_{RMS} | 4-28 |
| Pulsed Signals | |
| [CNT-90XL option 28 only] | 4-29 |
| Frequency in Pulse | 4-30 |
| Selecting Pulsed RF Measurements | 4-30 |
| PRI | 4-31 |
| PRF | 4-32 |
| Pulse Width Pos | 4-32 |
| Pulse Width Neg | 4-32 |
| Duty Factor Pos | 4-32 |
| Duty Factor Neg | 4-32 |
| Power On | 4-32 |

5 Measurement Control

| | |
|---------------------------|-----|
| About This Chapter | 5-2 |
| Measurement Time | 5-2 |
| Gate Indicator | 5-2 |
| Single Measurements | 5-2 |
| Hold/Run & Restart | 5-2 |
| Arming | 5-2 |
| Start Arming | 5-3 |
| Stop Arming | 5-3 |

Controlling Measurement Timing... 5-4

| | |
|---|------|
| The Measurement Process | 5-4 |
| Resolution as Function of Measurement Time | 5-4 |
| Measurement Time and Rates | 5-5 |
| What is Arming? | 5-5 |
| Arming Setup Time | 5-9 |
| Arming Examples | 5-9 |
| Introduction to Arming Examples | 5-9 |
| #1 Measuring the First Burst Pulse | 5-9 |
| #2 Measuring the Second Burst Pulse | 5-11 |
| #3 Measuring the Time Between Burst Pulse #1 and #4 | 5-12 |
| #4 Profiling | 5-13 |

6 Process

| | |
|--|-----|
| Introduction | 6-2 |
| Averaging | 6-2 |
| Mathematics | 6-2 |
| Example: | 6-2 |
| Statistics | 6-3 |
| Allan Deviation vs. Standard Deviation | 6-3 |
| Selecting Sampling Parameters | 6-3 |
| Measuring Speed | 6-4 |
| Determining Long or Short Time Instability | 6-4 |
| Statistics and Mathematics | 6-5 |
| Confidence Limits | 6-5 |
| Jitter Measurements | 6-5 |
| Limits | 6-6 |
| Limit Behavior | 6-6 |
| Limit Mode | 6-6 |
| Limits and Graphics | 6-7 |

7 Performance Check

| | |
|----------------------------|-----|
| General Information | 7-2 |
| Preparations | 7-2 |
| Test Equipment | 7-2 |
| Front Panel Controls | 7-3 |
| Internal Self-Tests | 7-3 |
| Keyboard Test | 7-3 |

| | | | |
|---|------------|---|-------------|
| Short Form Specification Test..... | 7-5 | Input and Output Specifications..... | 8-6 |
| Sensitivity and Frequency Range | 7-5 | Inputs A and B | 8-6 |
| Voltage..... | 7-6 | Input C (Option 10)..... | 8-7 |
| Trigger Indicators vs. Trigger Levels... | 7-7 | Input C (Option 13)..... | 8-7 |
| Input Controls..... | 7-8 | Input C (Options 14 & 14B)..... | 8-8 |
| Reference Oscillators (not CNT-91R) . | 7-8 | Rear Panel Inputs & Outputs..... | 8-8 |
| Rubidium Oscillator (CNT-91R and | | Auxiliary Functions..... | 8-8 |
| CNT-91R/71B) | 7-8 | Trigger Hold-Off..... | 8-8 |
| Resolution Test | 7-9 | External Start/Stop Arming..... | 8-8 |
| Rear Inputs/Outputs..... | 7-9 | Statistics..... | 8-8 |
| 10 MHz OUT (all models) 0.1, 1, 5 & 10 | | Mathematics | 8-9 |
| MHz OUT(CNT-91R/71B | | Other Functions | 8-9 |
| EXT REF FREQ INPUT | 7-9 | Display..... | 8-9 |
| EXT ARM INPUT..... | 7-10 | GPIB Interface | 8-9 |
| Measuring Functions | 7-10 | USB Interface..... | 8-10 |
| Check of HOLD OFF Function..... | 7-10 | TimeView™ | 8-10 |
| RF Inputs..... | 7-12 | Battery Unit..... | 8-10 |
| Checking Input C..... | 7-12 | Option 23/90 | 8-10 |
| Power Measurement | | Measurement Uncertainties..... | 8-11 |
| (CNT-90XL only)..... | 7-13 | Random Uncertainties (1 σ) | 8-11 |
| Performance check procedure of | | Systematic Uncertainties..... | 8-11 |
| Option 28 Pulsed RF | | Total Uncertainty (2 σ) | 8-11 |
| | 7-14 | Time Interval, Pulse Width, Rise/Fall Time | |
| Frequency in Pulse..... | 7-15 | | 8-11 |
| Sensitivity..... | 7-15 | Frequency & Period | 8-11 |
| Accuracy without | | Frequency Ratio f_1/f_2 | 8-12 |
| short-pulse compensation..... | 7-16 | Phase | 8-12 |
| Accuracy with | | Duty Factor | 8-12 |
| short-pulse compensation..... | 7-16 | Calibration..... | 8-13 |
| Pulse width measurements..... | 7-18 | Definition of Terms | 8-13 |
| PRI measurements..... | 7-19 | General Specifications | 8-13 |
| Power measurement..... | 7-19 | Environmental Data..... | 8-13 |
| Power sensitivity..... | 7-20 | Power Requirements..... | 8-13 |
| Power accuracy..... | 7-20 | Dimensions & Weight..... | 8-14 |
| Battery Supply | 7-21 | Ordering Information | 8-14 |
| Option 23/90 for CNT-90 & CNT-90XL | | Timebase Options..... | 8-15 |
| only..... | 7-21 | Explanations..... | 8-15 |
| 8 Specifications | | CNT-90XL | 8-16 |
| CNT-90 | 8-2 | Introduction..... | 8-17 |
| Introduction..... | 8-3 | Measurement Functions | 8-17 |
| Measurement Functions..... | 8-3 | Frequency A, B, C | 8-17 |
| Frequency A, B, C..... | 8-3 | Frequency Burst A, B | 8-17 |
| Frequency Burst A, B, C..... | 8-3 | Period A, B, C Average..... | 8-17 |
| Period A, B, C Average | 8-3 | Period A, B Single | 8-17 |
| Period A, B Single..... | 8-4 | Ratio A/B, B/A, C/A, C/B..... | 8-17 |
| Ratio A/B, B/A, C/A, C/B | 8-4 | Time Interval A to B, B to A, A to A, B to B | |
| Time Interval A to B, B to A, A to A, B to B | | | 8-17 |
| | 8-4 | Pulse Width A, B..... | 8-18 |
| Pulse Width A, B | 8-4 | Rise and Fall Time A, B..... | 8-18 |
| Rise and Fall Time A, B..... | 8-4 | Phase A Rel. B, B Rel. A | 8-18 |
| Phase A Rel. B, B Rel. A..... | 8-5 | Duty Factor A, B | 8-18 |
| Duty Factor A, B..... | 8-5 | V _{max} , V _{min} , V _{p-p} A, B | 8-18 |
| V _{max} , V _{min} , V _{p-p} A, B | 8-5 | Power C | 8-18 |
| Timestamping A, B, C | 8-6 | Pulsed RF parameters input C | |
| Auto Set / Manual Set | 8-6 | (option 28 only)..... | 8-19 |
| | | Timestamping A, B | 8-19 |
| | | Auto Set / Manual Set..... | 8-19 |

| | | | |
|--|-------------|--|-------------|
| Input and Output Specifications | 8-19 | Input and Output Specifications | 8-35 |
| Inputs A and B | 8-19 | Inputs A and B | 8-35 |
| Input C | 8-20 | Input C (Option 10) | 8-35 |
| Rear Panel Inputs & Outputs | 8-20 | Input C (Option 13) | 8-36 |
| Auxiliary Functions | 8-20 | Input C (Options 14 & 14B) | 8-36 |
| Trigger Hold-Off | 8-20 | Rear Panel Inputs & Outputs | 8-36 |
| External Start/Stop Arming | 8-20 | Auxiliary Functions | 8-37 |
| Statistics | 8-20 | Trigger Hold-Off | 8-37 |
| Mathematics | 8-20 | External Start/Stop Arming | 8-37 |
| Other Functions | 8-20 | Statistics | 8-37 |
| Display | 8-21 | Mathematics | 8-38 |
| GPIB Interface | 8-21 | Other Functions | 8-38 |
| USB Interface | 8-21 | Display | 8-38 |
| TimeView™ | 8-21 | GPIB Interface | 8-38 |
| Battery Unit | 8-21 | USB Interface | 8-39 |
| Option 23/90 | 8-21 | TimeView™ | 8-39 |
| Measurement Uncertainties | 8-22 | Measurement Uncertainties | 8-40 |
| Random Uncertainties (1 σ) | 8-22 | Random Uncertainties (1 σ) | 8-40 |
| Systematic Uncertainties | 8-22 | Systematic Uncertainties | 8-40 |
| Total Uncertainty (2 σ) | 8-22 | Total Uncertainty (2 σ) | 8-40 |
| Time Interval, Pulse Width, Rise/Fall Time | 8-22 | Time Interval, Pulse Width, Rise/Fall Time | 8-40 |
| Frequency & Period A, B | 8-22 | Frequency & Period | 8-41 |
| Frequency & Period C | 8-22 | Frequency Ratio f_1/f_2 | 8-41 |
| Frequency Ratio f_A/f_B or f_B/f_A | 8-23 | Phase | 8-41 |
| Frequency Ratio f_C/f_A or f_C/f_B | 8-23 | Duty Factor | 8-41 |
| Phase | 8-23 | Calibration | 8-42 |
| Duty Factor | 8-23 | Definition of Terms | 8-42 |
| Calibration | 8-23 | General Specifications | 8-42 |
| Definition of Terms | 8-23 | Environmental Data | 8-42 |
| General Specifications | 8-24 | Power Requirements | 8-43 |
| Environmental Data | 8-24 | Dimensions & Weight | 8-43 |
| Power Requirements | 8-24 | Ordering Information | 8-43 |
| Dimensions & Weight | 8-24 | Timebase Options CNT-91 | 8-44 |
| Ordering Information | 8-24 | Explanations | 8-44 |
| Timebase Options | 8-25 | Timebase Specifications CNT-91R | 8-45 |
| Explanations | 8-25 | Explanations | 8-45 |
| CNT-91(R) | 8-30 | CNT-91R/71B | 8-46 |
| Introduction | 8-31 | Introduction | 8-47 |
| Measurement Functions | 8-31 | Measurement Functions | 8-47 |
| Frequency A, B, C | 8-31 | Frequency A, B, C | 8-47 |
| Frequency Burst A, B, C | 8-31 | Frequency Burst A, B, C | 8-47 |
| Period A, B, C Average | 8-31 | Period A, B, C Average | 8-47 |
| Period A, B Single | 8-32 | Period A, B Single | 8-48 |
| Period A, B Back-to-Back | 8-32 | Period A, B Back-to-Back | 8-48 |
| Ratio A/B, B/A, C/A, C/B | 8-32 | Ratio A/B, B/A, C/A, C/B | 8-48 |
| Time Interval A to B, B to A, A to A, B to B | 8-32 | Time Interval A to B, B to A, A to A, B to B | 8-48 |
| Pulse Width A, B | 8-32 | Pulse Width A, B | 8-48 |
| Rise and Fall Time A, B | 8-32 | Rise and Fall Time A, B | 8-48 |
| Time Interval Error (TIE) A, B | 8-33 | Time Interval Error (TIE) A, B | 8-49 |
| Phase A Rel. B, B Rel. A | 8-33 | Phase A Rel. B, B Rel. A | 8-49 |
| Duty Factor A, B | 8-33 | Duty Factor A, B | 8-49 |
| V_{max} , V_{min} , V_{p-p} A, B | 8-33 | V_{max} , V_{min} , V_{p-p} A, B | 8-49 |
| Totalize A, B, A+B, A-B, A/B | 8-34 | Totalize A, B, A+B, A-B, A/B | 8-50 |
| Timestamping A, B | 8-34 | Timestamping A, B | 8-50 |
| Auto Set / Manual Set | 8-34 | Auto Set / Manual Set | 8-50 |

| | |
|--|------|
| Input and Output Specifications | 8-51 |
| Inputs A and B | 8-51 |
| Input C | 8-51 |
| Rear Panel Inputs & Outputs | 8-52 |
| Auxiliary Functions | 8-52 |
| Trigger Hold-Off | 8-52 |
| External Start/Stop Arming | 8-52 |
| Statistics | 8-52 |
| Mathematics | 8-53 |
| Other Functions | 8-53 |
| Display | 8-53 |
| GPIB Interface | 8-53 |
| USB Interface | 8-54 |
| TimeView™ | 8-54 |
| Measurement Uncertainties | 8-55 |
| Random Uncertainties (1σ) | 8-55 |
| Systematic Uncertainties | 8-55 |
| Total Uncertainty (2σ) | 8-55 |
| Time Interval, Pulse Width, Rise/Fall Time | 8-55 |
| Frequency & Period | 8-56 |
| Frequency Ratio f_1/f_2 | 8-56 |
| Phase | 8-56 |
| Duty Factor | 8-56 |
| Calibration | 8-57 |
| Definition of Terms | 8-57 |
| General Specifications | 8-57 |
| Environmental Data | 8-57 |
| Power Requirements | 8-58 |
| Dimensions & Weight | 8-58 |
| Timebase Specifications CNT-91R/71B | 8-59 |
| Explanations | 8-59 |

9 Index

10 Service

| | |
|--------------------------------|------|
| Sales and Service Office | 10-2 |
|--------------------------------|------|

11 Appendix

| | |
|----------------|------|
| New Look | 11-2 |
|----------------|------|

GENERAL INFORMATION

About this Manual

This manual contains directions for use that apply to the Timer/Counter/Analyzers CNT-90 and CNT-91 as well as the Frequency Calibrator/Analyzer CNT-91R and CNT-91R/71B and the Microwave Counter/Analyzer CNT-90XL.

In order to simplify the references, these instruments are further referred to throughout this manual as the '9X', whenever the information applies to all types. Differences are clearly marked.

Examples:

- CNT-90 means CNT-90 and CNT-90/XL
- CNT-90/91 means CNT-90 and CNT-91
- CNT-91(R) means CNT-91, CNT-91R and CNT-91R/71B

Chapter 8; Specifications is divided into four separate sections to increase legibility. Much of the contents is common, so redundant data is the price in this case.

Warranty

The Warranty Statement is part of the folder *Important Information* that is included with the shipment.

Declaration of Conformity

The complete text with formal statements concerning product identification, manufacturer and standards used for type testing is available on request.

Preparation for Use

Preface

Introduction

Congratulations on your choice of instrument. It will serve you well and stay ahead of most competition for many years to come.

Your instrument is designed to bring you a new dimension to bench-top and system counting. It gives significantly increased performance compared to traditional Timer/Counters. The '9X' offers the following advantages:

- 12 digits of frequency resolution per second and 50 or 100 ps resolution, as a result of high-resolution interpolating reciprocal counting.
- Optional oven-controlled timebase oscillators, except the CNT-91R & CNT-91R/71B, which have a fixed ultra-stable rubidium oscillator.

—*CNT-90, CNT-91(R)*:

A variety of RF prescaler options with upper frequency limits ranging from 3 GHz to 20 GHz.

—*CNT-91R/71B*:

5 Reference frequency outputs covering 100 kHz, 1 MHz, 5 MHz and 10 MHz.

—*CNT-90XL*:

A number of microwave inputs with upper frequency limits ranging from 27 GHz to 60 GHz.

—*CNT-90(XL)*:

Optional built-in Li-Ion battery supply realizes instant high-precision measurements in the field and true UPS operation.

—Integrated high performance GPIB interface using SCPI commands.

—A fast USB interface that replaces the traditional but slower RS-232 serial interface.

—Timestamping; the counter records the relative position in time of measurements with high resolution and accuracy.

—A high measurement rate of up to 250 k readings/s to internal memory.

Powerful and Versatile Functions

A unique performance feature in your new instrument is the comprehensive arming possibilities, which allow you to characterize virtually any type of complex signal concerning frequency and time.

For instance, you can insert a delay between the external arming condition and the actual arming of the counter. Read more about Arming in Chapter 5, "Measurement Control".

In addition to the traditional measurement functions of a timer/counter, these instruments have a multitude of other functions such as phase, duty factor, rise/fall-time and peak voltage. The counter can perform all measurement functions on both main inputs (A & B). Most measurement functions can be armed, either via one of the main inputs or via a separate arming channel (E).

By using the built-in mathematics and statistics functions, the instrument can process the measurement results on your benchtop, without the need for a controller. Math functions include inversion, scaling and offset. Statistics functions include Max, Min and Mean as well as Standard and Allan Deviation on sample sizes up to 2×10^9 .

No Mistakes

You will soon find that your instrument is more or less self-explanatory with an intuitive user interface. A menu tree with few levels makes the timer/counter easy to operate. The large backlit graphic LCD is the center of information and can show you several signal parameters at the same time as well as setting status and operator messages.

Statistics based on measurement samples can easily be presented as histograms or trend plots in addition to standard numerical measurement results like max, min, mean and standard deviation.

The AUTO function triggers automatically on any input waveform. A bus-learn mode simplifies GPIB programming. With bus-learn mode, manual counter settings can be transferred to the controller for later reprogramming. There is no need to learn code and syntax for each individual counter setting if you are an occasional GPIB bus user.

Design Innovations

State of the Art Technology Gives Durable Use

These counters are designed for quality and durability. The design is highly integrated. The digital counting circuitry consists of just one custom-developed FPGA and a 32-bit microcontroller. The high integration and low component count reduces power consumption and results in an MTBF of 30,000 hours. Modern surface-mount technology ensures high production quality. A rugged mechanical construction, including a metal cabinet that withstands mechanical shocks and protects against EMI, is also a valuable feature.

High Resolution

The use of *reciprocal interpolating counting* in this new counter results in excellent relative resolution: 12 digits/s for *all* frequencies.

The measurement is synchronized with the input cycles instead of the timebase. Simultaneously with the normal "digital" counting, the counter makes analog measurements of the time between the start/stop trigger events and the next following clock pulse. This is done in four identical circuits by charging an integrating capacitor with a constant current, starting at the trigger event. Charging is stopped at the leading edge of the first following clock pulse. The stored charge in the integrating capacitor represents the time difference between the start trigger event and the leading edge of the first following clock pulse. A similar charge integration is made for the stop trigger event.

When the "digital" part of the measurement is ready, the stored charges in the capacitors are measured by means of Analog/Digital Converters.

The counter's microprocessor calculates the result after completing all measurements, i.e. the digital time measurement and the analog interpolation measurements.

The result is that the basic "digital resolution" of + 1 clock pulse (10 ns) is reduced to 100 ps for the CNT-90 and 50 ps for the CNT-91(R).

Since the measurement is synchronized with the input signal, the resolution for frequency measurements is very high and independent of frequency.

The counters have 14 display digits to ensure that the display itself does not restrict the resolution.

Remote Control

This instrument is programmable via two interfaces, GPIB and USB.

The GPIB interface offers full general functionality and compliance with the latest standards in use, the IEEE 488.2 1987 for HW and the SCPI 1999 for SW.

In addition to this 'native' mode of operation there is also a second mode that emulates the Agilent 53131/132 command set for easy exchange of instruments in operational ATE systems.

The USB interface is mainly intended for the lab environment in conjunction with the optional TimeView™ analysis software. The communication protocol is a proprietary version of SCPI.

Fast GPIB Bus

These counters are not only extremely powerful and versatile bench-top instruments, they also feature extraordinary bus properties.

The bus transfer rate is up to 4000 triggered measurements/s in CNT-91(R). Array measurements to the internal memory can reach 250 k measurements/s.

This very high measurement rate makes new measurements possible. For example, you can perform *jitter analysis* on several tens of thousands of pulse width measurements and capture them in less than a second.

An extensive Programmer's Handbook helps you understand SCPI and counter programming.

The counter is easy to use in GPIB environments. A built-in *bus-learn* mode enables you to make all counter settings manually and transfer them to the controller. The response can later be used to reprogram the counter to the same settings. This eliminates the need for the occasional user to learn all individual programming codes.

Complete (manually set) counter settings can also be stored in 20 internal memory locations and can easily be recalled on a later occasion. Ten of them can be user protected.

Safety

Introduction

Even though we know that you are eager to get going, we urge you to take a few minutes to read through this part of the introductory chapter carefully before plugging the line connector into the wall outlet.

This instrument has been designed and tested for Measurement Category I, Pollution Degree 2, in accordance with EN/IEC 61010-1:2001 and CAN/CSA-C22.2 No. 61010-1-04 (including approval). It has been supplied in a safe condition.

Study this manual thoroughly to acquire adequate knowledge of the instrument, especially the section on *Safety Precautions* hereafter and the section on *Installation* on page 1-7.

Safety Precautions

All equipment that can be connected to line power is a potential danger to life. Handling restrictions imposed on such equipment should be observed.

To ensure the correct and safe operation of the instrument, it is essential that you follow generally accepted safety procedures in addition to the safety precautions specified in this manual.

The instrument is designed to be used by trained personnel only. Removing the cover for repair, maintenance, and adjustment of the instrument must be done by qualified personnel who are aware of the hazards involved.

The warranty commitments are rendered void if unauthorized access to the interior of the instrument has taken place during the given warranty period.

Caution and Warning Statements

CAUTION: Shows where incorrect procedures can cause damage to, or destruction of equipment or other property.

WARNING: Shows a potential danger that requires correct procedures or practices to prevent personal injury.

Symbols



Shows where the protective ground terminal is connected inside the instrument. **Never** remove or loosen this screw.



This symbol is used for identifying the functional ground of an I/O signal. It is always connected to the instrument chassis.



Indicates that the operator should consult the manual.

One such symbol is printed on the instrument, below the A and B inputs. It points out that the damage level for the input voltage decreases from 350 V_p to 12V_{rms} when you switch the input impedance from 1 MΩ to 50 Ω.

If in Doubt about Safety

Whenever you suspect that it is unsafe to use the instrument, you must make it inoperative by doing the following:

- Disconnect the line cord
- Clearly mark the instrument to prevent its further operation



Fig. 1-1 Do not overlook the safety instructions!

- Inform your Pendulum representative.

For example, the instrument is likely to be unsafe if it is visibly damaged.

Disposal of Hazardous Materials

■ CNT-90 & CNT-90XL only

If your instrument was ordered with a built-in battery supply (Option 23/90), it contains 12 Li-Ion cells arranged as a fixed battery pack with internal protection circuitry.

Even though this type of cell does not cause environmental damage in the same way as NiCd, for instance, you should dispose of a worn-out battery pack at an authorized recycling station or return it to Pendulum.

Note: Individual cells cannot be replaced.

Environmental Considerations

This section provides information about the environmental impact of the product.

Product End-of-Life Handling

Observe the following guidelines when recycling an instrument or component:

Equipment recycling

Production of this equipment required the extraction and use of natural resources. The equipment may contain substances that could be harmful to the environment or human health if improperly handled at the product's end of life. To avoid release of such substances into the environment and to reduce the use of natural resources, we encourage you to recycle this product in an appropriate system that will ensure that most of the materials are reused or recycled appropriately.

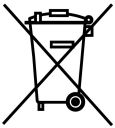

This symbol indicates that this product complies with European Union requirements according to Directives 2012/19/EU and 2006/66/EC on waste electrical and electronic equipment (WEEE) and batteries.

Unpacking

Check that the shipment is complete and that no damage has occurred during transportation. If the contents are incomplete or damaged, file a claim with the carrier immediately. Also notify your local Pendulum sales or service organization in case repair or replacement may be required.

- Getting Started Manual
- User's Manual
- Programmer's Handbook
- Service Manual (CNT-91R/71B only)

Check List

The shipment should contain the following:

- Counter/Timer/Analyzer CNT-90/91 or Frequency Calibrator/Analyzer CNT-91R or CNT-91R/71B or Microwave Counter/Analyzer CNT-90XL
- Line cord
- Printed version of the *Getting Started Manual*
- Brochure with Important Information
- Certificate of Calibration
- Options you ordered should be installed. See *Identification* below.
- CD including the following documentation in PDF:

Identification

The type plate on the rear panel shows type number and serial number. See illustrations on page 2-5 and 2-6. Installed options are listed under the menu *User Options - About, where* you can also find information on firmware version and calibration date. See page 2-15.

The CNT-91R/71B version is identified by a unique identification marking, or UID. This permanent tag contains a barcode and allows customers to track easily their inventory and property.

Installation

Supply Voltage

■ Setting

The Counter may be connected to any AC supply with a voltage rating of 100-240 Vac, 50-400 Hz (Nom.). The counter automatically adjusts itself to the input line voltage.

■ Fuse

The secondary supply voltages are electronically protected against overload or short circuit. The primary line voltage side is protected by a fuse located on the power supply unit. The fuse rating covers the full voltage range. Consequently there is no need for the user to replace the fuse under any operating conditions, nor is it accessible from the outside.

CAUTION: If this fuse is blown, it is likely that the power supply is badly damaged. Do not replace the fuse. Send the counter to the local Service Center.

Removing the cover for repair, maintenance and adjustment must be done by qualified and trained personnel only, who are fully aware of the hazards involved.

The warranty commitments are rendered void if unauthorized access to the interior of the instrument has taken place during the given warranty period.

Battery Supply

■ CNT-90 & CNT-90XL only

It is possible to run the counter from an optional battery supply, Option 23/90.

You must charge the battery before use or storage. The counter charges the battery automatically when connected to line power or an external DC source, whether the instrument is in standby or turned on. See the specifications for charging time in different modes of operation.



Grounding

Grounding faults in the line voltage supply will make any instrument connected to it dangerous. Before connecting any unit to the power line, you must make sure that the protective ground functions correctly. Only then can a unit be connected to the power line and only by using a three-wire line cord. No other method of grounding is permitted. Extension cords must always have a protective ground conductor.

CAUTION: If a unit is moved from a cold to a warm environment, condensation may cause a shock hazard. Ensure, therefore, that the grounding requirements are strictly met.

WARNING: Never interrupt the grounding cord. Any interruption of the protective ground connection inside or outside the instrument or disconnection of the protective ground terminal is likely to make the instrument dangerous.

Orientation and Cooling

The counter can be operated in any position desired. Make sure that the air flow through the ventilation slots at the top, and side panels is not obstructed. Leave 5 centimeters (2 inches) of space around the counter.

Fold-Down Support

For bench-top use, a fold-down support is available for use underneath the counter. This support can also be used as a handle to carry the instrument.

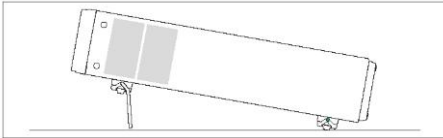

Fig. 1-2 Fold-down support for comfortable bench-top use.

Capacitors inside the instrument can hold their charge even if the instrument has been separated from all voltage sources.

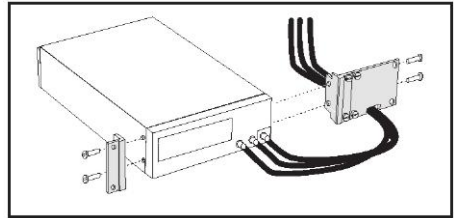

Fig. 1-4 Fitting the rack mount brackets on the counter.

Rackmount Adapter

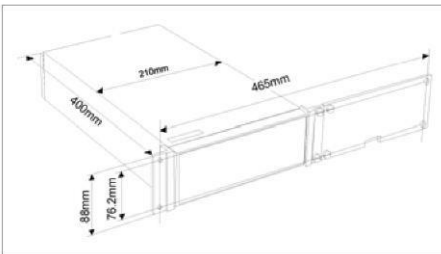

Fig. 1-3 Dimensions for rackmounting hardware.

If you have ordered a 19-inch rack-mount kit for your instrument, it has to be assembled after delivery of the instrument. The rackmount kit consists of the following:

- 2 brackets, (short, left; long, right)
- 4 screws, M5 x 8
- 4 screws, M6 x 8

WARNING: Do not perform any internal service or adjustment of this instrument unless you are qualified to do so

Before you remove the cover, disconnect mains cord and wait for one minute.

■ Assembling the Rackmount Kit

- Make sure the power cord is disconnected from the instrument.
- Turn the instrument upside down.
- See Fig. 1-5.

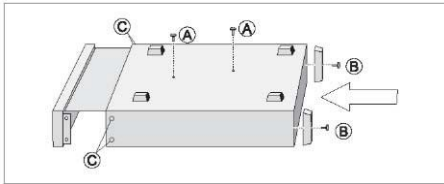

Fig. 1-5 Remove the screws and push the counter out of the cover.

- Undo the two screws (A) and remove them from the cover.
- Remove the rear feet by undoing the two screws (B).
- Remove the four decorative plugs (C) that cover the screw holes on the right and left side of the front panel.
- Grip the front panel and gently push at the rear.
- Pull the instrument out of the cover.
- Remove the four feet from the cover.

Use a screwdriver as shown in the following illustration or a pair of pliers to remove the springs holding each foot, then push out the feet.

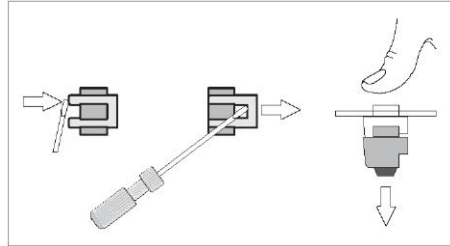

Fig. 1-6 Removing feet from the cover.

- Push the instrument back into the cover. See Fig. 1-5.
- Mount the two rear feet with the screws (B) to the rear panel.
- Put the two screws (A) back.
- Fasten the brackets at the left and right side with the screws included as illustrated in Fig 1-6
- Fasten the instrument in the rack via screws in the four rack-mounting holes

The long bracket has an opening so that cables for Input A, B, and C can be routed inside the rack.

■ Reversing the Rackmount Kit

The instrument may also be mounted to the right in the rack. To do so, swap the position of the two brackets.

Chapter 2

Using the Controls

Basic Controls

A more elaborate description of the front and rear panels including the user interface with its menu system follows after this introductory

survey, the purpose of which is to make you familiar with the layout of the instrument. See also the appendix.

INPUT A

Opens the menu from which you can adjust all settings for Input A like Coupling, Impedance and Attenuation.

INPUT B

Opens the menu from which you can adjust all settings for Input B like Coupling, Impedance and Attenuation.

SETTINGS

Select measurement parameters such as measurement time, number of measurements, and so on.

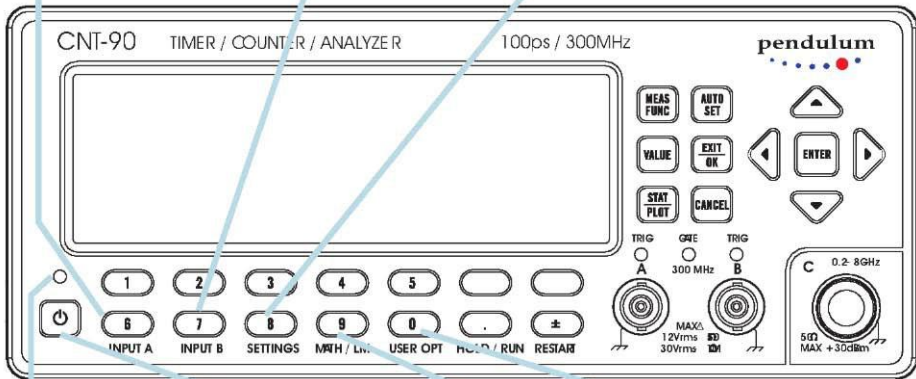

STANDBY LED

The LED lights up when the counter is in STANDBY mode, indicating that power is still applied to an internal optical OCXO, if one has been installed, or to the rubidium oscillator in the CNT-91R.

STANDBY/ON

Toggling secondary power switch. Pressing this button in standby mode turns the counter ON and restores the settings as they were at power-down.

MATH/LIMIT

Menu for selecting one of a set of formulas for modifying the measurement result. Three constants can be entered from the keyboard.

Numerical limits can also be entered for status reporting and recording.

USER OPT.

Controls the following items:

1. Settings memory
2. Calibration
3. Interface
4. Self-test
5. Blank digits
6. About

STAT/PLOT

Enters one of three statistics presentation modes. Switching between the modes is done by toggling the key.

VALUE

Enters the normal numerical presentation mode with one main parameter and a number of auxiliary parameters.

MEAS FUNC

Menu tree for selecting measurement function. You can use the seven softkeys below the display for confirmation.

AUTO SET

Adjusts input trigger voltages automatically to the optimum levels for the chosen measurement function. Double-click for default settings.

CURSOR CONTROL

The cursor position, marked by text inversion on the display, can be moved in four directions.

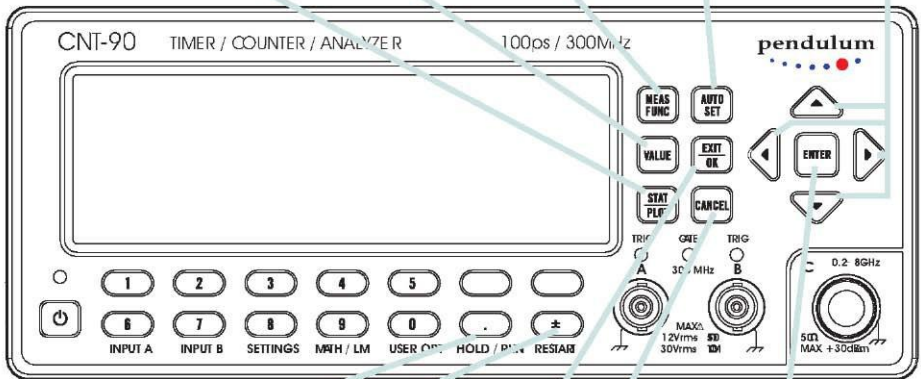

HOLD/RUN

Toggles between HOLD (one-shot) mode and RUN (continuous) mode. Freezes the result after completion of a measurement if HOLD is active.

RESTART

Initiates one new measurement if HOLD is active.

EXIT/OK

Confirms menu selections and moves up one level in the menu tree.

CANCEL

Moves up one menu level without confirming selections made. Exits REMOTE mode if not LOCAL LOCKOUT.

ENTER

Confirms menu selections without leaving the menu level.

Secondary Controls

Connectors & Indicators

GRAPHIC DISPLAY

320 x 97 pixels LCD with backlight for showing measurement results in numerical as well as graphical format. The display is also the center of the dynamic user interface, comprising menu trees, indicators and information boxes.

SOFTKEYS

The function of these seven keys is menu dependent. Actual function is indicated on the LCD. Depressing a softkey is often a faster alternative to moving the cursor to the desired position and then pressing OK.

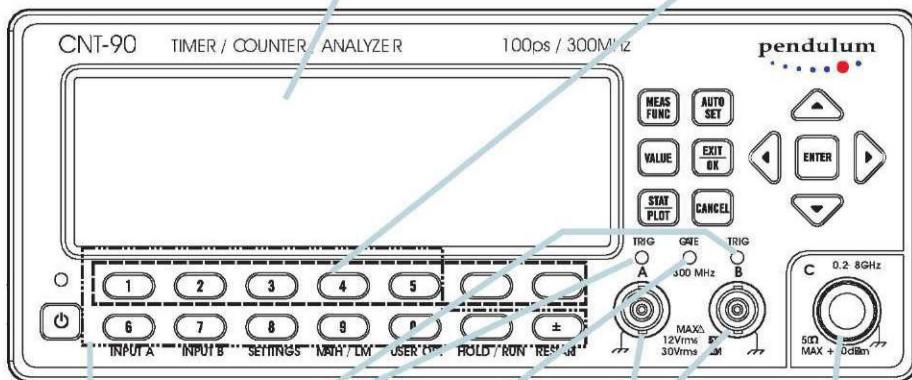

TRIGGER INDICATORS

Blinking LED indicates correct triggering.

GATE INDICATOR

A pending measurement causes the LED to light up.

MAIN INPUTS

The two identical DC coupled channels A & B are used for all types of measurements, either one at a time or both together.

RF/MICROWAVE INPUT

CNT-90/91(R): A number of optional RF prescalers are available.

CNT-90XL: One of a number of microwave converters is mounted.

Conn. type dep. on frequency spec.

NUMERIC INPUT KEYS

Sometimes you may want to enter numeric values like the constants and limits asked for when you are utilizing the postprocessing features in MATH/LIMIT mode. These twelve keys are to be used for this purpose.

Rear Panel

Type Plate

Indicates instrument type and serial number.

Optional Main Input Connectors (not with Option 23/90)

The front panel inputs can be moved to the rear panel by means of an optional cable kit. Note that the input capacitance will be higher.

Protective Ground Terminal

This is where the protective ground wire is connected inside the instrument. Never tamper with this screw!

Pulse Output

[CNT-91(R) only]
User definable to serve as output for built-in pulse generator, gate indicator or alarm.

Fan

A temp. sensor controls the speed of the fan. Normal bench-top use means low speed, whereas rack-mounting and/or options may result in higher speed.

Line Power Inlet

AC 100-240 Vac, 50-400 Hz (Nom.) no range switching needed.

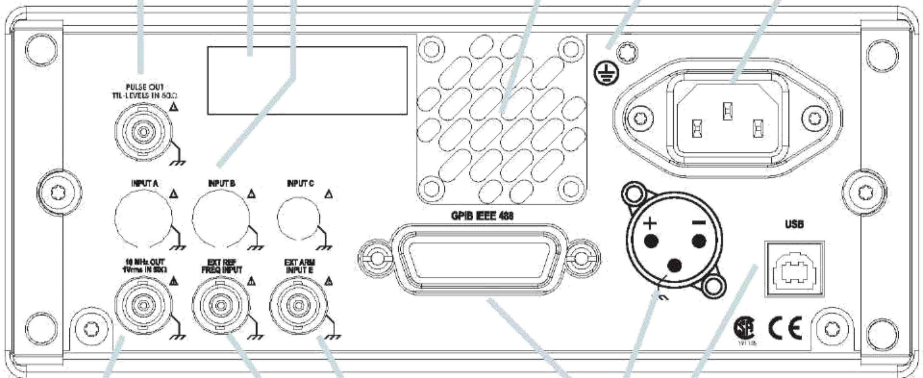

Reference Output 10

MHz derived from the internal or, if present, the external reference.

External Arming Input

See page 5-7.

USB Connector

Universal Serial Bus (USB) for data communication with PC.

External Reference Input

Can be automatically selected if a signal is present and approved as timebase source, see Chapter 9.

GPIB Connector

Address set via User Options Menu.

Ext. DC Connector

Part of Option 23/90 for CNT-90(XL).
Range: 12-18 V Note the polarity.

Rear Panel (CNT-91R/71B)

Type Plate

Indicates instrument type and serial number.

Pulse Output

User definable to serve as output for built-in pulse generator, gate indicator or alarm.

Additional output frequencies Connectors

These connectors provide additional output frequencies which are, from left to right, 100kHz, 1MHz, 5MHz and 10MHz.

Protective Ground Terminal

This is where the protective ground wire is connected inside the instrument. Never tamper with this screw!

Fan

A temp. sensor controls the speed of the fan. Normal bench-top use means low speed, whereas rack-mounting and/or options may result in higher speed.

Line Power Inlet

AC 100-240 Vac, 50-400 Hz (Nom.), no range switching needed.

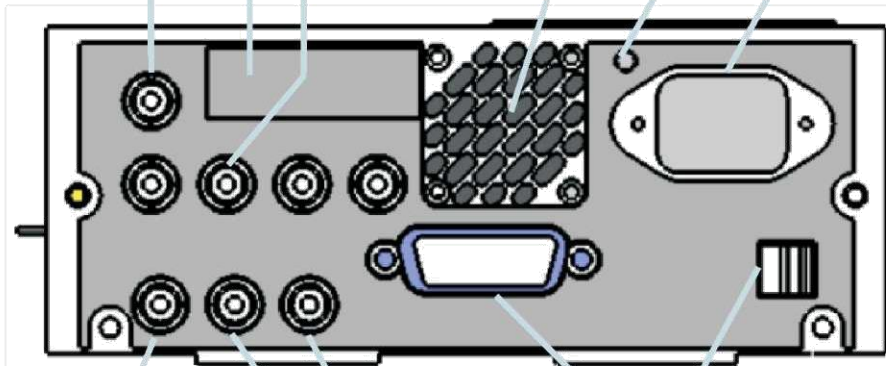

Reference Output

10 MHz derived from the internal or, if present, the external reference.

External Arming Input

See page 5-7.

USB Connector

Universal Serial Bus (USB) for data communication with PC.

External Reference Input

Can be automatically selected if a signal is present and approved as timebase source, see Chapter 9.

GPIB Connector

Address set via User Options Menu.

Description of Keys

Power

The **ON/OFF** key is a toggling secondary power switch. Part of the instrument is always ON as long as power is applied, and this standby condition is indicated by a red LED above the key. This indicator is consequently not lit while the instrument is in operation.

■ CNT-91R and CNT-91R/71B only

While the rubidium oscillator is warming up, an open padlock symbol labeled RB is flashing at the top right corner of the display, indicating that the control loop is not locked. Normal time to lock is about 5 min. Do not start measuring until the unlock symbol disappears.

New Message Box

Information exchange between the rubidium oscillator and the CPU takes place over a serial bus. Any malfunction in the UART-controlled communication link will be reported in a pop-up message box on the display.

■ CNT-90(XL) w. Option 23/90

The User Interface Screens have two indicators near the upper right corner of the display. One is a power supply status indicator and the other is a battery charging level indicator.

The status indicator shows:

- a fixed battery symbol when the internal battery is the active power source
- a charging battery symbol when the internal battery is being charged
- a power plug symbol when the mains is the active power source
- a power plug symbol on top of a battery symbol when the instrument has been prepared for UPS operation and charging is not going on

The charging level indicator shows:

- the relative charging level in percent

Select Function

This hard key is marked **MEAS FUNC.** When you depress it, one of the menus below will open.



Fig. 2-1 CNT-90: Select measurement function.



Fig. 2-2 CNT-90XL: Select measurement function.



Fig. 2-3 CNT-91(R): Select measurement function.

The current selection is indicated by text inversion that is also indicating the cursor position. Select the measurement function you want by depressing the corresponding softkey right below the display.

Alternatively you can move the cursor to the wanted position with the **RIGHT/LEFT** arrow keys. Confirm by pressing **ENTER**.

A new menu will appear where the contents depend on the function. If you for instance

have selected **Frequency**, you can then select between **Frequency**, **Frequency Ratio** and **Frequency Burst**. Finally you have to decide which input channel(s) to use.

Autoset/Preset

By depressing this key once after selecting the wanted measurement function and input channel, you will most probably get a measurement result. The **AUTOSET** system ensures that the trigger levels are set optimally for each combination of measurement function and input signal amplitude, provided relatively normal signal waveforms are applied. If **Manual Trigger** has been selected before pressing the **AUTOSET** key, the system will make the necessary adjustments once (**Auto Once**) and then return to its inactive condition.

AUTOSET performs the following functions:

- Set automatic trigger levels
- Switch attenuators to 1x
- Turn on the display
- Set Auto Trig Low Freq to
 - 100 Hz, if $f_{in} > 100\text{Hz}$, or to
 - f_{in} , if $10 < f_{in} < 100\text{Hz}$, or to
 - 10 Hz, if $f_{in} < 10\text{Hz}$

A higher value means faster settling time.

By depressing this key twice within two seconds, you will enter the **Preset** mode, and a more extensive automatic setting will take place. In addition to the functions above, the following functions will be performed:

- Set **Meas Time** to **200 ms**
- Switch off **Hold-Off**
- Set **HOLD/RUN** to **RUN**
- Switch off **MATH/LIM**
- Switch off **Analog** and **Digital Filters**

- Set **Timebase Ref** to **Auto**
- Switch off **Arming**

■ Default Settings

An even more comprehensive preset function can be performed by recalling the factory default settings. See page 2-16.

Move Cursor

There are four arrow keys for moving the cursor, normally marked by text inversion, around the menu trees in two dimensions.

Display Contrast

When no cursor is visible (no active menu selected), the **UP/DOWN** arrows are used for adjusting the LCD display contrast ratio.

Enter

The key marked **ENTER** enables you to confirm a choice without leaving your menu position.

Save & Exit

This hard key is marked **EXIT/OK**. You will confirm your selection by depressing it, and at the same time you will leave the current menu level for the next higher level.

Don't Save & Exit

This hard key is marked **CANCEL**. By depressing it you will enter the preceding menu level without confirming any selections made at the current level.

If the instrument is in **REMOTE** mode, this key is used for returning to **LOCAL** mode, unless **LOCAL LOCKOUT** has been programmed.

Presentation Modes

■ VALUE

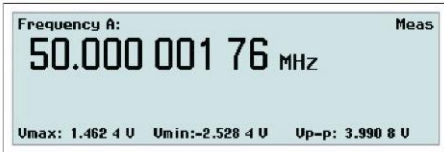

Fig. 2-4 Main and aux. parameters.

Value mode gives single line numerical presentation of individual results, where the main parameter is displayed in large characters with full resolution together with a number of auxiliary parameters in small characters with limited resolution.

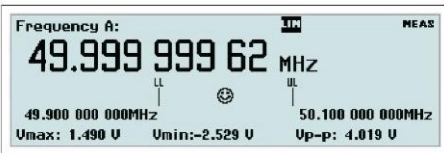

Fig. 2-5 Limits presentation.

If *Limit Behavior* is set to *Alarm* and *Limit Mode* is set to *Range* you can visualize the deviation of your measurements in relation to the set limits. The numerical readout is now combined with a traditional analog pointer-type instrument, where the current value is represented by a "smiley". The limits are presented as numerical values below the main parameter, and their positions are marked with vertical bars labelled LL (lower limit) and UL (upper limit) on the autoscaled graph.

If one of the limits has been exceeded, the limit indicator at the top of the display will be flashing. In case the current measurement is out of the visible graph area, it is indicated by means of a left or a right arrowhead.

■ STAT/PLOT

If you want to treat a number of measurements with statistical methods, this is the key to operate. There are three display modes available by toggling the key:

- Numerical
- Histogram
- Trend Plot

Numerical



Fig. 2-6 Statistics presented numerically.

In this mode the statistical information is displayed as numerical data containing the following elements:

- Mean: mean value
- Max: maximum value
- Min: minimum value
- P-P: peak-to-peak deviation
- Adev: Allan deviation
- Std: Standard deviation

Histogram

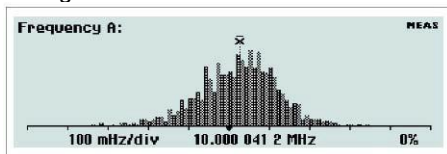

Fig. 2-7 Statistics presented as a histogram.

The bins in the histogram are always autoscaled based on the measured data. Limits, if enabled, and center of graph are shown as vertical dotted lines. Data outside the limits are not used for autoscaling but are replaced by an

arrow indicating the direction where non-displayed values have been recorded.

Trend Plot

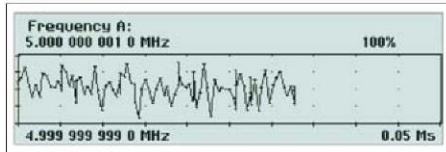

Fig. 2-8 Running trend plot.

This mode is used for observing periodic fluctuations or possible trends. Each plot terminates (if **HOLD** is activated) or restarts (if **RUN** is activated) after the set number of samples. The trend plot is always autoscaled based on the measured data, starting with 0 at restart. Limits are shown as horizontal lines if enabled.

■ Remote

When the instrument is controlled from the GPIB bus or the USB bus, the operating mode changes to **Remote**, indicated by the label **REM** on the display. All front panel keys except **CANCEL** are then disabled. See also page 2-8 for more information on this key.

Entering Numeric Values

Sometimes you may want to enter constants and limits in a value input menu, for instance one of those that you can reach when you press the **MATH/LIMIT** key.

You may also want to select a value that is not in the list of fixed values available by pressing the **UP/DOWN** arrow keys. One example is **Meas Time** under **SETTINGS**.

A similar situation arises when the desired value is too far away to reach conveniently by incrementing or decrementing the original value with the **UP/DOWN** arrow keys. One

example is the **Trig Lvl** setting as part of the **INPUT A (B)** settings.

Whenever it is possible to enter numeric values, the keys marked with **0-9**, (decimal point) and \pm (stands for *Change Sign*) take on their alternative numeric meaning.

It is often convenient to enter values using the scientific format. For that purpose, the rightmost softkey is marked **EE** (stands for *Enter Exponent*), making it easy to switch between the mantissa and the exponent.

Press **EXIT/OK** to store the new value or **CANCEL** to keep the old one.

Hard Menu Keys

These keys are mainly used for opening fixed menus from which further selections can be made by means of the softkeys or the cursor/select keys.

■ Input A (B)



Fig. 2-9 Input settings menu.

By depressing this key, the bottom part of the display will show the settings for Input A (B).

The active settings are in bold characters and can be changed by depressing the corresponding softkey below the display. You can also move the cursor, indicated by text inversion, to the desired position with the **RIGHT/LEFT** arrow keys and then change the active setting with the **ENTER** key.

The selections that can be made using this menu are:

- Trigger Slope: positive or negative, indicated by corresponding symbols
- Coupling: AC or DC
- Impedance: 50 Ω or 1 M Ω
- Attenuation: 1x or 10x
- Trigger:¹ Manual or Auto
- Trigger Level:² numerical input via front panel keyboard. If Auto Trigger is active, you can change the default trigger level manually as a percentage of the amplitude.
- Filter:³ On or Off

- Notes:
- 1 Always **Auto** when measuring risetime or falltime
 - 2 The absolute level can either be adjusted using the up/down arrow keys or by pressing ENTER to reach the numerical input menu.
 - 3 Pressing the corresponding softkey or ENTER opens the Filter Settings menu. See Fig. 2-10. You can select a fixed 100 kHz analog filter or an adjustable digital filter. The equivalent cutoff frequency is set via the value input menu that opens if you select Digital LP Frequency from the menu.



Fig. 2-10 Selecting analog or digital filter.

■ Input B

The settings under Input B are equal to those under Input A.

■ Settings

This key accesses a host of menus that affect the measurement. The figure above is valid after changing the default measuring time to 10 ms.

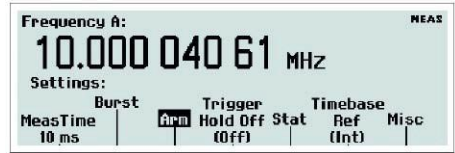

Fig. 2-11 The main settings menu.

Meas Time



Fig. 2-12 Submenu for entering measuring time.

This value input menu is active if you select a frequency function. Longer measuring time means fewer measurements per second and gives higher resolution.

Burst

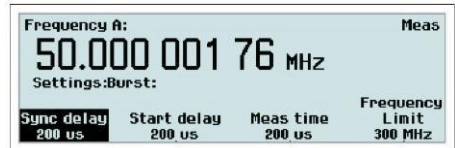

Fig. 2-13 Entering burst parameters.

This settings menu is active if the selected measurement function is BURST - a special case of FREQUENCY - and facilitates measurements on pulse-modulated signals. Both the carrier frequency and the modulating frequency - the pulse repetition frequency (PRF) - can be measured, often without the support of an external arming signal.

Arm



Fig. 2-14 CNT-90 & CNT-90XL: Setting arming conditions.

start. A typical use is to clean up signals generated by bouncing relay contacts.



Fig. 2-15 CNT-91(R): Setting arming conditions.

Arming is the general term used for the means to control the actual start/stop of a measurement. The normal free-running mode is inhibited and triggering takes place when certain pretrigger conditions are fulfilled.

The signal or signals used for initiating the arming can be applied to three channels (A, B, E), and the start channel can be different from the stop channel. All conditions can be set via this menu.

NOTE: **Stop Delay** can only be used for realizing the function **Timed Totalize** in the CNT-91(R).

Trigger Hold-Off



Fig. 2-16 The trigger hold-off submenu.

A value input menu is opened where you can set the delay during which the stop trigger conditions are ignored after the measurement

Statistics

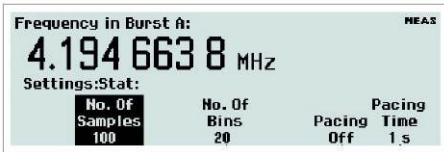

Fig. 2-17 Entering statistics parameters.

In this menu you can do the following:

- Set the number of samples used for calculation of various statistical measures.
- Set the number of bins in the histogram view.
- Pacing
 - The delay between measurements, called pacing, can be set to ON or OFF, and the time can be set within the range 2 μ s - 500 s.

Timebase Reference



Fig. 2-18 Selecting timebase reference source.

Here you can decide if the counter is to use an **Internal** or an **External** timebase. A third alternative is **Auto**. Then the external timebase will be selected if a valid signal is present at the reference input. The *EXT REF* indicator at the upper right corner of the display shows that the instrument is using an external timebase reference.

Miscellaneous



Fig. 2-19 CNT-90: The 'Misc' submenu.



Fig. 2-22 CNT-90XL: The 'Input C Acquisition' submenu.



Fig. 2-20 CNT-90XL: The 'Misc' submenu.

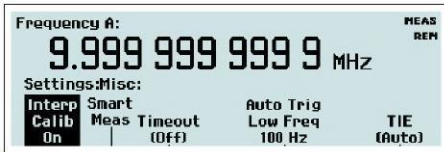

Fig. 2-21 CNT-91(R): The 'Misc' submenu.

The options in this menu are:

- Smart Measure with submenus:
 - Smart Time Interval (valid only if the selected measurement function is Time Interval)
The counter decides by means of timestamping which measurement channel precedes the other.
 - Smart Frequency (valid only if the selected measurement function is Frequency or Period Average) By means of continuous timestamping and regression analysis, the resolution is increased for measuring times between 0.2 s and 100 s.
- Input C Acquisition (CNT-90XL only) Auto means that the whole specified frequency range is scanned for valid input signals.
- Timeout
From this submenu you can activate/deactivate the timeout function and set the maximum time the instrument will wait for a pending measurement to finish before outputting a zero result. The range is 10 ms to 1000 s.
- Interpolator Calibration
By switching off the interpolator calibration, you can increase the measurement speed at the expense of accuracy.
- TIE (CNT-91 only)
From a submenu you can either let the counter choose the reference frequency automatically (Auto) or enter it manually.

Manual means that a narrow band around the manually entered center frequency is monitored for valid input signals. This mode is compulsory when measuring burst signals but is also recommended for FM signals, when the approximate frequency is known. An additional feature is that the measurement results are presented much faster, as the acquisition process is skipped.

NOTE: Signal frequencies outside the manual capture range may cause erroneous results. In order to draw the operator's attention to this eventuality, the sign "M.ACQ" is visible in the upper right corner of the display.

■ Math/Limit

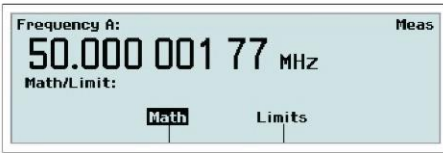

Fig. 2-23 Selecting Math or Limits parameters.

You enter a menu where you can choose between inputting data for the *Mathematics* or the *Limits* postprocessing unit.



Fig. 2-24 The Math submenu.

The **Math** branch is used for modifying the measurement result mathematically before presentation on the display. Thus you can make the counter show directly what you want without tedious recalculations, e.g. revolutions/min instead of Hz.

The **Limits** branch is used for setting numerical limits and selecting the way the instrument will report the measurement results in relation to them.

Let us explore the **Math** submenu by pressing the corresponding softkey below the display.



Fig. 2-25 Selecting Math formula for postprocessing.

The display tells you that the Math function is not active, so press the **Math Off** key once to open the formula selection menu.

Select one of the five different formulas, where K, L and M are constants that the user can set to any value. X stands for the current non-modified measurement result.

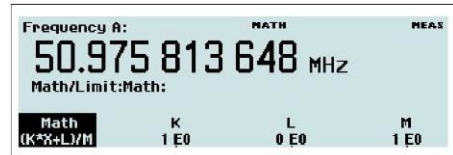

Fig. 2-26 Selecting formula constants.

Each of the softkeys below the constant labels opens a value input menu like the one below.



Fig. 2-27 Entering numeric values for constants.

Use the numeric input keys to enter the mantissa and the exponent, and use the EE key to toggle between the input fields. The key marked X₀ is used for entering the display reading as the value of the constant.

The **Limit** submenu is treated in a similar way, and its features are explored beginning on page 6-6.

■ User Options

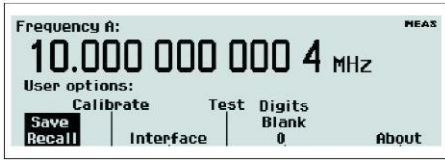

Fig. 2-28 CNT-90: The User Options menu.



Fig. 2-29 CNT-90XL & CNT-90 with Option 23/90: The User Options menu.

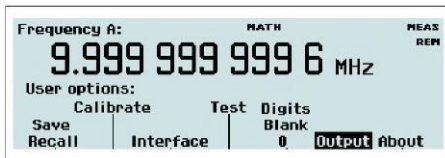

Fig. 2-30 CNT-91(R): The User Options menu.

From this menu you can reach a number of submenus that do not directly affect the measurement. You can choose between a number of modes by pressing the corresponding softkey.

Save/Recall Menu



Fig. 2-31 The menu appearance after pressing Save/Recall.

Twenty complete front panel setups can be stored in non-volatile memory. Access to the first ten memory positions is prohibited when *Setup Protect* is ON. Switching OFF *Setup Protect* releases all ten memory positions simultaneously.

The different setups can be individually labeled to make it easier for the operator to remember the application.



Fig. 2-32 The memory management menu after pressing Setup.

The following can be done:

- Save current setup



Fig. 2-33 Selecting memory position for saving a measurement setup.

Browse through the available memory positions by using the **RIGHT/LEFT** arrow keys. For faster browsing, press the key **Next** to skip to the next memory bank. Press the softkey below the number (1-20) where you want to save the setting.

- Recall setup



Fig. 2-34 Selecting memory position for recalling a measurement setup.

Select the memory position from which you want to retrieve the contents in the same way as under Save current setup above. You can also choose Default to restore the preprogrammed factory settings. See the table on page 2-19 for a complete list of these settings.

- Modify labels
Select a memory position to which you want to assign a label. See the descriptions under Save/Recall setup above. Now you can enter alphanumeric characters from the front panel. See the figure below.
The seven softkeys below the display are used for entering letters and digits in the same way as you write SMS messages on a cell phone.
- Setup protection
Toggle the softkey to switch between the **ON/OFF** modes. When **ON** is active, the memory positions 1-10 are all protected against accidental overwriting.



Fig. 2-35 Entering alphanumeric characters.

Dataset Menu

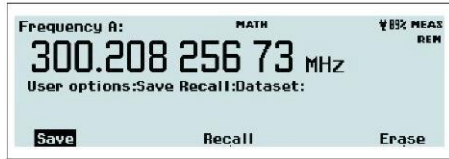

Fig. 2-36 The memory management menu after pressing Dataset.

This feature is available in statistics mode only, and if **HOLD** has been pressed prior to initiating a measurement with **RESTART**. Up to 8 different datasets can be saved in FLASH memory, each containing up to 32000 samples. If the pending measurement has more than 32000 samples, only the last 32000 will be saved. A default label will be assigned to the dataset. It can be changed in a similar way as the setup labels. See *Modify labels* above.

- Save
Select a memory position, accept or change the name, and press **OK**.
- Recall
Select a memory position and press **OK**.
- Total Reset
The safety screen below will appear. Pressing **OK** will restore all factory settings and erase all user information.

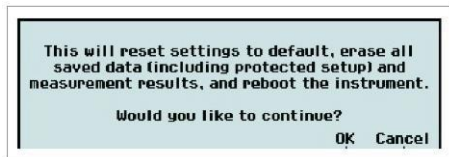

Fig. 2-37 The Total Reset safety screen.

Calibrate Menu

This menu entry is accessible only for calibration purposes and is password-protected.

Interface Menu

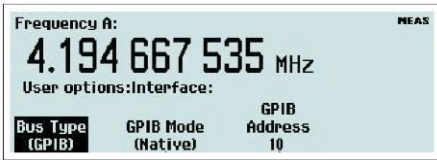

Fig. 2-38 Selecting active bus interface. Bus Type

Select the active bus interface. The alternatives are *GPIB* and *USB*. If you select *GPIB*, you are also supposed to select the *GPIB Mode* and the *GPIB Address*. See the next two paragraphs.

GPIB Mode

There are two command systems to choose from.

- **Native**
The SCPI command set used in this mode fully exploits all the features of this instrument series.
- **Compatible**
The SCPI command set used in this mode is adapted to be compatible with Agilent 53131/132/181.

GPIB Address

Value input menu for setting the GPIB address.

Test

A general self-test is always performed every time you power-up the instrument, but you can order a specific test from this menu at any time.

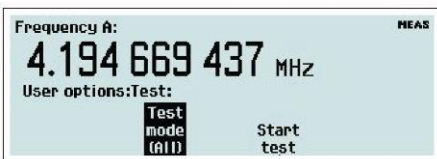

Fig. 2-39 Self-test menu.

Press **Test Mode** to open the menu with available choices.



Fig. 2-40 Selecting a specific test.

Select one of them and press **Start Test** to run it.

Digits Blank

Jittery measurement results can be made easier for an operator to read by masking one or more of the LSDs on the display.

Place the cursor at the submenu *Digits Blank* and increment/decrement the number by means of the **UP/DOWN** arrow keys, or press the soft key beneath the submenu and enter the desired number between 0 and 13 from the keyboard. The blanked digits will be represented by dashes on the display. The default value for the number of blanked digits is 0.

Misc (CNT-90XL & CNT-90 with Option 23/90)

The CNT-90XL without Option 23/90 has a single submenu called *Units*. By pressing this softkey you get to the submenu *Power*. Press *Power* and then select *dBm* or *W* as the unit of measurement, when either of the functions *Frequency C* or *Power C* is selected from the **MEAS FUNC** menu.

The CNT-90 with Option 23/90 has a single submenu called *Use Battery in Standby*. By toggling this softkey you can decide if the internal OCXO will remain powered or not when you turn off the instrument in battery operation mode.

The CNT-90XL with Option 23/90 has a combination of the two submenus mentioned above. See the figure below.

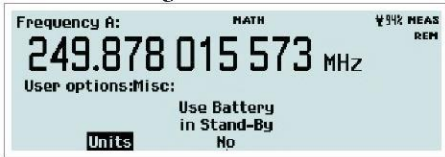

Fig. 2-41 The 'Misc' submenu for CNT-90XL with battery option.

Output [CNT-91(R) only]

The rear panel pulse output can be used for three different purposes:

- pulse generator
- gate indicator
- alarm

Press the softkey *Output* to open the submenu below.

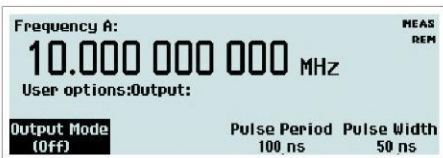

Fig. 2-42 Selecting output mode and pulse parameters.

Off is the default mode and inhibits all activity on the output connector.

The pulse generator parameters *Period* and *Width* can be entered by first pressing the corresponding softkeys, then setting the numerical values as usual. By placing the cursor over the parameter, you can also set the values directly in 1-2-5 steps with the **UP/DOWN** arrow keys.

Press *Output Mode* to enter the mode selection menu below:

- Gate Open indicates to external equipment when a measurement is in progress.

- Pulse Generator activates a continuous pulse train having the parameters entered in the previous menu.
- Alarm can be set to be active low or active high. The MATH/LIM menu is used for setting up the behavior and the numerical limits that trigger the alarm.

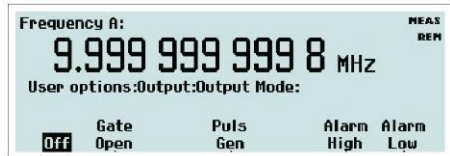

Fig 2-43 Output Mode selection menu.

The amplitude is fixed at TTL levels into $50\ \Omega$ irrespective of the output mode.

About

Here you can find information on:

- model
- serial number
- instrument firmware version
- timebase option & calibration date
 - The CNT-91R reports "Rubidium" in this field.
- RF input option
 - The CNT-90XL reports the upper frequency limit.

■ Hold/Run

This key serves the purpose of manual arming. A pending measurement will be finished and the result will remain on the display until a new measurement is triggered by pressing the **RESTART** key.

■ Restart

Often this key is operated in conjunction with the **HOLD/RUN** key (see above), but it can also be used in free-running mode, especially when long measuring times are being used, e.g. to initiate a new measurement after a change in the input signal. **RESTART** will not affect any front panel settings.

Default Settings

See page 2-16 to see how the following preprogrammed settings are recalled by a few keystrokes.

| PARAMETER | VALUE/SETTING |
|------------------------|---------------|
| Input A & B | |
| Trigger Level | AUTO |
| Trigger Slope | POS |
| Impedance | 1 M Ω |
| Attenuator | 1x |
| Coupling | AC |
| Filter | OFF |
| Arming | |
| Start | OFF |
| Start Slope | POS |
| Start Arm Delay | 0 |
| Stop | OFF |
| Stop Slope | POS |
| Hold-Off | |
| Hold-Off State | OFF |
| Hold-Off Time | 200 μ s |
| Time-Out | |
| Time-Out State | OFF |
| Time-Out Time | 100 ms |
| Statistics | |
| Statistics | OFF |
| No. of Samples | 100 |
| No. of Bins | 20 |
| Pacing State | OFF |
| Pacing Time | 20 ms |
| Mathematics | |
| Mathematics | OFF |

| PARAMETER | VALUE/SETTING |
|--------------------------|---------------|
| Math Constants | K=1, L=0, M=1 |
| Limits | |
| Limit State | OFF |
| Limit Mode | RANGE |
| Lower Limit | 0 |
| Upper Limit | 0 |
| Burst | |
| Sync Delay | 400 μ s |
| Start Delay | 0 |
| Meas. Time | 200 μ s |
| Freq. Limit | 400 MHz |
| Miscellaneous | |
| Function | FREQA |
| Smart Frequency | AUTO |
| Smart Time Interval | OFF |
| Meas. Time | 200 ms |
| Auto Trig Low Freq | 100 Hz |
| Timebase Reference | AUTO |
| Blank Digits | 0 |
| Interpolator calibration | ON |
| Output (CNT-91(R)) | OFF |

This page is intentionally left blank.

Chapter 3

Input Signal Conditioning

Input Amplifier

The input amplifiers are used for adapting the widely varying signals in the ambient world to the measuring logic of the timer/counter.

These amplifiers have many controls, and it is essential to understand how these controls work together and affect the signal.

The block diagram below shows the order in which the different controls are connected. It is not a complete technical diagram but in- tended to help understanding the controls.

The menus from which you can adjust the settings for the two main measurement channels are reached by pressing **INPUT A** respectively **INPUT B**. See Figure 3-2. The active choices are shown in boldface on the bottom line.



Fig. 3-2 Input settings menu.

Impedance

The input impedance can be set to 1 MΩ or 50 Ω by toggling the corresponding softkey.

CAUTION: Switching the impedance to 50 Ω when the input voltage is above 12 VRMS may cause permanent damage to the input circuitry.

Attenuation

The input signal's amplitude can be attenuated by 1 or 10 by toggling the softkey marked **1x/10x**.

Use attenuation whenever the input signal exceeds the dynamic input voltage range ±5 V or

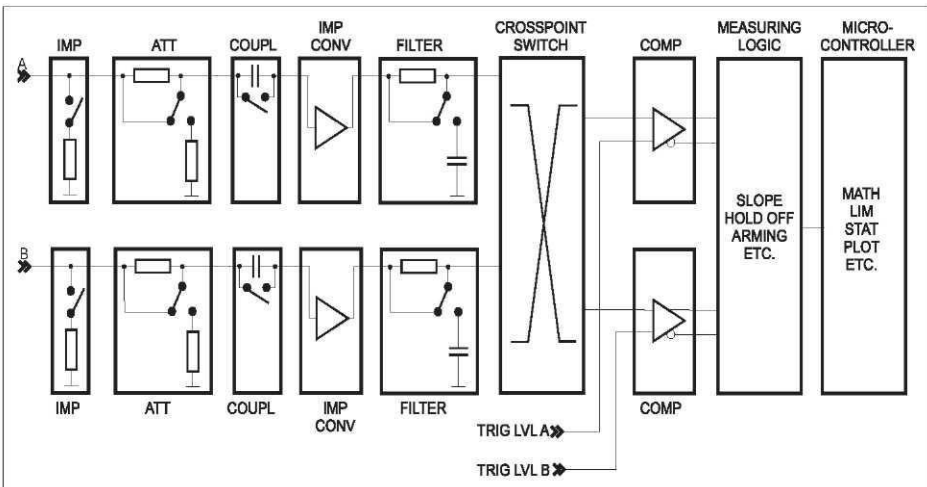

Fig. 3-1 Block diagram of the signal conditioning.

else when attenuation can reduce the influence of noise and interference. See the section dealing with these matters at the end of this chapter.

Coupling

Switch between AC coupling and DC coupling by toggling the softkey **AC/DC**.

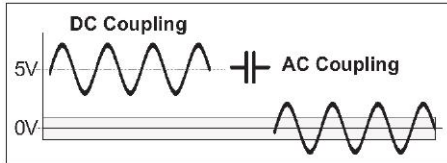

Fig. 3-3 AC coupling a symmetrical signal.

Use the AC coupling feature to eliminate unwanted DC signal components. Always use AC coupling when the AC signal is superimposed on a DC voltage that is higher than the trigger level setting range. However, we recommend AC coupling in many other measurement situations as well.

When you measure symmetrical signals, such as sine and square/triangle waves, AC coupling filters out all DC components. This means that a 0 V trigger level is always centered around the middle of the signal where triggering is most stable.

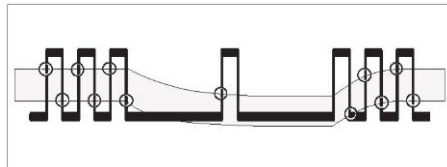

Fig. 3-4 Missing trigger events due to AC coupling of signal with varying duty cycle.

Signals with changing duty cycle or with a very low or high duty cycle do require DC coupling. Fig. 3-4 shows how pulses can be missed, while Fig. 3-5 shows that triggering

does not occur at all because the signal amplitude and the hysteresis band are not centered.

NOTE: For explanation of the hysteresis band, see page 4-3.

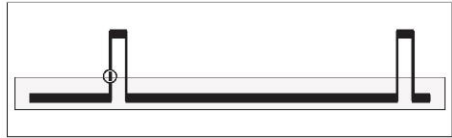

Fig. 3-5 No triggering due to AC coupling of signal with low duty cycle.

Filter

If you cannot obtain a stable reading, the signal-to-noise ratio (often designated S/N or SNR) might be too low, probably less than 6 to 10 dB. Then you should use a filter. Certain conditions call for special solutions like highpass, bandpass or notch filters, but usually the unwanted noise signals have higher frequency than the signal you are interested in. In that case you can utilize the built-in lowpass filters. There are both analog and digital filters, and they can also work together.



Fig. 3-6 The menu choices after selecting FILTER.

■ Analog Lowpass Filter

The counter has analog LP filters of RC type, one in each of the channels A and B, with a cutoff frequency of approximately 100 kHz, and a signal rejection of 20 dB at 1 MHz.

Accurate frequency measurements of noisy LF signals (up to 200 kHz) can be made when the noise components have significantly higher frequencies than the fundamental signal.

■ Digital Lowpass Filter

The digital LP filter utilizes the Hold-Off function described below.

With trigger Hold-Off it is possible to insert a deadtime in the input trigger circuit. This means that the input of the counter ignores all hysteresis band crossings by the input signal during a preset time after the first trigger event.

When you set the Hold-Off time to approx. 75% of the cycle time of the signal, erroneous triggering is inhibited around the point where the input signal returns through the hysteresis band. When the signal reaches the trigger point of the next cycle, the set Hold-Off time has elapsed and a new and correct trigger will be initiated.

Instead of letting you calculate a suitable Hold-Off time, the counter will do the job for you by converting the filter cutoff frequency you enter via the value input menu below to an equivalent Hold-Off time.



Fig. 3-7 Value input menu for setting the cutoff frequency of the digital filter.

You should be aware of a few limitations to be able to use the digital filter feature effectively and unambiguously. First you must have a rough idea of the frequency to be measured. A cutoff frequency that is too low might give a perfectly stable reading that is too low. In such a case, triggering occurs only on every 2nd, 3rd or 4th cycle. A cutoff frequency that is too

high (>2 times the input frequency) also leads to a stable reading. Here one noise pulse is counted for each half-cycle.

Use an oscilloscope for verification if you are in doubt about the frequency and waveform of your input signal.

The cutoff frequency setting range is very wide: 1 Hz - 50 MHz

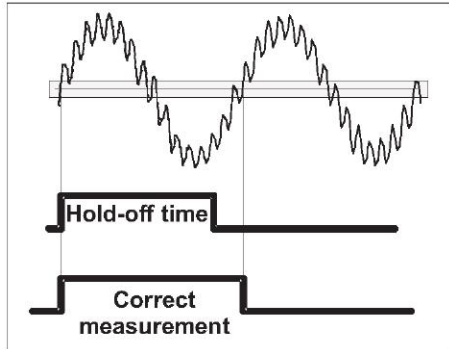

Fig. 3-8 Digital LP filter operates in the measuring logic, not in the input amplifier.

Man/Auto

Toggle between manual and automatic triggering with this softkey. When **Auto** is active the counter automatically measures the peak-to-peak levels of the input signal and sets the trigger level to 50% of that value. The attenuation is also set automatically.

At rise/fall time measurements the trigger levels are automatically set to 10% and 90% of the peak values.

When **Manual** is active the trigger level is set in the value input menu designated **Trig**. See below. The current value can be read on the display before entering the menu.

■ Speed

The Auto-function measures amplitude and calculates trigger level rapidly, but if you aim at higher measurement speed without having to sacrifice the benefits of automatic triggering, then use the **Auto Trig Low Freq** function to set the lower frequency limit for voltage measurement.

If you know that the signal you are interested in always has a frequency higher than a certain value f_{low} , then you can enter this value from a value input menu. The range for f_{low} is 1 Hz to 100 kHz, and the default value is 100 Hz. The higher value, the faster measurement speed due to more rapid trigger level voltage detection.

Even faster measurement speed can be reached by setting the trigger levels manually. See **Trig** below.

Follow the instructions here to change the low-frequency limit:

- Press **SETTINGS** → **Misc** → **Auto Trig Low Freq**.
- Use the **UP/DOWN** arrow keys or the numeric input keys to change the low frequency limit to be used during the trigger level calculation, (default 100 Hz).
- Confirm your choice and leave the **SETTINGS** menu by pressing **EXIT/OK** three times.

Trig

Value input menu for entering the trigger level manually.

Use the **UP/DOWN** arrow keys or the numeric input keys to set the trigger level.

A blinking underscore indicates the cursor position where the next digit will appear. The **LEFT** arrow key is used for correction, i.e. deleting the position preceding the current cursor position.



Fig. 3-9 Value input menu for setting the trigger level.

NOTE: It is probably easier to make small adjustments around a fixed value by using the arrow keys for incrementation or decrementation. Keep the keys depressed for faster response

NOTE: Switching over from AUTO to MAN Trigger Level is automatic if you enter a trigger level manually.

■ Auto Once

Converting "Auto" to "Fixed"

The trigger levels used by the auto trigger can be frozen and turned into fixed trigger levels simply by toggling the **MAN/AUTO** key. The current calculated trigger level that is visible on the display under **Trig** will be the new fixed manual level. Subsequent measurements will be considerably faster since the signal levels are no longer monitored by the instrument. You should not use this method if the signal levels are unstable.



NOTE: You can use auto trigger on one input and fixed trigger levels on the other.

How to Reduce or Ignore Noise and Interference

Sensitive counter input circuits are of course also sensitive to noise. By matching the signal amplitude to the counter's input sensitivity, you reduce the risk of erroneous counts from noise and interference. These could otherwise ruin a measurement.

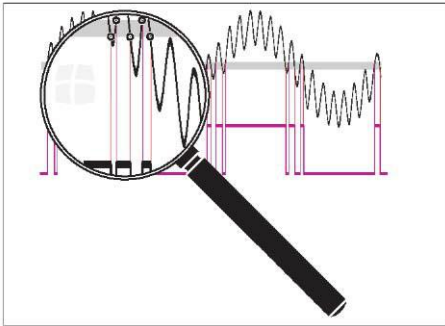

Fig. 3-10 Narrow hysteresis gives erroneous triggering on noisy signals.

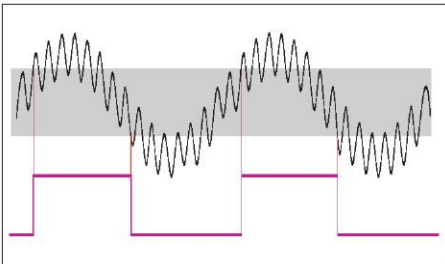

Fig. 3-11 Wide trigger hysteresis gives correct triggering.

To ensure reliable measuring results, the counter has the following functions to reduce or eliminate the effect of noise:

- 10x input attenuator
- Continuously variable trigger level
- Continuously variable hysteresis for some functions
- Analog low-pass noise suppression filter
- Digital low-pass filter (*Trigger Hold-Off*)

To make reliable measurements possible on very noisy signals, you may use several of the above features simultaneously.

Optimizing the input amplitude and the trigger level, using the attenuator and the trigger control, is independent of input frequency and useful over the entire frequency range. LP filters, on the other hand, function selectively over a limited frequency range.

Trigger Hysteresis

The signal needs to cross the 20 mV input hysteresis band before triggering occurs. This hysteresis prevents the input from self-oscillating and reduces its sensitivity to noise. Other names for trigger hysteresis are "trigger sensitivity" and "noise immunity". They explain the various characteristics of the hysteresis.

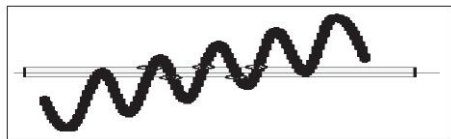

Fig. 3-12 Erroneous counts when noise passes hysteresis window.

Fig. 3-10 and Fig. 3-12 show how spurious signals can cause the input signal to cross the trigger or hysteresis window more than once per input cycle and give erroneous counts.

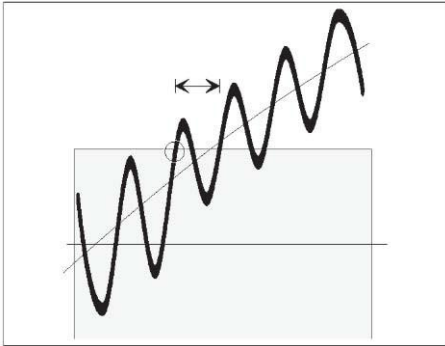

Fig. 3-13 Trigger uncertainty due to noise.

Fig. 3-13 shows that less noise still affects the trigger point by advancing or delaying it, but it does not cause erroneous counts. This trigger uncertainty is of particular importance when measuring low frequency signals, since the signal slew rate (in V/s) is low for LF signals. To reduce the trigger uncertainty, it is desirable to cross the hysteresis band as fast as possible.

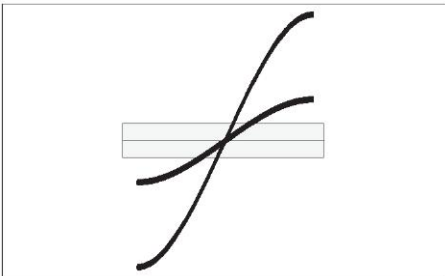

Fig. 3-14 Low amplitude delays the trigger point

Fig. 3-14 shows that a high amplitude signal passes the hysteresis faster than a low amplitude signal. For low frequency measurements where the trigger uncertainty is of importance, do not attenuate the signal too much, and set the sensitivity of the counter high.

In practice however, trigger errors caused by erroneous counts (Fig. 3-10 and Fig. 3-12) are much more important and require just the opposite measures to be taken.

To avoid erroneous counting caused by spurious signals, you need to avoid excessive input signal amplitudes. This is particularly valid when measuring on high impedance circuitry and when using 1 M Ω input impedance. Under these conditions, the cables easily pick up noise.

External attenuation and the internal 10x attenuator reduce the signal amplitude, including the noise, while the internal sensitivity control in the counter reduces the counter's sensitivity, including sensitivity to noise. Reduce excessive signal amplitudes with the 10x attenuator, or with an external coaxial attenuator, or a 10:1 probe.

How to use Trigger Level Setting

For most frequency measurements, the optimal triggering is obtained by positioning the mean trigger level at mid amplitude, using either a narrow or a wide hysteresis band, depending on the signal characteristics.

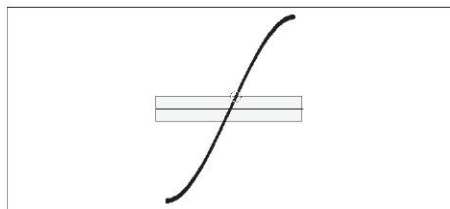

Fig. 3-15 Timing error due to slew rate.

When measuring LF sine wave signals with little noise, you may want to measure with a high sensitivity (narrow hysteresis band) to reduce the trigger uncertainty. Triggering at or

close to the middle of the signal leads to the smallest trigger (timing) error since the signal slope is steepest at the sine wave center, see Fig. 3-15.

When you have to avoid erroneous counts due to noisy signals, see Fig. 3-12, expanding the hysteresis window gives the best result if you still center the window around the middle of the input signal. The input signal excursions beyond the hysteresis band should be equally large.

■ Auto Trigger

For normal frequency measurements, i.e. without arming, the Auto Trigger function changes to *Auto (Wide) Hysteresis*, thus widening the hysteresis window to lie between 70 % and 30 % of the peak-to-peak amplitude. This is done with a successive approximation method, by which the signal's MIN. and MAX. levels are identified, i.e., the levels where triggering just stops. After this MIN./MAX. probing, the counter sets the trigger levels to the calculated values. The default relative trigger levels are indicated by 70 % on Input A and 30 % on Input B. These values can be manually adjusted between 50 % and 100 % on Input A and between 0 % and 50 % on Input B. The signal, however, is only applied to one channel.

Before each frequency measurement the counter repeats this signal probing to identify new MIN/MAX values. A prerequisite to enable AUTO triggering is therefore that the input signal is repetitive, i.e., >100 Hz (default). Another condition is that the signal amplitude does not change significantly after the measurement has started.

NOTE: AUTO trigger limits the maximum measuring rate when an automatic test system makes many measurements per second. Here you can increase the measuring rate by switching off this probing if the signal amplitude is constant. One single command

and the AUTO trigger function determines the trigger level once and enters it as a fixed trigger level.

■ Manual Trigger

Switching to **Man Trig** also means *Narrow Hysteresis* at the last Auto Level. Pressing **AUTOSET** once starts a single automatic trigger level calculation (*Auto Once*). This calculated value, 50 % of the peak-to-peak amplitude, will be the new fixed trigger level, from which you can make manual adjustments if need be.

■ Harmonic Distortion

As rule of thumb, stable readings are free from noise or interference.

However, stable readings are not necessarily correct; harmonic distortion can cause erroneous yet stable readings.

Sine wave signals with much harmonic distortion, see Fig. 3-17, can be measured correctly by shifting the trigger point to a suitable level or by using continuously variable sensitivity, see Fig. 3-16. You can also use Trigger Hold-Off, in case the measurement result is not in line with your expectations.

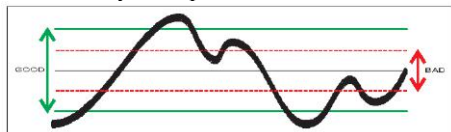

Fig. 3-16 Variable sensitivity.

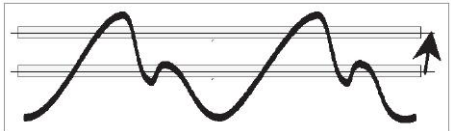

Fig. 3-17 Harmonic distortion.

Measuring Functions

Frequency Measurements

FREQ A, B

The counter measures frequency between 0 Hz and 400 MHz on Input A and Input B. The Auto Trig function operates from 1 Hz (default 100 Hz) to 300 MHz. The Manual Trig covers the whole frequency range

Frequencies above 100 Hz and up to 300 MHz are best measured using the *Default Setup*. See page 2-16. Then **Freq A** will be selected automatically. Other important automatic settings are **AC Coupling**, **Auto Trig** and **Meas Time 200 ms**. See below for an explanation. You are now ready to start using the most common function with a fair chance to get a result without further adjustments

Summary of Settings for Good Frequency Measurements

- *AC Coupling*, because possible DC offset is normally undesirable.
- *Auto Trig* means *Auto Hysteresis* in this case, (comparable to AGC) because superimposed noise exceeding the normal narrow hysteresis window will be suppressed.
- *Meas Time 200 ms* to get a reasonable tradeoff between measurement speed and resolution.

Some of the settings made above by recalling the *Default Setup* can also be made by activating the **AUTOSET** key. Pressing it once means:

- *Auto Trig*. Note that this setting will be made once only if *Man Trig* has been selected earlier.

Pressing **AUTOSET** twice within two seconds also adds the following setting:

- *Meas Time 200 ms*.

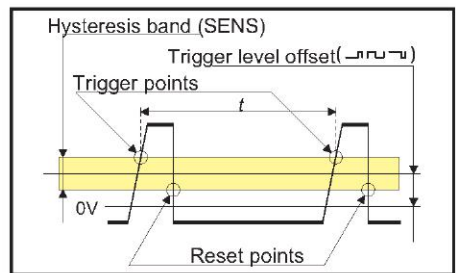

Fig. 4-1 Frequency is measured as the inverse of the time between one trigger point and the next;

$$f = \frac{1}{t}$$

FREQ C

CNT-90/91(R)

With an optional prescaler the counter can measure up to 3, 8, 15 or 20 GHz on Input C. These RF inputs are fully automatic and no setup is required.

CNT-90XL

The four versions cover the frequency ranges 27, 40, 46 and 60 GHz by means of an automatic down-conversion technique described on page 4-12. Faster (manual) acquisition is an alternative if the measured frequency is fairly known. Then its nominal value can be entered via the keyboard as a fixed starting point for the acquisition process.

Note: Some frequencies may not be acquired correctly with Auto Acquisition. If so, switch to Manual Acquisition instead.

An additional feature is the possibility to measure signal power with high resolution.

RATIOA/B, B/A, C/A, C/B

To find the ratio between two input frequencies, the counter counts the cycles on two channels simultaneously and divides the result on the primary channel by the result on the secondary channel.

Ratio can be measured between Input A and Input B, where either channel can be the primary or the secondary channel. Ratio can also be measured between Input C and Input A or between Input C and Input B. Here Input C is the primary channel.



Note that the resolution calculations are very different as compared to frequency measurements. See page 8-55 for details.

BURST A, B, C

A burst signal as in Fig. 4-2 has a carrier wave (CW) frequency and a modulation frequency, also called the pulse repetition frequency (PRF), that switches the CW signal on and off.

Both the CW frequency, the PRF, and the number of cycles in a burst are measured without external arming signals and with or without selectable start arming delay. See Chapter 5 "Measurement Control" for a fundamental discussion of arming and arming delay.

The general frequency limitations for the respective measuring channel also apply to burst measurements. The minimum number of cycles in a burst on Input A or Input B is 3 below 160 MHz and 6 between 160 MHz and 400 MHz (using Manual Trigger). Burst measurements on Input C involve prescaling, so the minimum number of cycles will be $3 \times$ *prescaling factor*. The 3 GHz option, for example, has a prescaling factor of 16 and requires at least 48 cycles in each burst.

The minimum burst duration is 40 ns below and 80 ns above 160 MHz.

Triggering

Bursts with a PRF above 50 Hz can be measured with auto triggering on.

The out-of-sync error described under heading "Possible errors" on page 4-6 may occur more frequently when using *Auto Trigger*.

When PRF is below 50 Hz and when the gap between the bursts is very small, use manual triggering.

Always try using **AUTOSET** first. Then the *Auto Trigger* and the *Auto Sync* functions in combination will give satisfactory results without further tweaking in most cases. Sometimes switching from **AUTO** to **MANUAL** triggering in the **INPUT A/B** menus is enough to get stable readings. The continually calculated trigger levels will then be fixed.

Input C has always automatic triggering and **AUTOSET** only affects the burst synchronization.

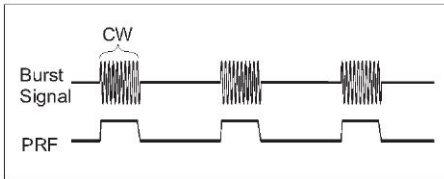

Fig. 4-2 Burst signal.

Burst Measurements using Manual Presetting

You can measure the frequency on Input A and Input B to 400 MHz and on Input C with limited specifications to the upper frequency limit of the prescaler with the internally synchronized BURST function as follows:

- Select **Freq Burst** under the **Freq** menu
- Select **A, B,** or **C** as measurement input.
- Press **SETTINGS** and **Burst**. Select a **Meas Time** that is shorter than the burst duration minus two CW cycles.

If you do not know the approximate burst parameters of your signal, always start with a short measurement time and increase it gradually until the readout gets unstable.

- Press **Sync Delay** and enter a value longer than the burst duration and shorter than the inverse of the PRF. See Fig. 4-3.

- Press **Start Delay** and enter a value longer than the transient part of the burst pulse.
- Select **Frequency Limit** (160/400 MHz) if

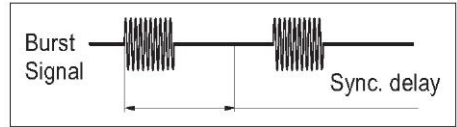

Fig. 4-3 Set the sync delay so that it expires in the gap between the bursts.

Use the low limit if possible to minimize the number of cycles necessary to make a measurement.

- Press **EXIT/OK** to measure.

All relevant burst parameters can be read on the display simultaneously.

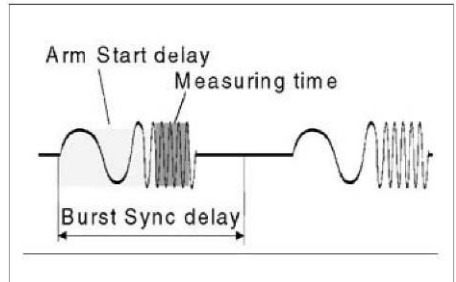

Fig. 4-4 Three time values must be set to measure the correct part of a burst

■ Selecting Measurement Time

The measurement time must be shorter than the duration of the burst. If the measurement continues during part of the burst gap, no matter how small a period of time, then the measurement is ruined. Choosing a measurement time that is too short is better since it only reduces the resolution. Making burst frequency measurements on short bursts means using short measurement times, giving a poorer resolution than normally achieved with the counter.

■ How Does the Sync Delay Work?

The sync delay works as an internal start arming delay: it prevents the start of a new measurement until the set sync delay has expired. See Fig. 4-5.

After the set measurement time has started, the counter synchronizes the start of the measurement with the second trigger event in the burst. This means that the measurement does not start erroneously during the Burst Off duration or inside the burst.

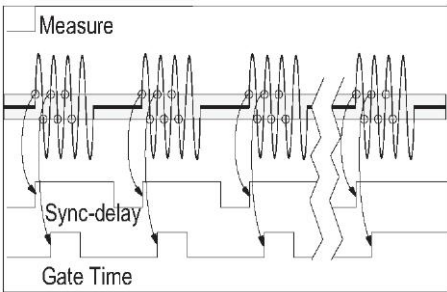

Fig. 4-5 Measuring the frequency of the carrier wave signal in a burst.

■ Possible Errors

Before the measurement has been synchronized with the burst signal, the first measurement(s) could start accidentally during the presence of a burst. If this would happen and if the remaining burst duration is shorter than the set measurement time, the readout of the first measurement will be wrong. However, after this first measurement, a properly set start-arming sync delay time will synchronize the next measurements.

In manually operated applications, this is not a problem. In automated test systems where the result of a single measurement sample must be reliable, at least two measurements must be made, the first to synchronize the measurement and the second from which the measurement result can be read out.

Frequency Modulated Signals

A frequency modulated signal is a carrier wave signal (CW frequency = f_0) that changes in frequency to values higher and lower than the frequency f_0 . It is the modulation signal that changes the frequency of the carrier wave.

The counter can measure:

f_0 = Carrier frequency.

f_{max} = Maximum frequency.

f_{min} = Minimum frequency.

Δf = Frequency swing = $f_{max} - f_0$.

Carrier Wave Frequency f_0

To determine the carrier wave frequency measure f_{mean} which is a close approximator of f_0 .

Press **STAT/PLOT** to get an overview of all the statistical parameters.

Select the measurement time so that the counter measures an integral number of modulation periods. This way the positive frequency deviations will compensate the negative deviations during the measurement.

Example: If the modulation frequency is 50 Hz, the measurement time 200 ms will make the counter measure 10 complete modulation cycles.

If the modulation is non-continuous, like a voice signal, it is not possible to fully compensate positive deviations with negative deviations. Here, part of a modulation swing may remain uncompensated for, and lead to a

measuring result that is too high or too low.

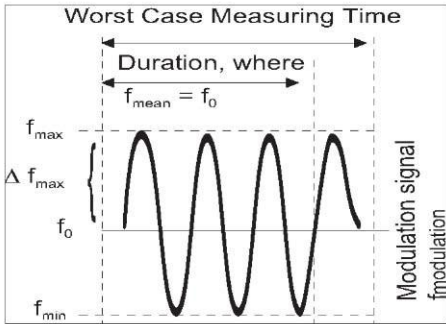

Fig. 4-6 Frequency modulation

In the worst case, exactly half a modulation cycle would be uncompensated for, giving a maximum uncertainty of:

$$f_0 - f_{mean} = \frac{\Delta f_{max}}{t_{measuring} \times f_{modulation} \times \pi}$$

For very accurate measurements of the carrier wave frequency f_0 , measure on the unmodulated signal if it is accessible.

■ **Modulation Frequencies above 1 kHz**

- Turn off **SINGLE**.
- Set a long measurement time that is an even multiple of the inverse of the modulation frequency.

You will obtain a good approximation when you select a long measurement time, for instance 10 s, and when the modulation frequency is high, above 1000 Hz.

■ **Low Modulation Frequencies**

Press **SETTINGS** → **STAT** and make the **No. of samples** parameter as large as possible considering the maximum allowed measurement time. Press **STAT/PLOT** and let the counter calculate the mean value of the samples.

You will usually get good results with 0.1 s measurement time per sample and more than 30 samples ($n \geq 30$). You can try out the optimal combination of sample size and measurement time for specific cases. It depends on the actual f_0 and Δf_{max} .

Here the sampling frequency of the measurement ($1/\text{measurement time}$) is asynchronous with the modulation frequency. This leads to individual measurement results which are randomly higher and lower than f_0 . The statistically averaged value of the frequency f_{mean} approaches f_0 when the number of averaged samples is sufficiently large.

When the counter measures instantaneous frequency values (when you select a very short measurement time), the RMS measurement uncertainty of the measured value of f_0 is:

$$f_0 - f_{mean} = \pm \frac{1}{\sqrt{2n}} \times \Delta f_{max}$$

where n is the number of averaged samples of f .

f_{max}

- Press **SETTINGS** → **STAT** and set **No. of samples** to 1000 or more.
- Press **Meas Time** and select a low value.
- Press **STAT/PLOT** and watch f_{max} .

f_{min}

- Press **SETTINGS** → **STAT** and set **No. of samples** to 1000 or more.
- Press **Meas Time** and select a low value.
- Press **STAT/PLOT** and watch f_{min} .

Δf_{p-p}

- Press **SETTINGS** → **STAT** and set **No.of samples** to 1000 or more.
- Press **Meas Time** and select a low value.
- Press **STAT/PLOT** and watch Δf_{p-p} .

$$\Delta f_{p-p} = f_{max} - f_{min} = 2 \times \Delta f.$$

Errors in f_{max} , f_{min} , and Δf_{p-p}

A measurement time corresponding to 1/10 cycle, or 36° of the modulation signal, leads to an error of approx. 1.5%.

Select the measurement time:

$$t_{measure} \leq \frac{1}{10 \times f_{modulation}}$$

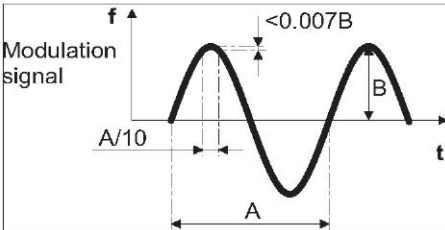

Fig. 4-7 Error when determining f_{max}

To be confident that the captured maximal frequency really is f_{max} , you must select a sufficiently large number of samples, for instance $n \geq 1000$.

AM Signals

The counter can usually measure both the carrier wave frequency and modulation frequency of AM signals. These measurements are much

like the burst measurements described earlier in this manual.

Carrier Wave Frequency

The carrier wave (CW) is only continuously present in a narrow amplitude band in the middle of the signal if the modulation depth is high. If the sensitivity of the counter is too low, cycles will be lost, and the measurement ruined.

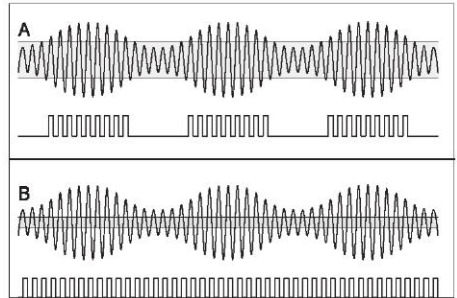

Fig. 4-8 Effects of different sensitivity when measuring the CW Frequency of an AM signal.

To measure the CW frequency:

- Enter the **INPUT A** menu.
- Select a measurement time that gives you the resolution you want.
- Turn on **Manual** trigger.
- Press **Trig** level and enter 0 V trigger level (press the numeric key **0** and **EXIT/OK**).
- Select **AC** coupling.
- Select **1x** attenuation to get a narrow hysteresis band.
- If the counter triggers on noise, widen the hysteresis band with the 'variable hysteresis' function, i.e. enter a trigger level >0 V but $<V_{p-pmin}$. See Fig. 4-8.

Modulating Frequency

The easiest way to measure the modulating frequency is after demodulation, for instance by means of a so-called RF-detector probe (also known as a demodulator probe, e.g. Pomona type 5815) used with AC-coupling of the input channel. If no suitable demodulator is available, use the **Freq Burst** function to measure the modulation frequency in the same way as when measuring **Burst PRF**.

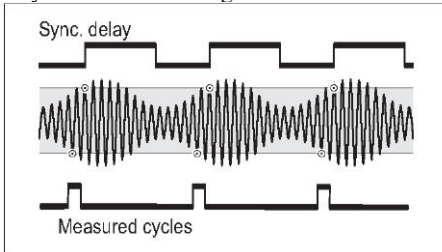

Fig. 4-9 Measuring the modulating frequency.

- Press **MEAS FUNC** and select **Freq Burst A**.
- Press **SETTINGS** → **Burst** → **Meas Time** and enter a measurement time that is approximately 25 % of the modulating period.
- Press **Sync Delay** and enter a value that is approximately 75 % of the modulating period. See Fig. 4-3.
- Press **INPUT A** and turn on **Manual trigger**.
- Press **Trig** and enter a trigger level that makes the counter trigger according to Fig. 4-9.

Even though the main frequency reading may now be unstable, the PRF value on the display will represent the modulating frequency.

Theory of Measurement

Reciprocal Counting

Simple frequency counters count the number of input cycles during a preset gate time, for instance one second. This leads to a ± 1 input cycle count error that, at least for low-frequency measurements, is a major contribution to uncertainty.

However, the counters described here use a high-resolution, reciprocal counting technique, synchronizing the measurement start with the input signal. In this way an exact number of integral input cycles will be counted, thereby omitting the ± 1 input cycle error.

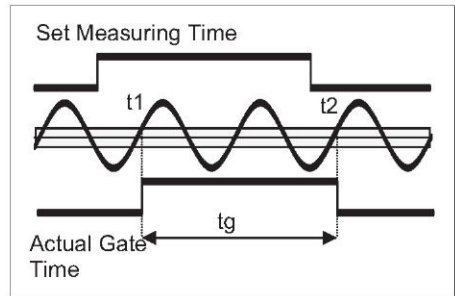

Fig. 4-10 Synchronization of a measurement.

After the start of the set measurement time, the counter synchronizes the beginning of the actual gate time with the first trigger event (t_1) of the input signal. See also Fig. 4-10.

In the same way, the counter synchronizes the stop of the actual gate time with the input signal, after the set measurement time has elapsed. The multi-register counting technique allows you to simultaneously

measure the actual gate time (t_g) and the number of cycles (n) that occurred during this gate time.

Thereafter, the counter calculates the frequency according to Mr. Hertz's definition:

$$f = \frac{n}{t_g}$$

The '9X' measures the gate time, t_g , with a resolution of 100 ps, independent of the measured frequency. Consequently the use of prescalers does not influence the quantization error. Therefore, the *relative* quantization error is: 100 ps/ t_g .

For a 1-second measurement time, this value is:

$$\frac{100 \text{ ps}}{1 \text{ s}} = 100 \times 10^{-12} = 1 \times 10^{-10}$$

Except for very low frequencies, t_g and the set measurement time are nearly identical.

Sample-Hold

If the input signal disappears during the measurement, the counter will behave like a voltmeter with a sample-and-hold feature and will freeze the result of the previous measurement.

Time-Out

Mainly for GPIB use, you can manually select a fixed time-out in the menu reached by pressing **SETTINGS** → **Misc** → **Timeout**. The range of the fixed time-out is 10 ms to 1000 s, and the default setting is **Off**.

Select a time that is longer than the cycle time of the lowest frequency you are going to measure; multiply the time by the prescaling factor of the input channel and enter that time as time-out.

When no triggering has occurred during the time-out, the counter will show **NO SIGNAL**.

Measuring Speed

The set measurement time determines the measuring speed for those functions that utilize averaging - **Frequency** and **Period Avg.** For continuous signals,

$$Speed \approx \frac{1}{t_g + 0.2} \text{ readings/s when Auto}$$

trigger is on and can be increased to:

$$Speed \approx \frac{1}{t_g + 0.001} \text{ readings/s}$$

when **Manual** trigger is on, or via GPIB:

$$Speed \approx \frac{1}{t_g + 0.00012} \text{ readings/s}$$

■ Average and Single Cycle Measurements

To reduce the actual gate time or measuring aperture, the counters have very short measurement times and a mode called **Single** for period measurements. The latter means that the counter measures during *only one cycle* of the input signal. In applications where the counter uses an input channel with a prescaler, the **Single** measurement will last as many cycles as the division factor. If you want to measure with a very short aperture, use an input with a low division factor.

Averaging is the normal mode for frequency and period measurements when you want to reach maximum resolution. There is always a tradeoff between time and precision, however, so decide how many digits you need and use as short a measurement time as possible to arrive at your objective.

■ **CNT-90/91(R): Prescaling May Influence Measurement Time**

Prescalers do affect the minimum measurement time, inasmuch as short bursts have to contain a minimum number of carrier wave periods. This number depends on the prescaling factor.

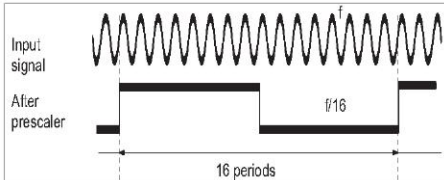

Fig. 4-11 Divide-by-16 Prescaler.

Fig. 4-11 shows the effect of the 3 GHz prescaler. For 16 input cycles, the prescaler gives one square wave output cycle. When the counter uses a prescaler, it counts the number of prescaled output cycles, here $f/16$. The display shows the correct input frequency since the microcomputer compensates for the effect of the division factor d as follows:

$$f = \frac{n \times d}{t_g}$$

Prescalers do not reduce resolution in reciprocal counters. The relative quantization error is still:

$$\frac{100 \text{ ps}}{t_g}$$

See Table 4-1 to find the prescaling factors used in different operating modes.

■ **LF Signals**

Signals below 100 Hz should be measured with manual triggering, unless the default setting (100 Hz) is changed. See page 2-13. The low limit can be set to 1 Hz, but the measurement process will be slowed down considerably if auto triggering is used in conjunction with very low frequencies.

| Function | Prescaling Factor |
|--------------------------|-------------------|
| FREQ A/B (400 MHz) | 2 |
| BURST A/B (<160MHz) | 1 |
| BURST A/B (>160MHz) | 2 |
| PERIOD A/B AVG (400 MHz) | 2 |
| PERIOD A/B SGL (400 MHz) | 1 |
| FREQ C (3 GHz) | 16 |
| FREQ C (8 GHz) | 256 |
| FREQ C (15 & 20 GHz) | 128 |
| All other functions | 1 |

Table 4-1 Prescaling factors.

When measuring pulses with a low repetition rate, for example a 0.1 Hz pulse with a non-prescaled function like PERIOD SGL, the measurement will require at least the duration of one cycle, that is 10 seconds, and at worst nearly 20 seconds. The worst case is when a trigger event took place just before the beginning of a measurement time (Fig. 4-12). Measuring the frequency of the same signal will take twice as long, since this function involves prescaling by a factor two.

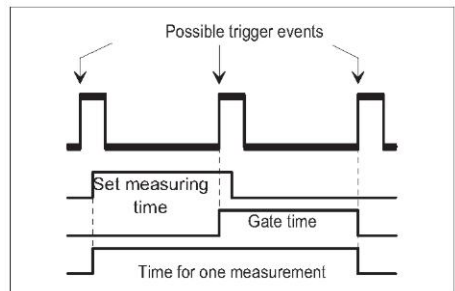

Fig. 4-12 Measurement Time.

Even if you have chosen a short measurement time, this measurement will require between 20 and 40 seconds (for this example).

■ **CNT-90/91(R): RF Signals**

As mentioned before, a prescaler in the C-in-put divides the input frequency before it is counted by the normal digital counting logic. The division factor is called *prescaler factor* and can have different values depending on the prescaler type. The 3 GHz prescaler is designed for a prescaling factor of 16. This means that an input C frequency of, e.g., 1.024 GHz is transformed to 64 MHz.

Prescalers are designed for optimum performance when measuring stable continuous RF. Most prescalers are inherently unstable and would self-oscillate without an input signal. To prevent a prescaler from oscillating, a "go-detector" is incorporated. See Fig. 4-13.

The go-detector continuously measures the level of the input signal and simply blocks the prescaler output when no signal, or a signal that is too weak, is present.

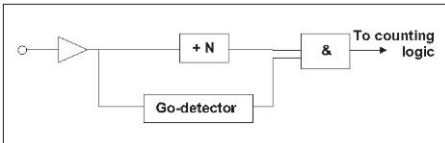

Fig. 4-13 Go-detector in the prescaler.

The presence of a burst signal to be measured makes certain demands upon the signal itself. Regardless of the basic counter's ability to measure during very short measurement times, the burst duration must meet the following minimum conditions:

$$Burst_{min} > (presc. factor) \times (inp. cycle time) \times 3$$

or at least 80 ns

Normally the real minimum limit is set by other factors, like the speed of the GO-detector. This speed depends on the specific input option used.

■ **CNT-90XL: Microwave Conversion**

Measuring frequencies up to 20 GHz is possible with the top-performance prescaler option 14B. The general principles of prescalers are described in the preceding paragraph.

The different versions of the CNT-90XL are intended for applications with upper frequency limits between 27 GHz and 60 GHz.

Here another technique is utilized, down conversion by means of mixing the unknown signal with known LO frequencies until there is a signal present within the passband of the IF amplifier, in this case 10 - 200 MHz.

A simplified block diagram can be seen in Fig. 4-14.

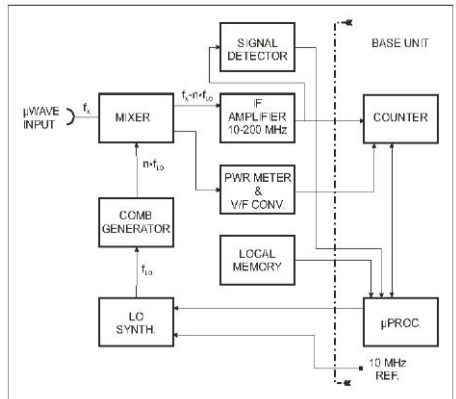

Fig. 4-14 Microwave acquisition in the CNT-90XL.

The basic LO frequency range is 430 - 550 MHz and is divided into a number of discrete frequencies fetched from a look-up table. The LO output is fed to a comb generator that creates a harmonic spectrum covering the whole specified microwave range.

The automatic process of calculating the input frequency consists of the following steps:

— *Preacquisition*

The purpose of this process is to find out if there is a measurable signal present at the input, and if so, fix the LO frequency that gives rise to an IF signal above a certain threshold level. This is done by sequentially stepping the LO from the highest value in the look-up table to the lowest value and applying the resulting comb generator spectrum to the mixer. The process is stopped when the signal detector outputs a status signal to the processor.

— *Acquisition*

We don't know yet which harmonic generates the IF signal. First we measure the IF with the counter. Then we decrease the LO frequency by 1 MHz and measure the IF once more. If, for instance, the difference between the two values is 5 MHz, then we know that the fifth harmonic is the origin. By examining the sign of the difference, we can decide if the original IF should be added to or subtracted from the calculated harmonic in order to arrive at the final value.

— *Final RF calculation*

Now we know the LO frequency, the multiplication factor 'n' and the sign. What remains to be done is to count the IF during a measurement time corresponding to the desired resolution, and then the result is used for calculating the final value to be presented on the display as: $f_x = n \times f_{LO} \pm IF$

There are a number of conditions that can complicate the acquisition process. All of them are handled by measures taken by the instrument firmware. Two examples:

- One of the step frequencies produces an IF but not its shifted value. Action: go to the next table value.

- Frequency modulation causes an unstable 'n' value calculation. Action: increase the measuring time.

Power measurement

Another feature in this instrument is the ability to measure power with high resolution and moderate accuracy over the entire frequency range, achieved by storing individual frequency dependent power correction factors in a memory located inside the conversion unit. This memory is also used for storing other information about the converter like identification data.

PERIOD

Single A, B & Avg. A, B, C

From a measuring point of view, the period function is identical to the frequency function. This is because the period of a cyclic signal has the reciprocal value of the frequency (1/f).

In practice there are two minor differences.

1. The counter calculates FREQUENCY (always AVG) as:

$$f = \frac{\text{numberofcycles}}{\text{actual gate time}}$$

while it calculates PERIOD AVG as:

$$p = \frac{\text{actualgatetime}}{\text{number of cycles}}$$

2. In the PERIOD SINGLE mode, the counter uses no prescaler.

All other functions and features as described earlier under "Frequency" apply to Period measurements as well.

Single A, B Back-to-Back

■ CNT-91(R) only

This function benefits from the basic time-stamping calculation method utilized by this series of counters to obtain consecutive measurement results without dead time.

Every positive or negative zero crossing (depending on the selected slope) up to the maximum frequency (125 kHz with interpolator calibration **ON** or 250 kHz with interpolator calibration **OFF**) is time-stamped. For every new time stamp the previous value is subtracted from the current value and displayed.

In **VALUES** mode the display is updated every new period if the period time exceeds 200 ms. For shorter times every second, third etc. result is displayed due to the limited updating rate.

In **STATISTICS** mode the graphs and statistical data contain all periods up to the maximum input frequency (see above). For higher frequencies the average period time during the 4 or 8 μ s observation time is displayed. So, for higher frequencies the actual function is rather *Period Average Back-to-Back*.

The main purpose of this function is to make continuous measurements of relatively long period times without losing single periods due to result processing. A typical example is the 1-pps timebase output from GPS receivers.

Frequency A, B Back-to-Back

■ CNT-91(R) only

This is the inverse function of Period Back-to-Back. In **STATISTICS** mode *measurement time* is used for pacing the time stamps. The *pacing* parameter is not used in this case.

Thus a series of consecutive frequency average measurements without dead time can be made in order to fulfil the requirements for correct calculation of Allan variance or deviation. These statistical measures are, for instance, widely used by oscillator manufacturers to describe short-term stability.

Time Measurements

Introduction

Measuring the time between a start and a stop condition on two separate channels is the basis for all time interval measurements. In addition to the fundamental function **Time Interval A to B**, the counters also offer other channel combinations and derived functions like **Pulse Width** and **Rise/Fall Time**.

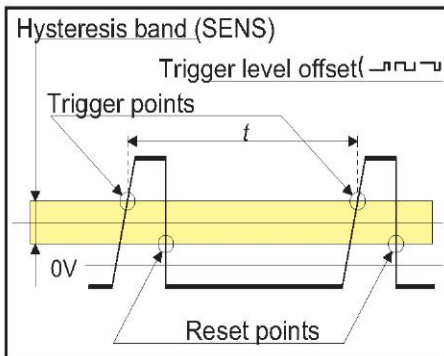

Fig. 4-15 Time is measured between the trigger point and the reset point. Accurate measurements are possible only if the hysteresis band is narrow.

Triggering

The set trigger level and trigger slope define the start and stop triggering.

If **Auto** is on, the counter sets the trigger level to 50% of the signal amplitude, which is ideal for most time measurements.

■ Summary of Conditions for Reliable Time Measurements:



- **Auto Once**, that is freezing the levels determined by **Auto Trig**, is normally the best choice when making time measurements. Choose **Man Trig** and press **AUTOSET** once.
- **DC** coupling.
- **1x** Attenuation. Selected automatically if **AUTOSET** was used before to set the trigger levels.
- High signal level.
- Steep signal edges.

Even though the input amplifiers have high sensitivity, the hysteresis band has a finite value that would introduce a small timing error for signals with different rise and fall times, for instance asymmetrical pulse signals like the one in Fig. 4-15. This timing error is taken care of by using hysteresis compensation

that virtually moves the trigger points by half the hysteresis band.

Time Interval

All time interval functions can be found under the function menu **Time**.

The toggling **SLOPE** keys (marked with a positive  or negative  edge symbol) under the menus **INPUT A/B** decide which edge of the signal will start resp. stop the measurement.

Time Interval A to B

The counter measures the time between a start condition on input A and a stop condition on input B.

Time Interval B to A

The counter measures the time between a start condition on input B and a stop condition on input A.

Time Interval A to A, B to B

When the same (common) signal source supplies both start and stop trigger events, connect the signal to either input A or input B.

These functions can be used for measuring rise and fall times between arbitrary trigger levels.

CNT-91(R): Time Interval Error (TIE)

This function can be found under the function menu **Time** and is only applicable to clock signals, not data signals.

TIE measurement uses continuous time-stamping to observe slow phase shifts (wander) in nominally stable signals during extended periods of time. Monitoring distributed PLL clocks in synchronous data transmission systems is a typical application.

The frequency of the signal to be checked can be either manually or automatically set. **Auto** detects the frequency from the first two samples. The value is rounded to four digits, e.g. 2.048 MHz and is output on the bus when a query is sent. It is also displayed as an auxiliary parameter in **VALUE** mode.

TIE is measured as the time interval between the input signal and the internal or external timebase clock. These signals are not phase-locked, so irrespective of the real time interval value at the start of a measurement, the result at $t = 0$ is mathematically nulled. Thus the graphic representation in **STATIS-TICS** mode starts at the origin of coordinates.

Rise/Fall Time A/B

These functions can be found under the function menu **Time**.

Rise and fall time can be measured on both input A and input B.

By convention, rise/fall time measurements are made with the trigger levels set to 10 % (start) and 90 % (stop) of the maximum pulse amplitude, see Figure 4-16.

The counter measures the time from when the signal passes 10 % of its amplitude to when it passes 90 % of its amplitude. The trigger levels are calculated and set automatically.

Auxiliary parameters shown simultaneously are Slew Rate (V/s), V_{max} and V_{min}

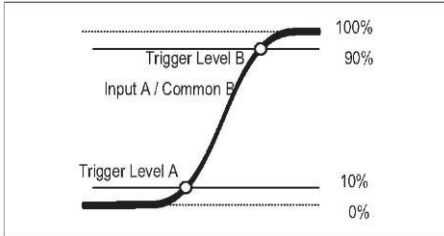

Fig. 4-16 Trigger levels for rise/fall measurements.

For ECL circuits, the reference levels are 20 % (start) and 80 % (stop). In this case you can use either of two methods:

1. Select the general *Time Interval* function described above and set the trigger levels manually after calculating them from the absolute peak values. Then you can benefit from the auxiliary parameters V_{max} and V_{min} . For measurements made on input A, use the following settings:

Rise

Time:

$$\text{Trig Level A} = V_{min} + 0.2(V_{max} - V_{min})$$

$$\text{Trig Level B} = V_{min} + 0.8(V_{max} - V_{min})$$

Fall Time:

$$\text{Trig Level A} = V_{min} + 0.8(V_{max} - V_{min})$$

$$\text{Trig Level B} = V_{min} + 0.2(V_{max} - V_{min})$$

2. Select one of the dedicated *Rise/Fall Time* functions, and exploit the possibility to manually adjust the relative trigger levels (in %) when *Auto Trigger* is active. Both input channel menus are used for entering the levels, but only one channel is the active signal input.

See the paragraph on *Auto Trigger* (page 4-19) to find out how overshoot or ringing may affect your measurement.

Pulse Width A/B

The function menu designation is **Pulse**.

Either input A or input B can be used for measuring, and both positive and negative pulse width can be selected.

- Positive pulse width means the time between a rising edge and the next falling edge.
- Negative pulse width means the time between a falling edge and the next rising edge.

The selected trigger slope is the start trigger slope. The counter automatically selects the inverse polarity as stop slope.

Duty Factor A/B

The function menu designation is **Pulse**.

Either input A or input B can be used for measuring, and both positive and negative duty factor can be selected. See the preceding paragraph for a definition of *positive* and *negative* in this context.

Duty factor (or duty cycle) is the ratio between pulse width and period time. The counter determines this ratio by first making a pulse width measurement, then a period measurement, and calculates the duty factor as:

$$\text{Duty factor} = \frac{\text{Pulsewidth}}{\text{Period}}$$



The total measurement time will be doubled compared to a single measurement, because "Duty" requires 2 measurement steps.

Measurement Errors

Hysteresis

The trigger hysteresis, among other things, causes measuring errors, see Figure 4-17. Actual triggering does not occur when the input signal crosses the trigger level at 50 percent of the amplitude, but when the input signal has crossed the entire hysteresis band.

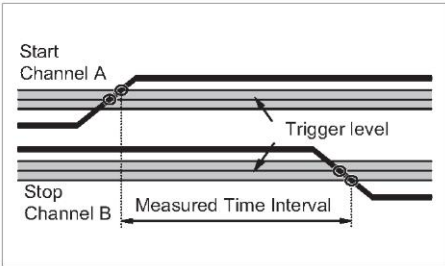

Fig. 4-17 Trigger hysteresis

The hysteresis band is about 20 mV with attenuation **1x**, and 200 mV with attenuation **10x**.

To keep this hysteresis trigger error low, the attenuator setting should be **1x** when possible. Use the **10x** position only when input signals have excessively large amplitudes, or when you need to set trigger levels higher than 5 V.

Overdrive and Pulse Rounding

Additional timing errors may be caused by triggering with insufficient overdrive, see Figure 4-18. When triggering occurs too close to the maximum voltage of a pulse, two phenomena may influence your measurement uncertainty: overdrive and rounding.

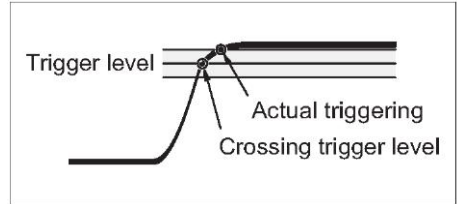

Fig. 4-18 Insufficient overdrive causes Trigger Error.

Overdrive: When the input signal crosses the hysteresis band with only a marginal overdrive, triggering may take some 100 ps longer than usual. The specified worst case 500 ps systematic trigger error includes this error, but you can avoid it by having adequate overdrive.

Rounding: Very fast pulses may suffer from pulse rounding, overshoot, or other aberrations. Pulse rounding can cause significant trigger errors, particularly when measuring on fast circuitry.

Auto Trigger

Auto Trigger is a great help especially when you measure on unknown signals. However, overshoot and ringing may cause **Auto** to choose slightly wrong MIN and MAX signal levels. This does not affect measurements like frequency, but transition time measurements may be affected.

Therefore, when working with known signals such as logic circuitry, set the trigger levels manually.

Always use manual trigger levels if the signal repetition rate is > 300 MHz or drops below 100 Hz (default), or below the low frequency limit set by entering a value between 1 Hz and 50 kHz in the menu **Auto Trig Low Freq**. You can reach it by pressing **SETTINGS** → **Misc**.

Phase

What is Phase?

Phase is the time difference between two signals of the same frequency, expressed as an angle.

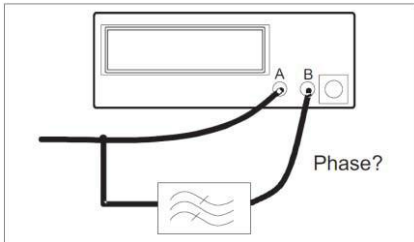

Fig. 4-19 Phase delay.

The traditional method to measure phase delay with a timer/counter is a two-step process consisting of two consecutive measurements, first a period measurement and immediately after that a time interval measurement. The phase delay is then mathematically calculated as:

$$\frac{360^\circ \times (\text{Time Interval } A-B)}{\text{Period}}$$

or in other words:

$$\text{Phase } A-B = 360^\circ \times \text{Time Delay} \times \text{FREQ}$$

A somewhat more elaborate method is used in these counters. It allows the necessary measurements to be performed in one pass by using time-stamping. Two consecutive time-stamps from trigger events on channel A and two corresponding time-stamps from

channel B are enough to calculate the result, including sign.

Resolution

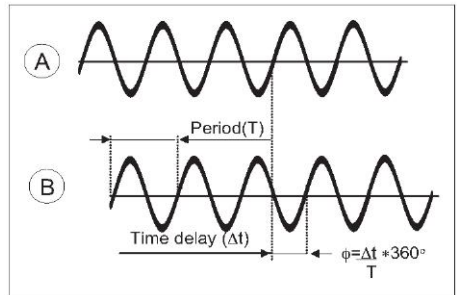

Fig. 4-20 Traditional phase definition.

The frequency range for phase is up to 160 MHz and the resolution depends on the frequency. For frequencies below 100 kHz the resolution is 0.001° and for frequencies above 10 MHz it is 1° . It can be further improved by averaging through the built-in statistics functions.

Possible Errors

Phase can be measured on input signal frequencies up to 160 MHz. However, at these very high frequencies the phase resolution is reduced to:

$$100ps \times 360^\circ \times \text{FREQ}$$

Inaccuracies

The inaccuracy of Phase A-B measurements depends on several external parameters:

- Input signal frequency
- Peak amplitude and slew rate for input signals A and B
- Input signal S/N-ratio

Some internal parameters are also important:

- Internal time delay between channel A and B signal paths
- Variations in the hysteresis window between channel A and B

Let us look deeper into the restrictions and possibilities of using phase measurements.

Inaccuracy: The measurement errors are of two kinds:

- Random errors
- Systematic errors

The *random errors* consist of resolution (quantization) and noise trigger error.

Systematic errors consist of "inter-channel delay difference" and "trigger level timing" errors. Systematic errors are constant for a given set of input signals, and in general, you can compensate for them in the controller (GPIB-systems) or locally via the **MATH/LIM** menu (manual operation) after making calibration measurements. See *Methods of Compensation* on page 4-23.

■ Random Errors

The phase quantization error algorithm is:

$$100 \text{ ps} \times \text{FREQ} \times 360^\circ$$

For example, the quantization error for a 1 MHz input signal is thus:

$$100 \text{ ps} \times 1 \times 10^6 \times 360^\circ \approx 0.04^\circ$$

The trigger noise error consists of *start* and *stop* trigger errors that should be added. For sinusoidal input signals each error is:

$$\frac{360^\circ}{2\pi \times \frac{s}{N} \text{ ratio}}$$

Let's use the example above and add some noise so that the S/N ratio will be 40 dB. This corresponds to an amplitude ratio of 100 times (and power ratio of 10000 times). Then the trigger noise will contribute to the random error with:

$$\frac{360^\circ}{2\pi \times 100} \approx 0.6^\circ$$

The sum of random errors should not be added linearly, but in an "RMS way", because of their random nature. Let's do so for our examples above.

Random error =

$$\sqrt{\text{quant. err.}^2 + \text{start trg. err.}^2 + \text{stop trg. err.}^2}$$

The total random errors are thus:

$$\sqrt{0.04^2 + 0.6^2 + 0.6^2} \approx 0.85^\circ \text{ (single-shot)}$$

What about random errors caused by internal amplifier noise? Internal noise contribution is normally negligible. The phase error caused by noise on the signal, whether internal or external, is:

$$\frac{360^\circ}{2\pi \times \frac{s}{N} \text{ ratio}}$$

For an input signal of 250 mV_{rms} and the typical internal noise figure of 250 μV_{rms} gives us a S/N-ratio of a minimum of 60 dB (1000 times). This gives us a worst case error of 0.06°. Increasing the input signal to 1.5 V_{rms} decreases the error to 0.01°.

Another way to decrease random errors is to use the statistics features of the instrument

and calculate the mean value from a number of samples.

■ **Systematic Errors in Phase Measurements**

Systematic errors consist of 3 elements:

- Inter-channel propagation delay difference.
- Trigger level timing errors (start and stop), due to trigger level uncertainty.

The inter-channel propagation delay difference is typically 500 ps at identical trigger conditions in both input channels. Therefore, the corresponding Phase difference is:

$$<0.5 \text{ ns} \times 360^\circ \times \text{FREQ}$$

See the following table.

| | |
|------------------|--------|
| 160 MHz | 28.8° |
| 100 MHz | 18.0° |
| 10MHz | 1.8° |
| 1MHz | 0.18° |
| 100 kHz | 0.018° |
| 10 kHz and below | 0.002° |

Table 4-2 Phase difference caused by inter-channel propagation delay difference

Trigger level timing error

The "trigger level timing error" is depending on two factors:

- The actual trigger point is not exactly zero, due to trigger level DAC uncertainty and comparator offset error.
- The two signals have different slew rates at the zero-crossing.

Every counter has input hysteresis. This is necessary to prevent noise to cause erroneous input triggering. The width of the hysteresis band determines the maximum sensitivity of the counter. It is approximately 30 mV, so when you set a trigger level of 0 V, the actual trigger point would normally be +15 mV and

the recovery point -15 mV. This kind of timing error is cancelled out by using hysteresis compensation.

Hysteresis compensation means that the microcomputer can offset the trigger level so that actual triggering (after offset) equals the set trigger level (before offset). This general hysteresis compensation is active in phase as well as in time interval and rise/fall time measurements. There is a certain residual uncertainty of a few mV and there is also a certain temperature drift of the trigger point.

The nominal trigger point is 0 V with an uncertainty of ± 10 mV.

A sine wave expressed as $V(t) = V_p \times \sin(2\pi ft)$, has a slew rate $\frac{\Delta V}{\Delta t}$ of $V_p \times 2\pi f$ close to

the zero-crossing. That gives us the systematic time error when crossing 10 mV, instead of crossing 0 mV.

$$\frac{10mV}{(V_p \times 2\pi \times FREQ)} (s)$$

And the corresponding phase error in degrees is:

$$\frac{10mV \times 360^\circ \times FREQ}{V_p \times 2\pi \times FREQ}$$

which can be reduced to: $\frac{0.6}{V_p} (^\circ)$

This error can occur on both inputs, so the worst case systematic error is thus:

$$\frac{0.6}{V_p(A)} + \frac{0.6}{V_p(B)} (^\circ)$$

| Vpeak (A) | Vpeak (B) | Worst case systematic error |
|-----------|-----------|---------------------------------------|
| 150 mV | 150 mV | $4^{\circ}+4^{\circ} = 8^{\circ}$ |
| 1.5 V | 150 mV | $0.4^{\circ}+4^{\circ} = 4.4^{\circ}$ |
| 1.5 V | 1.5V | $0.4^{\circ}+0.4^{\circ}=0.8^{\circ}$ |

Table 4-3 Systematic trigger level timing error (examples).

Methods of Compensation

The calculations above show the typical uncertainties in the constituents that make up the total systematic error. For a given set of input signals you can compensate for this error more or less completely by making calibration measurements. Depending on the acceptable residual error, you can use one of the methods described below. The first one is very simple but does not take the inter-channel propagation delay difference into account. The second one includes all systematic errors, if it is carried out meticulously, but it is often not practicable.

Common settings for the two inputs are:

- Slope:** Pos or Neg
- Coupling:** AC
- Impedance:** 1 MΩ or 50 Ω depending on source and frequency
- Trigger:** Man
- Trigger Level:** 0 V
- Filter:** Off

Method 1:

Connect the test signals to Input A and Input B. Select the function **Phase A rel A** to find the initial error. Use the **MATH/LIM** menu to enter this value as the constant **L** in the formula **K*X+L** by pressing **X0** and change sign. Now the current measurement result (**X0**) will be subtracted from the future phase measurements made by selecting **Phase A rel B.A** considerable part of the systematic phase errors will thus be cancelled out. Note that this

calibration has to be repeated if the frequency or the amplitude changes.

Method 2:

Connect one of the signals to be measured to both Input A and Input B via a 50 Ω power splitter or a BNC T-piece, depending on the source impedance. Make sure the cable lengths between power splitter / T-piece and instrument inputs are equal. Select the function **Phase A rel B** and read the result. Enter this value as a correction factor in the same way as described above for Method 1.

In order to minimize the errors you should also maintain the signal amplitudes at the inputs, so that the deviation between calibration and measurement is kept as small as possible.

The same restrictions as for Method 1 regarding frequency and amplitude apply to this method, i.e. you should recalibrate whenever one of these signal parameters changes.

Residual Systematic Error:

By mathematically (on the bench or in the controller) applying corrections according to one of the methods mentioned above, the systematic error will be reduced, but not fully eliminated. The residual time delay error will most probably be negligible, but a trigger level error will always remain to a certain extent, especially if the temperature conditions are not constant.

Totalize [CNT-91(R) only]

Totalize in General

The **Totalize** functions add up the number of trigger events on the two counter inputs A and B. Several combinations of them are theoretically possible. Five have been realized and made available by entering the **Totalize** menu.

In addition to controlling the gate manually by toggling **HOLD/RUN** you can also open and close the gate by using the arming facilities under **SETTINGS**. The different functions are described below.

The display is updated continually while the gate is open. Events are accumulated during consecutive open periods until **RESTART** is pressed.



The manual Totalize functions can not be used in conjunction with the Statistics functions and parameters like block and pacing. Nor does Auto Trigger work the normal way. An Auto Once is performed instead before the start of a measurement in order to calculate suitable trigger levels once.

TOT A MAN

This mode enables you to totalize (count) the number of trigger events on Channel A. Auxiliary calculated parameters are **A-B** and **A/B**. Start/Stop is manually controlled by toggling the key **HOLD/RUN**, and the counting registers are reset by pressing **RESTART**.

TOT B MAN

This mode enables you to totalize (count) the number of trigger events on Channel B. Auxiliary calculated parameters are **A-B** and **A/B**. Start/Stop is manually controlled by toggling the key **HOLD/RUN**, and the counting registers are reset by pressing **RESTART**.

TOT A+B MAN

This mode enables you to calculate the sum of trigger events on Channel A and Channel B. Auxiliary parameters are **A** and **B**. Start/Stop is manually controlled by toggling the key **HOLD/RUN**, and the counting registers are reset by pressing **RESTART**.

TOT A-B MAN

This mode enables you to calculate the difference between trigger events on Channel A and Channel B. Auxiliary parameters are **A** and **B**. Start/Stop is manually controlled by toggling the key **HOLD/RUN**, and the counting registers are reset by pressing **RESTART**.

Applications

The **TOT A-B MAN** makes it possible, for instance, to make differential flow measurements in control systems.

Example: the number of cars in a parking lot equals the number of cars passing the entrance (A) gate, minus the ones passing the exit (B) gate.

TOT A/B MAN

This mode enables you to calculate the ratio of trigger events on Channel A and Channel B. Auxiliary parameters are **A** and **B**. Start/Stop is manually controlled by toggling the key **HOLD/RUN**, and the counting registers are reset by pressing **RESTART**

Totalize & Arming

By using **Arming** together with **Totalize** you can open and close the gate with an external signal applied to one of the channels **A**, **B** or **E**. In this way you can realize a host of functions like **TOT A START/STOP by B**, **TOT A-B Gated by E** and **TOT B Timed by A**, simply by selecting channel, slope and delay time for Start/Stop.

Unlike the manual **Totalize** functions, the armed variants resemble the other measurement functions inasmuch as they allow block and pacing control. Consequently all the *Statistics* functions are available. A new result is displayed after each stop condition.

Examples

The comprehensive Arming features can be found under **SETTINGS** → **Arm**.

In order to set up the **Totalize** functions above, do the following:

■ TOT A START/STOP by B

- Select **Totalize** from the **MEAS FUNC** menu and then **A**.
- Connect the signal to be measured to Input A.
- Set the trigger level for Input A manually to a suitable value.
- Connect the control signal to Input B.
- Set the trigger level for Input B manually to a suitable value.
- Go to the Arming menu (**SETTINGS** → **Arm**) and set the seven parameters:
 - *Arm on Sample/Block*
Decide if each event or each block of events (STATISTICS mode) should be armed.
 - *Start Channel*
Select B.
 - *Start Slope*
Select POS (marked by a rising edge symbol).
 - *Start Delay*
Decide if you need to insert a delay (10 ns - 2 s) between the control signal and the actual opening of the gate.

- *Stop Delay*
Decide if you need to insert a delay (10 ns - 2 s) during which the gate will not respond to the control signal on the Stop Channel. The main application is to prevent relay contact bounces from closing the gate prematurely.

- *Stop Channel*
Select **B**.

- *Stop Slope*
Select POS (marked by a rising edge symbol).

■ **TOT A-B Gated by E**

- Select **Totalize** from the **MEAS FUNC** menu and then **A-B**.
- Connect the signals to be measured to Inputs A and B.
- Set the trigger levels for Inputs A and B manually to suitable values.
- Connect the control signal (TTL levels) to Input E.
- Go to the Arming menu (**SETTINGS** → **Arm**) and set the seven parameters:
 - *Arm on Sample/Block*
Decide if each event or each block of events (STATISTICS mode) should be armed.
 - *Start Channel*
Select **E**.
 - *Start Slope*
Select POS (marked by a rising edge symbol).
 - *Start Delay*
Decide if you need to insert a delay (10 ns - 2 s) between the control signal and the actual opening of the gate.
 - *Stop Delay*
Decide if you need to insert a delay (10 ns - 2 s) during which the gate will not respond to the control signal on the Stop Channel. The main application is to prevent relay contact bounces from closing the gate prematurely.

- *Stop Channel*
Select **E**.

- *Stop Slope*
Select NEG (marked by a falling edge symbol).

■ **TOT B Timed by A**

- Select **Totalize** from the **MEAS FUNC** menu and then **B**.
- Connect the signal to be measured to Input B.
- Set the trigger level for Input B manually to a suitable value.
- Connect the control signal to Input A.
- Set the trigger level for Input A manually to a suitable value.
- Go to the Arming menu (**SETTINGS** → **Arm**) and set the six parameters:
 - *Arm on Sample/Block*
Decide if each event or each block of events (STATISTICS mode) should be armed.
 - *Start Channel*
Select **A**.
 - *Start Slope*
Select POS (marked by a rising edge symbol).
 - *Start Delay*
Decide if you need to insert a delay (10 ns - 2 s) between the control signal and the actual opening of the gate.
 - *Stop Delay*
Set the measurement time between 10 ns and 2 s.
 - *Stop Channel*
Select **Time**.

With this function you can synchronize the start of an accurate gate time to an external event.

Voltage

V_{MAX}, V_{min}, V_{PP}

Press **MEAS FUNC** → **Volt**. The counter can measure the input voltage levels V_{MAX}, V_{MIN} and V_{PP} on DC-input voltages and on repetitive signals between 1 Hz and 400 MHz.

The default low frequency limit is 20 Hz but can be changed via the **SETTINGS** →

Miscellaneous menu between 1 Hz and 50 kHz. A higher low-frequency limit means faster measurements.

The voltage capacity is -50 V to +50 V in two automatically selected ranges.

For LF signals the measurement has "voltmeter performance", i.e. an accuracy of about 1 % of the reading.

You can select any one of the parameters to be the main parameter that is displayed in large digits and with full resolution, while the others are displayed simultaneously at the bottom of the display in smaller characters.

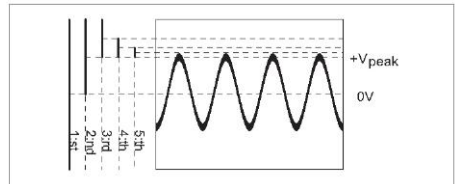

Fig. 4-21

The voltage is determined by making a series of trigger level settings and sensing when the counter triggers.

V_{RMS}

When the waveform (e.g. sinusoidal, triangular, square) of the input signal is known, its crest factor, defined as the quotient (Q_{CF}) of the peak (V_p) and RMS (V_{rms}) values, can be used to set the constant K in the mathematical function $K*X+L$. The display will then show the actual V_{rms} value of the input signal, assuming that V_{pp} is the main parameter.

$$V_{rms} = \frac{1}{2Q_{CF}} V_{pp}$$

EXAMPLE: A sine wave has a crest factor of 1.414 ($\sqrt{2}$), so the constant in the formula above will be 0.354.

Press **MATH/LIM** and after that **Math**→**Math(Off)**→**K*X+L** Press **K=** and enter **0.354** via the **NUMERIC ENTRY** keys. Check that the L constant is set to its default setting 0. Confirm your choices with the softkeys below the display. If the input is AC coupled and **V_{pp}** selected, the display will now show the RMS value of any sine wave input.

If the sine wave is superimposed on a DC voltage, the RMS value is found as: $0.354*V_{pp} + V_{DC}$. If V_{DC} is not known it can be found as:

$$V_{DC} = \frac{V_{MAX} - V_{MIN}}{2}$$

To display the rms value of a sine wave superimposed on a DC voltage, follow the example above, but set $L = V_{DC}$.

Pulsed Signals

[CNT-90 XL option 28 only]

INTRODUCTION

The option 28, named Pulsed RF option, allows the CNT-90XL counter to measure pulsed RF signal characteristics. A pulsed signal can be defined by some parameters, as described below.

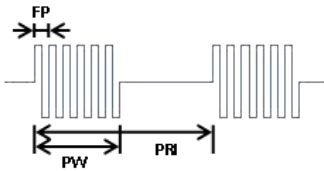

Frequency in pulse (FP): also known as carrier frequency or frequency in burst is the signal frequency within the pulse.

Pulse Width (PW): it is the pulse duration.

Pulse Repetition Interval (PRI): it is the pulse period of repetition.

Pulse Repetition Frequency (PRF): it is the reciprocal of the PRI.

Pulse Power level (P_{on}): is the signal level and is showed in dBm.

SETTINGS

To be able to measure pulsed signal main characteristics, the CNT-90XL option 28 has a special set of measurement settings.

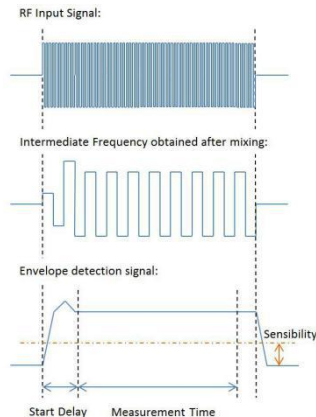

Start Delay: internal signals may need some time to be properly established. Start delay is useful to skip initial signal transient response to make sure that measurement starts when signal is stable.

Measurement time is the time during which the measurement is actually done. NOTE that measurement time must be shorter than the pulse width with some margin.

Pulse Sensitivity setting ; High/Medium/Low, corresponds to the trigger level selected for the internal pulse envelope detector signal. This setting depends on the RF signal power level.

RECOMMENDED SETTINGS

In most cases, best values to use for **start delay** and **measurement time** are respectively 10% and 80% of pulse width.

NOTE: Measurement time should end min. 40 ns before end of pulse!
Example: For a 100ns pulse, the recommended start delay is 10 ns and Meas. Time is 50ns

Sensitivity settings:

| | |
|--|--------------------|
| $P_{on} < -8\text{dBm}$ | HIGH sensitivity |
| $-8\text{dBm} < P_{on} < -3\text{dBm}$ | MEDIUM sensitivity |
| $P_{on} > -3\text{dBm}$ | LOW sensitivity |

NEEDED SETTINGS

Depending on selected measurement, some parameters need to be properly defined to get a correct result. The following table summarizes needed settings for each measurement function.

| | Manual Acq & Center freq. | Start Delay | Measurement Time | Sensitivity |
|---------------------------|---------------------------|-------------|------------------|-------------|
| Frequency in Pulse | X | X | X | X |
| Pulse Width | X | | | X |
| Pulse repetition interval | X | | | X |
| Power in pulse | X | X | X | X |

Frequency in Pulse

Note: For very short pulses (nanoseconds and lower microseconds), the resolution is limited in a single shot measurement (Values mode). To improve resolution, you should switch to STAT mode and do Statistical measurements and read the Mean Frequency value. For example 100 samples average will give one additional display digit and 10000 samples will give two additional digits.

There is also a systematic error of $<200\text{ps}/\text{Meas_time}$, that will be significant for very short pulses. This systematic error cannot be eliminated by averaging. To improve frequency accuracy for very short pulses, use the simple method below to compensate for the systematic error.



1. Before the actual pulse measurement, set up a CW generator with the same nominal frequency and level as the actual pulsed signal. That can very well be the DUT itself, if it can provide both a CW output and a pulsed output.
2. Set up the counter for CW measurements, using manual acquisition. Measure the CW mean frequency at 1sec measuring time with 10 samples. Note the value as the reference value F1.
3. Measure the CW mean frequency with a measuring time equal to the pulse width minus 40 ns. E.g. if the pulsed signal has 500 ns wide pulses, this CW measurement should be measured with 460ns measuring time. Use STAT mode with 10 000 samples, still using manual acquisition. Note the value as the "short gate" value F2.
4. The difference F2-F1 is the systematic error for a 500 nsec pulse. Enter this value as the math constant L in the counter's Math settings and select "K*X-L".
5. Perform the final pulsed RF frequency measurement with a compensated systematic error (via Math) to get a reading with minimum error.

SELECTING PULSED RF MEASUREMENTS

If Option 28 is installed in CNT-90XL, the Pulsed RF measurements are found by pressing the MEAS key and selecting Pulsed RF:

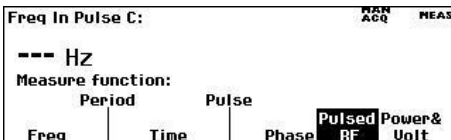

The various Pulsed RF parameters are thereafter displayed:

- Frequency in pulse
- Repetition (PRI and PRF)
- Width (Pulse Width and Duty Factor)
- Power On (the power in Pulse during On time)

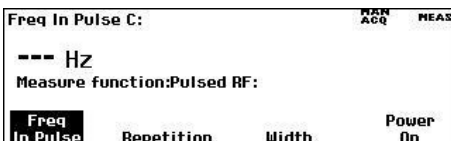

FREQUENCY IN PULSE

Select Frequency measurement via the menu

- MEAS → Pulsed RF → Freq in Pulse → C

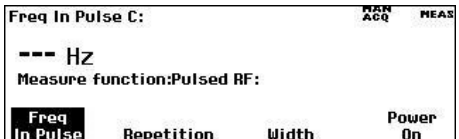

(this function is also available via the

- MEAS → Frequency in Pulse → Freq in Burst → C menu).

Set corresponding masurement settings in the following menus:

- SETTINGS → Pulsed RF

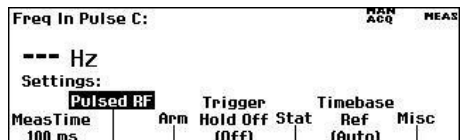

- SETTINGS → Pulsed RF → Start Delay
- SETTINGS → Pulsed RF → Meas Time
- SETTINGS → Pulsed RF → Sensitivity



And finally select Manual acquisition with a center frequency that is close to expected frequency (within 500 MHz)

- SETTINGS → Misc → Input C Acq → Center frequency

PRI

Select Pulse Repetition Interval measurement via the

- MEAS → Pulsed RF → Repetition → PRI → C.

Set corresponding measurement settings in the following menus:

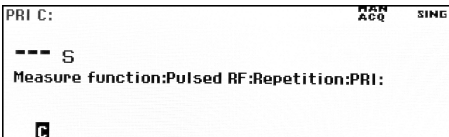
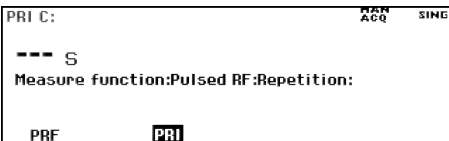

(this function is also available via the

- MEAS → Repetition → PRI → C menu).

Set corresponding measurement settings in the following menus:

- SETTINGS → Pulsed RF

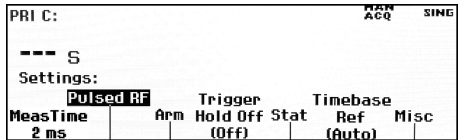

- SETTINGS → Pulsed RF → Sensitivity

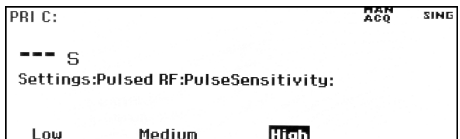
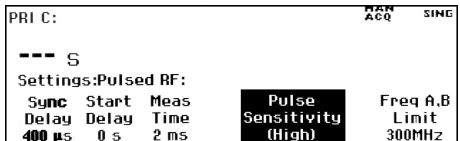

And finally select Manual acquisition with a center frequency that is close to expected frequency (within 500 MHz)

- SETTINGS → Misc → Input C Acq → Center frequency

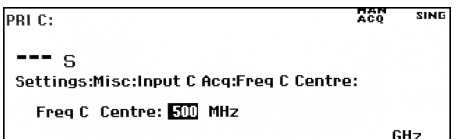
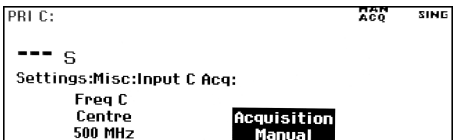
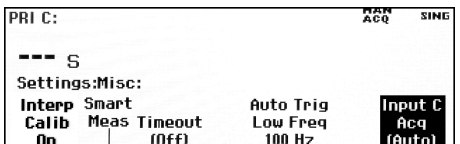

PRF

Select Pulse Repetition Frequency measurement via the

- **MEAS** → **Pulsed RF** → **Repetition** → **PRF** → **C**.

Set corresponding measurement settings in the following menus:

- **SETTINGS** → **Pulsed RF** → **Sensitivity**.
- **SETTINGS** → **Misc** → **Input C Acq** → **Center frequency**

PULSE WIDTH POS

Select Positive Pulse Width measurement via the

- **MEAS** → **Pulsed RF** → **Width** → **Pos** → **C**.

Set corresponding measurement settings in the following menus:

- **SETTINGS** → **Pulsed RF** → **Sensitivity**.
- **SETTINGS** → **Misc** → **Input C Acq** → **Center frequency**

PULSE WIDTH NEG

Select Negative Pulse Width measurement via the

- **MEAS** → **Pulsed RF** → **Width** → **Neg** → **C**.

This measure corresponds to pulse off width, or the time between pulses.

Set corresponding measurement settings in the following menus:

- **SETTINGS** → **Misc** → **Input C Acq** → **Center frequency**

DUTY FACTOR POS

Select Positive duty factor measurement via the

- **MEAS** → **Pulsed RF** → **Width** → **Duty Factor Pos** → **C**.

Set corresponding measurement settings in the following menus:

- **SETTINGS** → **Pulsed RF** → **Sensitivity**.
- **SETTINGS** → **Misc** → **Input C Acq** → **Center frequency**

Positive Duty Factor corresponds to the pulse width divided by the Pulse Repetition Interval.

DUTY FACTOR NEG

Select Negative duty factor measurement via the

- **MEAS** → **Pulsed RF** → **Width** → **Duty Factor Neg** → **C**.

Set corresponding measurement settings in the following menus:

- **SETTINGS** → **Pulsed RF** → **Sensitivity**.
- **SETTINGS** → **Misc** → **Input C Acq** → **Center frequency**

The Negative Duty Factor corresponds to the negative pulse width divided by the Pulse Repetition Interval.

POWER ON

CNT-90XL option 28 is also able to measure the power within pulses by selecting the function in the appropriate menu:

- **MEAS** → **Pulsed RF** → **Power ON** → **C**

Set corresponding measurement settings in the following menus:

- **SETTINGS** → **Pulsed RF** → **Start Delay**.
- **SETTINGS** → **Pulsed RF** → **Measurement Time**.
- **SETTINGS** → **Misc** → **Input C Acq** → **Center frequency**

Chapter 5

Measurement Control

About This Chapter

This chapter explains how you can control the start and stop of measurements and what you can obtain by doing so. The chapter starts by explaining the keys and the functions behind them, then gives some theory, and ends with actual measurement examples.

Measurement Time

This parameter is only applicable to the functions **Frequency** and **Period Average**. Increasing the measurement time gives more digits, i.e. higher resolution, but fewer measurements per second. The default value is 200 ms but can be changed via **SETTINGS** → **Meas Time** between 20 ns and 1000 s.

The default value gives 11 digits on the display and 4 to 5 measurements each second. Varying the measurement time is a hardware-based averaging method in contrast to the software-based mean value function that can be found in the **STAT/PLOT** menu.

The measurement time changes in 1/2/5 steps if you use the arrow keys for stepping. By using the numeric entry keys you can set any value within the specified range with a resolution of 10 ns.



To quickly select the lowest measurement time, enter 0. The counter will select 20 ns automatically.

Gate Indicator

The GATE LED is on when the counter is busy counting input cycles.

Single Measurements

SINGLE is implicitly the normal measurement mode, which means that the counter shows the results from a single input cycle.

The exceptions are **Frequency** and **Period Average**.

Single or **Average** is not relevant for V_{\max} , V_{\min} or V_{pp} measurements.

Hold/Run & Restart

Pressing **HOLD** completes the current measurement and freezes the result on the display.

Pressing **RESTART** initiates a new measurement.

If you are performing a statistics measurement and press **HOLD**, the pending sample will be finished. Then the measurement will stop, and you can, for instance, watch the graphic representation of the samples taken so far.

Pressing **RESTART** starts a new measurement from sample 1, and the measurement will stop when the preset number of samples has been taken.

Arming

Arming gives you the opportunity to start and stop a measurement when an external qualifier event occurs.

Start and stop of the arming function can independently be set to positive slope, negative slope, or it can be turned off. A delay between 10 ns and 2 s can be applied to the start arming channel to facilitate certain measurements. The resolution is 10 ns.

Input E on the rear panel is the normal arming input, but also input A and input B can be used. The frequency range for input E is 80 MHz, whereas it is 160 MHz for the other inputs.

All the versatile arming functions can be reached under **SETTINGS** → **Arm**.

Arming is somewhat complicated yet gives the flexibility to perform a measurement on a specific portion of a complex signal, like a frequency measurement on the color burst contained in a composite video signal.

Other examples of arming can be found later in this chapter, starting on page 5-9.

Start Arming

Start arming acts like an External Trigger on an oscilloscope. It allows the start of the actual measurement to be synchronized to an external trigger event.

In a complex signal, you may want to select a certain part to perform measurements on. For this purpose, there is an arming delay function, which delays the actual start of measurement with respect to the arming pulse, similar to a "delayed timebase" in an oscilloscope.

You can choose to delay start arming by a preset time.

Start arming can be used for all functions except **Frequency Burst**, **Ratio** and **Volt**. If you use start arming to arm an average measurement, it only controls the start of the first sample.

Stop Arming

Stop arming prevents the stop of a measurement until the counter detects a level shift on the arming input. Combining Start and Stop Arming results in an "external gate" function which determines the duration of the measurement.

Stop arming can be used for all functions except **Frequency Burst**, **Ratio**, **Volt** and **Rise/Fall Time**.

Stop Delay can only be used for realizing the function *Timed Totalize* in the CNT-91(R).

Controlling Measurement Timing

The Measurement Process

Basic Free-running Measurements

Since these counters use the reciprocal counting technique, they always synchronize the start and stop of the actual measuring period to the input signal trigger events. A new measurement automatically starts when the previous measurement is finished (unless **HOLD** is on). This is ideal for continuous wave signals.

The start of a measurement takes place when the following conditions have been met (in order):

- The counter has fully processed the previous measurement.
- All preparations for a new measurement are made.
- The input signal triggers the counter's measuring input.

The measurement ends when the input signal meets the stop trigger conditions. That happens directly after the following events:

- The set measurement time has expired (applies to **Frequency** and **Period Average** measurements only).
- The input signal fulfils the stop trigger conditions, normally when it passes the trigger window the second time.

Resolution as Function of Measurement Time

The quantization error and the number of digits on the display mainly define the resolution of the counter, that is the least-significant digit displayed.

As explained on page 4-10 under Reciprocal Counting, the calculated frequency f is:

$$f = \frac{n}{t_g}$$

while the relative rms quantization error $E_q = +100\text{ps}/t_g$.

The counter truncates irrelevant digits so that the rms quantization resolution cannot change the LSD (least-significant digit) more than ± 5 units. This occurs when the displayed value is 9999999, and the quantization error is worst

case. The best case is when the displayed value is 10000000. Then the quantization resolution corresponds to ± 0.5 LSD units.



± 1 unit in 99999999 (=1E8) means 10 times more relative resolution than ± 1 unit in 10000000 (=1E7), despite the same number of digits.

A gradual increase of the measurement time reduces the instability in the LSD caused by the quantization uncertainty. At a specific measurement time setting, the counter is justified to display one more digit. That one additional digit suddenly gives ten times more display resolution, but not a ten times less quantization uncertainty. Consequently, a measurement time that gives just one more display digit shows more visual uncertainty in the last digit.

For a stable LSD readout, the maximum measurement time selected should be one that still gives the required number of digits. Such optimization of the measurement time enables the total resolution to be equal to the quantization resolution.

Measurement Time and Rates

The set measurement time decides the length of a measurement if Frequency or Period Average is selected.

This is important to know when you want to make fast measurements, for example when you are using the statistics features, or when you are collecting data over the GPIB bus.

The so-called "dead time", that is the time between the stop of one measurement and the start of the next one in the course of a block measurement, can be below 2 μ s.

A block is a collection of consecutive measurements, the results of which are stored in local memory for statistics or plotting purposes (**STAT/PLOT** menu) or for later transfer to a controller over one of the data communication links (GPIB, USB or ETHERNET).

Additional controls over start and stop of measurements

Free-running measurements may be easy to understand, but measurements can get more complex.

Besides input signal triggering, the *start* of a measurement is further controlled by the following elements:

- Manual **RESTART**, if **HOLD** is selected.
- GPIB triggering (<GET> or *TRG), if bus triggering is selected.
- External arming signal, if **Start Arming** is selected.
- Expired start arming delay, if **Arming Delay** is selected.

In addition to expired measurement time and stop signal triggering, the *stop* of measurement is further controlled by:

- External arming signal triggering, if **Stop Arming** is selected.

GPIB triggering is described in the Programmer's Handbook.

Now let's look deeper into the concept of *arming*.

What is Arming?

Arming is a pretrigger condition ("qualifier") that must be fulfilled before the counter allows a measurement to start.

Arming can also be used to qualify the stop of a measurement. This is called "stop arming" as opposed to the more common "start arming".

When you use arming, you disable the normal free-run mode, i.e. individual measurements must be preceded by a valid start arming signal transition.

If you use start arming and stop arming together you get an externally controlled measurement time, a so-called "External Gate".

■ **Manual Arming**

The counters have a manual start arming function called **HOLD**. Here you manually arm the start of each individual measurement by pressing the **RESTART** key.

Use this manual arming mode to measure single-shot phenomena, which are either triggered manually or occur at long intervals. Another reason for using this manual arming could simply be to allow sufficient time to write down individual results.

■ **When Do I Use Start Arming?**

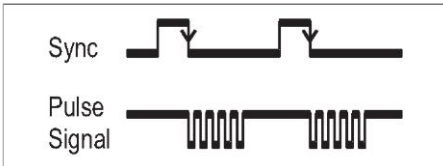

Fig. 5-1 A synchronization signal starts the measurement when start arming is used.

Start arming is useful for measurements of frequency in signals, such as the following:

- Single-shot events or non-cyclic signals.
- Pulse signals where pulse width or pulse positions can vary.
- Signals with frequency variations versus time ("profiling").

- A selected part of a complex waveform signal.

Signal sources that generate complex waveforms like pulsed RF, pulse bursts, TV line signals, or sweep signals, usually also produce a *sync* signal that coincides with the start of a sweep, length of an RF burst, or the start of a TV line. These sync signals can be used to arm the counter. See Fig. 5-1.

■ **When Do I Use Stop Arming?**

You normally use stop arming together with start arming. That means that the external gating signal controls both the start and the stop of the measurement. Such a gating signal can be used to force the counter to measure the frequency of a pulsed RF signal. Here the position of the external gate must be inside a burst. See Fig. 5-2.

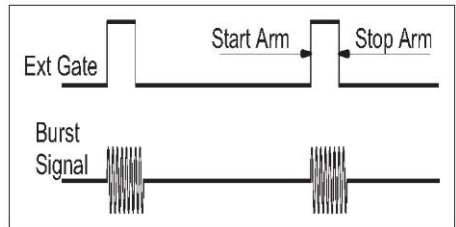

Fig. 5-2 Start and stop arming together is used for burst signal gating.

Note that burst measurements with access to an external sync signal are performed in the normal **Frequency** mode, whereas burst measurements without an external sync signal are performed in the self-synchronizing **Frequency Burst** mode.

In time interval measurements, you can use the stop arming signal as a sort of "external trigger Hold Off signal." Here you block stop triggering during the external period. See Fig. 5-3.

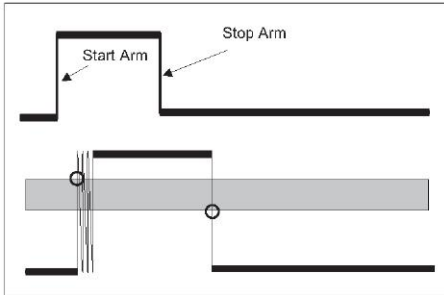

Fig. 5-3 Using arming as an external Hold Off.

■ **The Arming Input**

- **Input E** is the normal arming input. It is suitable for arming (sync) signals that have TTL levels. The trigger level is fixed at 1.4V and cannot be changed. The trigger slope can be set to positive or negative. The Input E connector can be found on the rear panel of the instrument.
- **Input A or Input B** can also be used as arming input for all single channel measurements and dual channel measurements where the arming signal is one of the measuring signals. This input is more suitable if your arming signal does not have TTL levels. All input controls such as AC/DC, Trigger Level, 50 Ω / 1 MΩ etc. can be used to condition the arming signal.

Using the measuring signal as arming signal

When performing time or frequency measurements on complex signals having a unique trigger point, input B arming can be used to make the measuring signal itself "auto-arm" the counter, e.g. to measure the frequency of a signal after it has reached a specified voltage limit (= set trigger level), see Fig. 5-4.

- Connect the signal to input A.
- Press **INPUT A** and adjust the settings to suit the interesting part of the signal.

- Press **INPUT B** and adjust the settings so that the unique trigger point can be detected. Normally **DC** coupling and **Manual** trigger level should be preferred.
- Activate start arming with or without delay on input B via the **SETTINGS** menu.

The signal on input A will be internally connected to input B, so no external signal tap is necessary.

■ **When Do I Use Arming With Delay?**

You can delay the start arming point with respect to the arming signal. Use this function when the external arming signal does not coincide with the part of the signal that you are interested in.

The time delay range is 20 ns to 2 s with a setting resolution of 10 ns.

■ **Getting The Whole Picture**

The flowchart in Fig. 5-5 illustrates how *arming a trigger hold off* enables precise control of the start and stop of the actual measurement when you operate the counter from the front panel. If you control the counter via the GPIB or USB, read more about bus arming and triggering under the heading "How to use the trigger system" in the Programmer's Handbook.

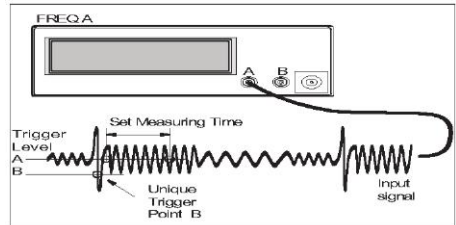

Fig. 5-4 Auto-arming using the trigger level on B as qualifier.

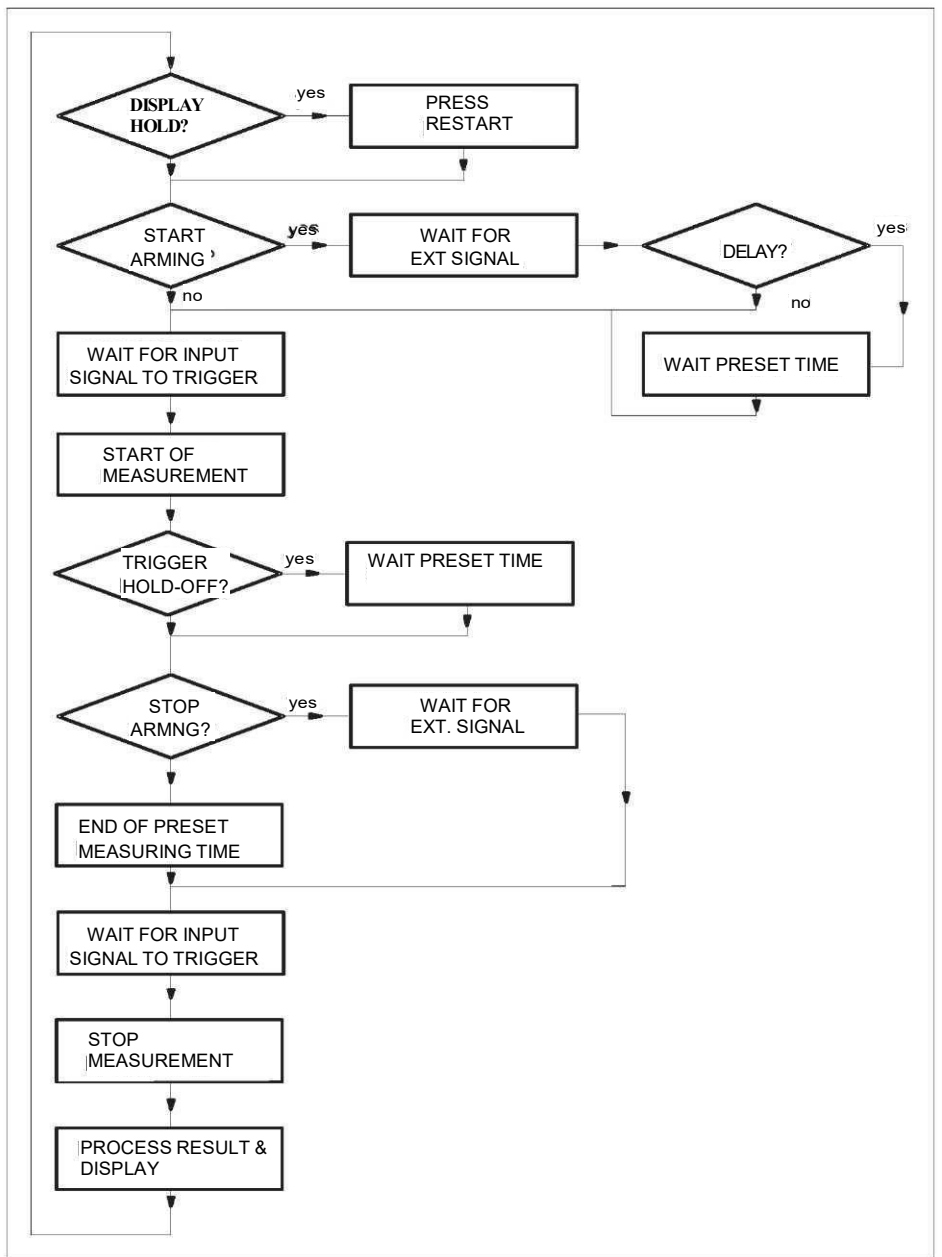

Fig. 5-5 Measurement control flow diagram.

Arming Setup Time

The arming logic needs a setup time of about 5 nanoseconds before the counter is really armed; see Fig. 5-6.

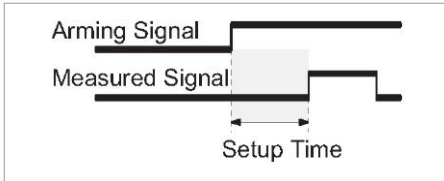

Fig. 5-6 Time from active external control edge until measurement is armed:

When arming delay is selected, the setup time is different; see Fig. 5-7. It illustrates the effect of the 100 ns delay resolution.

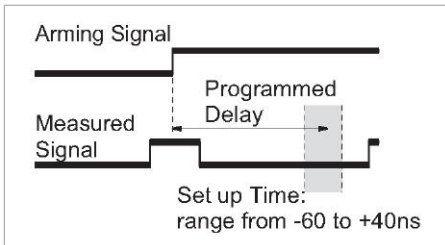

Fig. 5-7 Time from expired time delay until measurement is armed: -60 to +40 ns.

Fig. 5-7 shows that a start trigger signal may be detected although it appears 60 nanoseconds before the programmed time delay has expired. The start trigger signal must come 40 nanoseconds after the programmed time delay has expired to guarantee correct start of the measurement.

Arming Examples

Introduction to Arming Examples

The following arming examples are available:

- #1 Measuring the first pulse in a burst
- #2 Measuring the second pulse in a burst
- #3 Measuring the time between pulse #1 and #4 in a burst

#4 Profiling

Examples 1 and 2 measure the pulse width of a selected positive pulse in a burst. You can, however, also measure the period, rise time, or duty factor by changing FUNCTION, and you can measure on a negative pulse by changing trigger slope.

If you do not know the basic parameters of the signal to be measured, we recommend to use an oscilloscope for monitoring. Then you can estimate roughly how to set trigger slope, arming slope and arming delay.

#1 Measuring the First Burst Pulse

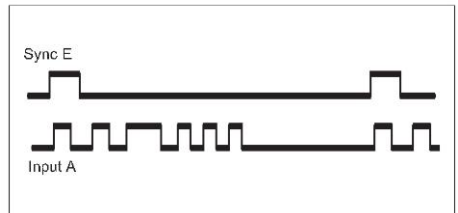

Fig. 5-8 Synchronizing the measurement so that the pulse width of the first pulse is measured.

In the first example we will measure the width of pulse #1 in a repetitive pulse burst. In this example, a synchronization signal (SYNC) with TTL levels is also available. See Fig. 5-8.

However, the quick and simple method described first does not employ arming at all but rather draws on the fact that a counter of this type tends to self-synchronize its internal processes to the input signal.

Our task is to synchronize the start of the measurement (start trigger) to the leading edge of the first pulse. Depending on the signal timing, this can be easy, difficult, or very difficult.

■ A. Auto Synchronization Without Arming

If we are lucky, we can manage without using the arming function at all. Often, the counter can automatically synchronize the measurement start to the triggering of the first pulse. The conditions for success are that the PRF is not too high, preferably below 50 Hz and certainly not above 150 Hz. The duration of a pulse burst (between first and last pulse) should be substantially less than the distance to the next burst, and the number of pulses in the burst should be more than 100 to avoid occasional miscounts.

Do the following steps to perform auto synchronization without arming:

- Connect the burst signal to input A.
- Adjust the manual sensitivity and trigger level until the burst signal triggers the counter correctly.
- Use the **MEAS/FUNC** key to select **Pulse Width A**.
- Use **Pacing Time** to select a value that approaches the time between the bursts.

Absolute synchronization will not be guaranteed in this way, but there is a high probability that auto-synchronization will work anyway. However, occasional erroneous values will be displayed. To achieve guaranteed synchronization, use the **Start Arming** function.

■ B. Synchronization Using Start Arming

The SYNC signal can be directly used to arm the measurement. This requires that the leading edge of the SYNC signal occurs more than 5 nanoseconds before the leading edge of the first pulse in the burst. See Fig. 5-9.

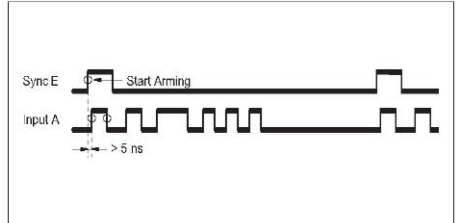

Fig. 5-9 Synchronization using start arming.

Do the following steps to perform synchronization using start arming:

- Connect SYNC to input E.
- Connect the burst signal to input A.
- Adjust the trigger level to match the burst signal under study.
- Press **SETTINGS** → **Arm**
- Select **Start Arm Delay** = 0 and **Start Chan E**.
- Use **MEAS/FUNC** to select **Pulse Width A**.

If there is no (or too little) time difference between the arming signal and the first pulse in the pulse burst, arming must be combined with a delay. See example C.

■ C. Synchronization Using Start Arming With Time Delay

If the pulse bursts have a stable repetition frequency, you synchronize the measurement using Start Arming with Time Delay. Here you use the SYNC pulse belonging to a preceding burst to synchronize the start of measurement.

Set the time delay to a time longer than the duration of a pulse burst and shorter than the repetition time of the pulse bursts.

See Fig. 5-10.

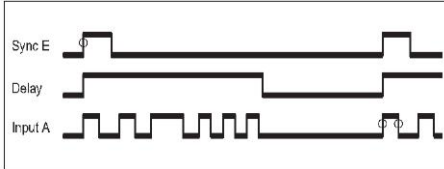

Fig. 5-10 Synchronization using start arming with time delay.

Use the same test setup as in the preceding example but enter a suitable **Start Arm Delay**.

#2 Measuring the Second Burst Pulse

The next task is to measure the width of the *second* pulse in the pulse train from example 1. How can we now synchronize the measurement start to the start of the second pulse? In this case auto-synchronization, without the use of the arming function, cannot work. Auto-synchronization can be used only to synchronize on the *first* trigger event in a burst.

Depending on the SYNC signal's position relative to the burst, and the duration of the SYNC signal, the measurement can be performed with or without using arming delay.

If the trailing edge of the SYNC signal occurs *after* the leading edge of the first pulse but *before* the second pulse in the pulse burst, then normal start arming without delay can be used. Select triggering on positive slope on input A and negative slope on input E. The slope for the active arming channel is set in the **SETTINGS** → **Arm** → **Start Slope** menu. This example is shown in the following figure:

If the SYNC-pulse timing is not so suitable as in the above measurement example, then

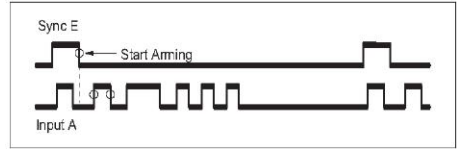

Fig. 5-11 If the trailing edge of the sync signal appears before the second pulse use arming without delay.

arming must be used combined with a time delay; see the following figure:

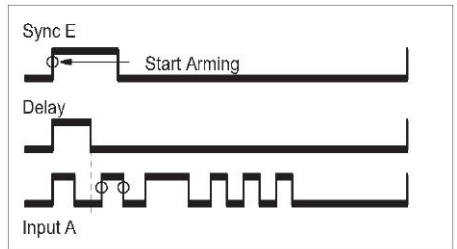

Fig. 5-12 Use arming with delay if the trailing edge of the sync signal appears too late to be useful.

Use the same test setup as in the preceding example but enter a suitable **Start Arm Delay**.

The set delay time must be set to expire in the gap between pulse #1 and #2.

#3 Measuring the Time Between Burst Pulse #1 and #4

In the previous examples, the synchronization task has been to identify the *start* of a measurement and to perform a single-shot time interval measurement. Now, we will complicate the picture even more. In our next example we will not only arm the start, but also the stop of a measurement. We will measure the time between the first and the fourth pulse in the pulse burst. We still have the SYNC signal available, see Fig. 5-13.

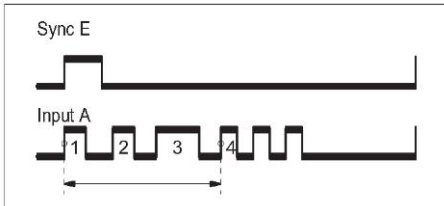

Fig. 5-13 Measuring a time interval inside a burst.

The measurement function is not Pulse Width About **Time Interval A to A** where the settings for input B are used for controlling the stop conditions. The desired start and stop trigger points are marked in the preceding illustration. Our task is now to arm both the start and the stop of this measurement. The start arming is already described in example #1, i.e., synchronize measurement start to the leading edge of the first pulse. The challenge is to synchronize the *stop* of the measurement, i.e., to arm the stop. If we do nothing, the time interval measured will be the time between the first and the second pulse. We must thus delay the stop. This can be done in different ways.

■ A. Using Trigger Hold Off to Delay the Stop a Certain Time

Trigger Hold Off is used to inhibit stop triggering during a preset time. The Hold Off

period starts synchronously with the start trigger event. The Hold Off time should be set to expire somewhere between pulse number 3 and 4, see Fig. 5-14.

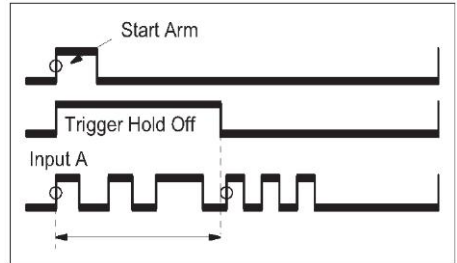

Fig. 5-14 If Hold Off expires between pulses three and four, the correct time interval is measured.

Use the same test setup as in the preceding examples. Then proceed as follows:

- Use the **MEAS/FUNC** key to select **Time Interval A to A**.
- Press **INPUT B** and choose positive slope and a suitable trigger level.
- Press **SETTINGS** → **Trigger Hold Off (On)** and enter a suitable Hold Off time.
- Make sure the start arming conditions from example #1 are maintained, i.e. no arming delay.
- Measure.

■ B. Using Stop Arming (i.e., External Hold Off) to Delay the Stop

So far in our examples, the sync signal has been used exclusively as a start arming signal; i.e., we have been concerned only about the leading edge of the sync signal, and not its duration. However, the sync signal can also be used as an *External Trigger Hold Off* when you select stop arming on the trailing edge of the sync signal. If the duration of the sync pulses can be externally varied, we can select a duration that expires in the gap between pulse #3 and #4.

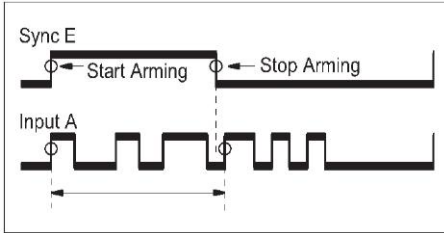

Fig. 5-15 Using both start and stop arming to select the part of the burst that is of interest.

Use the same test setup as in the preceding example. Then proceed as follows:

- Press **SETTINGS** → **Arm** and select **Stop Chan E** and negative **Stop Slope**.
- Measure.

#4 Profiling

Profiling means measuring frequency versus time. Examples are measuring warm-up drift in signal sources over hours, measuring the linearity of a frequency sweep during seconds, VCO switching characteristics during milliseconds, or the frequency changes inside a "chirp radar" pulse during microseconds. These counters can handle many profiling measurement situations with some limitations. Profiling can theoretically be done manually, i.e., by reading individual measurement results and plotting in a graph. However, to avoid getting bored long before reaching your 800th or so measurement result, you must use some computing power and a bus interface. In profiling applications, the counter acts as a fast, high-resolution sampling front end, storing results in its internal memory. These results are later transferred to the controller for analysis and graphical presentation. The TimeView™ software package greatly simplifies profiling.

You must distinguish between two different types of measurements called *free-running* and *repetitive sampling*.

■ Free-Running Measurements

Free-running measurements are performed over a longer period, e.g., to measure the stability over 24 hours of oscillators, to measure initial drift of a generator during a 30-minute warm-up time, or to measure short-term stability during 1 or 10s. In these cases, measurements are performed at user-selected intervals in the range 2 μ s to 1000 s. There are several different ways of performing the measurements at regular intervals.

Measurements using the statistics features for setting the "pacing time"

By setting the pacing time to 10 s for example, measurements are automatically made at 10 s intervals until the set number of samples has been taken. The range is 2 - 2*10⁹. Use **HOLD/RUN** and **RESTART** if you want to stop after one full cycle. You can watch the trend or spread on the graphic display while the measurement is proceeding.

Using a controller as a "pacer"

As an alternative, the timer in the controller can be used for pacing the individual measurements. This allows for synchronization with external events, for instance a change of DUT when checking a series of components.

Using external arming signals

External arming signals can also be used for "pacing." For example with an arming signal consisting of 10 Hz pulses, individual measurements are armed at 100 ms intervals.

Letting the counter run free

When the counter is free-running, the shortest delay between measurements is approximately 4 μ s (internal calibration OFF) or 8 μ s (internal calibration ON) plus set measurement time. For example, with a measurement time of 0.1 ms,

the time between each sample is approximately 104-108 μs .

■ Repetitive Sampling Profiling

The measurement setup just described will not work when the profiling demands less than 4 μs intervals between samples.

How to do a VCO step response profiling with 100 samples during a time of 10 ms.

This measurement scenario requires a *repetitive* input step signal, and you have to repeat your measurement 100 times, taking one new sample per cycle. And every new sample should be delayed 100 μs with respect to the previous one.

The easiest way to do this is by means of a controller, e.g. a PC, although it is possible but tedious to manually set and perform all 100 measurements.

The following are required to setup a measurement:

- A repetitive input signal (e.g., frequency output of VCO).
- An external SYNC signal (e.g., step voltage input to VCO).
- Use of arming delayed by a preset time (e.g., 100, 200, 300 μs).

See Fig. 5-16 and Fig. 5-17.

When all 100 measurements have been made, the results can be used to plot frequency versus time. Note that the absolute accuracy of the time scale is dependent on the input signal itself. Although the measurements are *armed* at 100 $\mu\text{s} \pm 100 \text{ ns}$ intervals, the actual *start of measurement* is always synchronized to the first input signal trigger event after arming.

The TimeView™ software package will do this measurement quickly and easily.

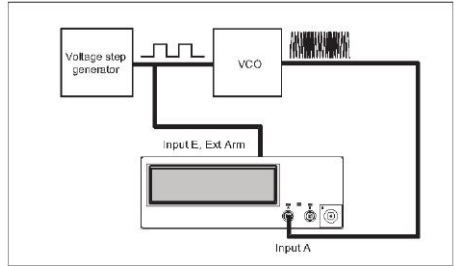

Fig. 5-16 Setup for transient profiling of a VCO.

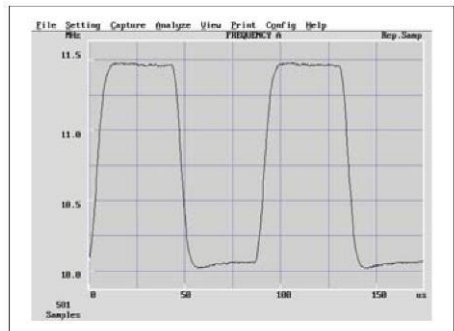

Fig. 5-17 Results from a transient profiling measurement.

Chapter 6

Process

Introduction

Three different ways to process a measuring result are available: Averaging, Mathematics and Statistics. They can be used separately or all together.

In addition to postprocessing you can also monitor the measurement results in real time by setting limits and deciding how to react when they are crossed.

Averaging

Hardware averaging by means of counting clock pulses during several full input signal cycles is only used for the measurement functions **Frequency** and **Period Average**. The parameter to be set by the operator in this case is **Meas Time** under **SETTINGS**, and the range is 20 ns to 1000 s. Longer measuring times mean higher resolution.

The other functions employ single cycle measuring, and the method to get average results is to utilize the statistics features described later.

Mathematics

The counter can use five mathematical expressions to process the measurement result before it is displayed:

1. $K \cdot X + L$
2. $K / X + L$
3. $(K \cdot X + L) / M$
4. $(K / X + L) / M$
5. $X / M - 1$

Press **MATH/LIM** → **Math** to enter the first mathematics submenu. See page 2-14 how to

enter the constants K, L and M and how to select the formula that best suits your need.

The default values of K, L and M are chosen so that the measurement result is not affected directly after activating **Math**. Recalling the default setting will restore these values as well.

Example:

If you want to observe the deviation from a certain initial frequency instead of the absolute frequency itself, you can do like this:

- Recall the default settings by pressing **USER OPT** → **Save/Recall** → **Recall Setup** → **Default**.
- Connect the signal to be measured to input A.
- Press **AUTO SET** to let the counter find the optimum trigger conditions on its own.
- Press **MATH/LIM** → **Math** → **L**
- If the current display value is suitable for your purpose, then press **X₀**. It will then be transferred to the constant L. You can repeat pressing **X₀** until you are satisfied. The constant will be updated with the latest measurement result.
- Instead of using **X₀** you can enter any numerical value from the front panel. Let's assume that 10 MHz is your reference frequency. The mantissa is marked by text inversion for immediate editing. Press **1** → **0** → **±** → **EE** → **6**.
- Confirm by pressing **EXIT/OK**. Now the constant L is updated and displayed as **-10E6**.
- Press **Math** and choose the expression **K·X+L** by pressing the softkey below it.
- Now the display will show the deviation from the value you have just entered.

By changing the constant K you can scale the result instead.

Use the expression **X/M-1** if you want the result to be displayed as a relative deviation.

$$\sigma = \sqrt{\frac{\sum_{i=1}^{N-1} (x_{i+1} - x_i)^2}{2(N-1)}}$$

It is defined as the square root of the Allan variance.

The number N in the expressions above can assume any value between 2 and $2 \cdot 10^9$.

Statistics

Statistics can be applied to all measuring functions and can also be applied to the result from **Mathematics**.

The available statistics functions are as follows:

X MAX: Displays the maximum value within a sampled population of N x_i -values.

X MIN: Displays the minimum value within a sampled population of N x_i -values.

XP-P: Displays the peak-to-peak deviation within a sampled population of N x_i values.

MEAN: Displays the arithmetic mean value (\bar{x}) of a sampled population of N x_i values and is calculated as:

$$\bar{x} = \frac{1}{N} \sum_{i=1}^N x_i$$

ST DEV: Displays the standard deviation (s) of a sampled population of N x_i -values and is calculated as:

$$s = \sqrt{\frac{\sum_{i=1}^N (x_i - \bar{x})^2}{N-1}}$$

It is defined as the square root of the variance.

A DEV: Displays the Allan deviation (σ) of a sampled population of N x_i -values and is calculated as:

Allan Deviation vs. Standard Deviation

The *Allan Deviation* is a statistic used for characterizing short-term instability (e.g. caused by jitter and flutter) by means of samples (measurements) taken at short intervals. The fundamental idea is to eliminate the influence of long-term drift due to aging, temperature or wander. This is done by making consecutive comparisons of adjacent samples.

The *Standard Deviation*, which is probably a more familiar statistic, considers the effects of all types of deviation, as all samples in the population are compared with the total mean value.

As you can see, both the *Allan Deviation* and the *Standard Deviation* are expressed in the same units as the main parameter, e.g. Hz or s.

Selecting Sampling Parameters

- Press **SETTINGS** → **Stat.**
- Press **No. of samples** and enter a new value by means of the numerical keys or the **UP/DOWN** arrow keys, if you want to change the default value of 100.
- Proceed in the same way for **No. of bins** if you want to present the measurement results graphically in a histogram.



Note that the six statistic measures are calculated and displayed simultaneously only in the non-graphic presentation mode under **STAT/PLOT**.

Use the same key for toggling between the three modes **Numerical - Histogram - Trend**.

- Press **Pacing time** and enter a new value if you want to change the default value 20 ms. The range is 2 μ s - 500 s. The pacing parameter sets the sampling interval.
- Activate the set pacing time by pressing **Pacing Off**. The status is changed to **Pacing On**. Status *Pacing Off* means that the set number of samples will be taken with minimum delay.
- Press **HOLD/RUN** to stop the measuring process.
- Press **RESTART** to initiate one data capture
- Toggle **STAT/PLOT** to view the measurement result as it is displayed in the different presentation modes.



Note that you can watch the intermediate results update the display continually until the complete data capture is ready.

This is particularly valuable if the collection of data is lengthy.

Measuring Speed

When using statistics, you must take care that the measurements do not take too long time to perform. Statistics based on 1000 samples does not give a complete measurement result until all 1000 measurements have been made, although it is true that intermediate results are displayed in the course of the data capture. Thus it can take quite some time if the setting of the counter is not optimal.

- Here are a few tips to speed up the process:
- Do not use a longer measuring time than necessary for the required resolution.
- Remember to use a short pacing time, if your application does not require data collection over a long period of time.

NOTE: If AUTO trigger is ON, the counter makes an "AUTO Once" and uses the found trigger level as fixed settings until all samples are captured. Thus the use of auto trigger does not reduce capture speed.

Determining Long or Short Time Instability

When making statistical measurements, you must select measuring time in accordance with what you want to obtain: Jitter or very short time (cycle to cycle) variations require that the samples be taken as Single measurements.

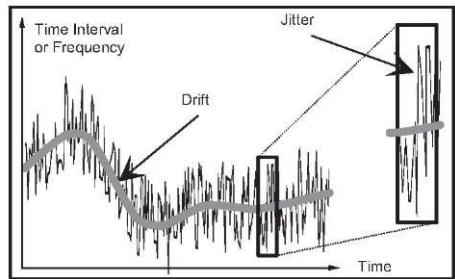

Fig. 6-1 Jitter and drift.

If average is used (Freq or Period Average only), the samples used for the statistical calculations are already averaged, unless the set measuring time is less than the period time of the input signal (up to 160 MHz). Above this frequency prescaling by two is introduced anyhow, and as a consequence a certain amount of averaging. This can be a great ad-

vantage when you measure medium or long time instabilities. Here averaging works as a smoothing function, eliminating the effect of jitter.

The signal in Fig. 6-1 contains a slower variation as well as jitter. When measuring jitter you should use a limited number of samples, so that the slow variation does not become noticeable or alternatively use the dedicated statistic measure for this kind of measurement, the Allan deviation.

To measure the slower variation you calculate Max, Min or Mean on a long series of averaged samples. Here averaging eliminates the jitter in each sample and the long measuring time and large number of samples means that the measurement can record very slow variations. The maximum pacing time is 500 s, the maximum measuring time for each sample is 1000 s, and the maximum number of samples is $2 \cdot 10^9$, which in effect means that a single data capture could theoretically span up to $3 \cdot 10^{12}$ s, or more than 95000 years.

Statistics and Mathematics

The counter allows you to perform mathematical operations on the measured value before it is presented to the display or to the bus. See Page 6-2 to get an overview of the four available equations.

Any systematic measurement uncertainty can be measured for a particular measurement setup, and the needed correction constants can be entered into these equations. Statistics will then be applied to the corrected measured value.

Confidence Limits

The standard deviation can be used to calculate the confidence limits of a measurement.

Confidence limits = $\pm ks_x$

Where:

s_x = standard deviation

$k = 1$ for a confidence level of 68.3% (1σ - limits)

$k = 2$ for a confidence level of 95.5% (2σ - limits)

$k = 3$ for a confidence level of 99.7% (3σ - limits)

■ Example

A measurement of a time interval of 100 μs is used to illustrate how the confidence limits are calculated from the measurement result.

Use the statistics to determine the mean value and standard deviation of the time interval. Take sufficient samples to get a stable reading. Assume further that the start and stop trigger transitions are fast and do not contribute to the measurement uncertainties. The counter displays:

MEAN value = 100.020 μs and a STD DEV = 50 ns, then the 95.5% confidence limits = $\pm 2s_x = \pm 2 \cdot 50 \text{ ns} = \pm 100 \text{ ns}$.

The 3σ - limit will then be $\pm 3 \cdot 50 \text{ ns} = \pm 150 \text{ ns}$

Jitter Measurements

Statistics provides an easy method of determining the short term timing instability, (jitter) of pulse parameters. The jitter is usually specified with its rms value, which is equal to the standard deviation based on single measurements. The counter can then directly measure and display the rms jitter.

Otherwise, the standard deviation of mean values can be measured. The rms value is a good measure to quantify the jitter, but it gives no information about the distribution of the measurement values.

To improve a design, it might be necessary to analyze the distribution. Such measurements as well as trend analysis can be performed by means of the built in graphic capability - toggle the **STAT/PLOT** key to see the two graphic presentation modes.

Even higher versatility can be exploited with a controller and the optional **TimeView™** Frequency and Time Analyzing Software Package.

Limits

The Limits Mode makes the counter an efficient alarm condition monitor with high flexibility as to the report possibilities.

Press **MATH/LIM** → **Limits** to enter the first Limits Menu. See below.

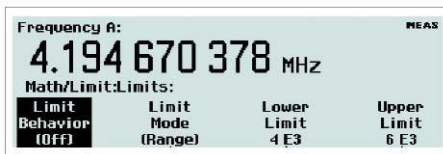

Fig. 6-2 The Limit Menu, level 1

You can set two levels by entering the submenus named Lower Limit resp. Upper Limit. Any numerical value can be entered using scientific notation. The active keys are the digits 0-9, the decimal point, the change sign (\pm) and the softkey designated EE for toggling between the mantissa and the exponent.

Typos are erased by pressing the left arrow key. Confirm by pressing **ENTER**.

Limit Behavior

Press **Limit Behavior** to set how the counter will react on limit crossings. The following choices exist:

- **Off**
No action taken. **LIM** indicator is OFF. In all other behavior modes, the **LIM** indicator is ON and non-flashing, unless the limits set in the **Limit Mode** menu have been crossed.

- **Capture**
The measurements are compared with the limits set under **Lower Limit** and **Upper Limit**, and the **LIM** symbol will be flashing when the active **Limit Mode** has set the **LIM** flag.

Only samples meeting the test criterion will be part of the population in statistics presentations.

- **Alarm**
The measurements are compared with the limits set under **Lower Limit** and **Upper Limit**, and the **LIM** symbol will be flashing when the active **Limit Mode** has set the **LIM** flag.

All samples, i.e. also those outside the limits, will be part of the population in statistics presentations.

- **Alarm_stop**
The measurements are compared with the limits set under **Lower Limit** and **Upper Limit**, and the **LIM** symbol will be flashing when the active **Limit Mode** has set the **LIM** flag.

The measurement process will stop, and the value that caused the limit detector to trigger can be read on the display.

Only samples taken before the alarm condition will be part of the population in statistics presentations.

The alarm conditions can also be detected via the SRQ function on the GPIB. See the Programmer's Handbook.

Limit Mode

The **Limit Mode** offers three choices:

- Above**

Results above the set lower limit will pass. A flashing **LIM** symbol on the display reports that the measurement result has been below the lower limit at least once since the measurement started. Use **RESTART** to reset the **LIM** symbol to its non-flashing state.
- Below**

Results below the set upper limit will pass. A flashing **LIM** symbol on the display reports that the measurement result has been above the upper limit at least once since the measurement started. Use **RESTART** to reset the **LIM** symbol to its non-flashing state.
- Range**

Results inside the set limits will pass. A flashing **LIM** symbol on the display reports that the measurement result has been below the lower limit or above the upper limit at least once since the measurement started. Use **RESTART** to reset the **LIM** symbol to its non-flashing state.

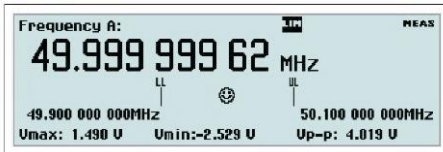

Fig. 6-3 The analog limit monitor.

If **Range** is selected and the presentation mode is **VALUES**, a one-dimensional graphic representation of the current measurement value in relation to the limits can be seen at the same time as the numerical value.

The upper limit (UL) and the lower limit (LL) are vertical bars below the main numerical display, and their numerical values are displayed in small digits adjacent to the bars. See Fig. 6-3.

This type of graphic resembles a classic analog pointer instrument, where the pointer is a "happy smiley" as long as it is positioned inside the limits and a "sad smiley" when it gets outside the limits but is still within the display

area. Values that fall outside the display area are represented by a "<" at the left edge or a ">" at the right edge.

The location of the bars is fixed, so the "inside" range takes up the mid third of the display area. This means that the resolution and the scale length are set by the limits that have been entered by the operator.

Limits and Graphics

Limits can also be applied to the two-dimensional graphics, the trend plot and the histogram. By introducing limits you can inhibit the auto-scaling and indirectly set the scale length and the resolution.

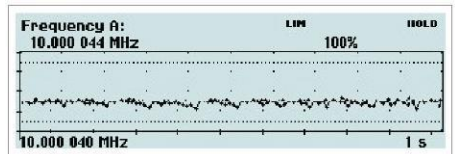

Fig. 6-4 Limits in a trend plot.

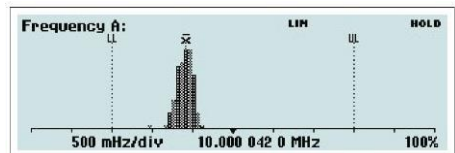

Fig. 6-5 Limits in a histogram.

This page is intentionally left blank.

Performance Check

General Information

WARNING: Before turning on the instrument, ensure that it has been installed in accordance with the Installation Instructions outlined in Chapter 1 of the User's Manual.

This performance procedure is intended for:

- checking the instrument's specification.
- incoming inspection to determine the acceptability of newly purchased instruments and recently recalibrated instruments.
- checking the necessity of recalibration after the specified recalibration intervals.

NOTE: The procedure does not check every facet of the instrument's calibration;

rather, it is concerned primarily with those parts of the instrument which are essential for determining the function of the instrument.

It is not necessary to remove the instrument cover to perform this procedure.

Preparations



Power up your instrument at least 30 minutes before checking to let it reach normal operating temperature. Failure to do so may result in certain test steps not meeting equipment specifications.

Test Equipment

| Type of Equipment | Required Specifications |
|----------------------|--|
| Reference Oscillator | 10 MHz, 1×10^{-8} (e.g. 6688) for calibrating the standard oscillator 10 MHz, 1×10^{-9} (e.g. 6689) for calibrating Opt 30/90 & Opt 40/90 |
| Voltage Calibrator | DC -50 V to +50 V (e.g. 5500) for calibrating the built-in voltage reference, alternatively corresponding DC power supply + DVM with uncertainty <0.1 % |
| LF Synthesizer | Square/ Sine up to 10 MHz, 10 V _{RMS} |
| Pulse Generator | 2 ns rise time, 5 V peak, >10 MHz, continuous & one-shot trigger |
| Oscilloscope | 350 MHz, <3% voltage uncertainty |
| RF Signal Generator | 0.1 to 3, 8, 20, 27, 40, 46, 60 GHz dep. on RF input, 10 MHz ext.ref. |
| Power Splitter | 50 Ω 6dB BNC |
| T-piece | BNC |
| Termination | 50 Ω feed through BNC |
| Low-pass Filter | 50 kHz (for 1 M Ω) load |
| BNC Cables | 5 to 7 pcs of suitable lengths |

Table 7-1 Recommended equipment for calibration and performance check.

Front Panel Controls

Internal Self-Tests

The test programs forming the self-diagnosis can be activated from the front panel as follows:

- Press **USER OPT**
- Press **Test**.
- Press **Test Mode**.
- Select one of the six tests available by pressing the softkey below the label with the name of the test function. Five of the tests (RAM, ROM, Logic, Display, and Interface) are individual. They are briefly described below. The sixth, named **All**, performs all five individual tests in sequence.
 - **All** - all tests performed in sequence
 - **RAM** - test of RAM memory
 - **ROM** - test of ROM memory
 - **Logic** - test of counter ASIC and other logic circuits.
 - **Display** - test of graphic display module
 - **Interface** - test of GPIB and USB
- Press **Start Test**.
- If a fault is detected, an error message appears on the display and the program halts. Note any error messages.
- If no faults are detected, the instrument returns to the normal measurement mode.

Keyboard Test

This test verifies that the timer/counter responds when you press any key. It is not a functional test. Such tests are performed later in this chapter. The important thing here is

that something changes on the display when you press a key. Consequently you can press the keys in almost any order without paying attention to the exact response, but for those who want to be more systematic there is a table overleaf, where all keys are exercised at least once.

Press the keys as described in the first column and look at the display for the text in the second column. Some keys change more text on the display than described here. The display text mentioned here is the one mostly associated with the selected key.

See table below for the complete list of default settings.

NOTE: For the instrument to respond correctly, this test must be carried out in sequence, and you must start with the **DEFAULT** setting. See page 2-16. No signals should be applied to the input connectors

Performance Check

| Key(s) | Display | Notes | P/F |
|--------------------|--------------------------|--|-----|
| STANDBY | Off | Red standby LED On (Key common to ON) | |
| ON | Backlight On | Red standby LED Off (Key common to STANDBY) | |
| INPUT A | Input A: | Menu for setting Slope, Coupling, Impedance etc. | |
| Man | | | |
| Trig | Trig: xy mV | Menu for entering numeric values in V or mV | |
| 0.123V | Trig: 0.123 V | | |
| ◀ (5 times) | Trig: _ V | | |
| 4.567 | Trig: 4.567 V | | |
| ◀ (5 times) | Trig: _ V | | |
| 8.9 | Trig: 8.9 V | | |
| ± | Trig: -8.9 V | | |
| mV | Trig: -8.9 mV | | |
| V | Trig: -8.9 V | | |
| AUTOSET | Menu disappears | | |
| INPUT B | Input B: | Menu for setting Slope, Coupling, Impedance etc. | |
| SETTINGS | Settings: | Menu for setting Meas Time, Hold-Off, Ref. Source etc. | |
| ENTER | Meas Time: 200 ms | | |
| ▲ | Meas Time: 500 ms | | |
| ▼ | Meas Time: 200 ms | | |
| EXIT/OK | Settings: | Menu for setting Meas Time, Hold-Off, Ref. Source etc. | |
| EXIT/OK | Menu disappears | | |
| MATH/LIM | Math/Limit: | Menu for selecting post-processing formula and alarm limit | |
| USER OPT | User options: | Menu for Calibration, Memory Management, Interface etc. | |
| CANCEL | Menu disappears | | |
| HOLD/RUN | Hold | At upper right corner | |
| HOLD/RUN | Hold disappears | | |
| MEAS FUNC | Measure function: | Menu for selecting measurement function | |
| ▶ | Period | Cursor position marked by text inversion | |
| ENTER | Single A | | |
| EXIT/OK | Menu disappears | Period Single A: at upper left corner | |
| STAT/PLOT | Period Single A | Aux parameters: Max, Min, P-P, Adev, Std | |

| Key(s) | Display | Notes | P/F |
|--------------|----------------------------------|-------|-----|
| | MEAN: | | |
| VALUE | Stat parameters disappear | | |

Table 7-2 Keyboard test

Short Form Specification Test

Sensitivity and Frequency Range

- Recall the DEFAULT settings.
- Press **INPUT A**.
- Select **50 Ω** input impedance, **1x** attenuation, **MAN**ual trigger and **Trig**ger level **0V**.
- Connect a signal from a HF generator to a BNC power splitter.
- Connect the power splitter to Input A of your counter and an oscilloscope.
- Set the input impedance to **50 Ω** on the oscilloscope.
- Adjust the amplitude according to the following table. Read the level on the oscilloscope. The timer/counter should display the correct frequency.
- Connect the signal to Input B.
- Press **INPUT B**.
- Select **50 Ω** input impedance, **1x** attenuation, **MAN**ual trigger and **Trig**ger level **0V**.
- Press **MEAS FUNC** → **Freq** → **Freq A** → **B**
- Repeat the measurements above for Input B.

| Frequency (MHz) | Level | | Pass/Fail | |
|-----------------|-------------------|-----|-----------|---------|
| | mV _{rms} | dBm | Input A | Input B |
| 10 | 15 | -23 | | |
| 50 | 15 | -23 | | |
| 100 | 15 | -23 | | |
| 200 | 15 | -23 | | |
| 300 | 25 | -19 | | |

Table 7-3 Sensitivity for inputs A & B at various frequencies

Voltage

- Recall the DEFAULT settings.
 - Press **MEAS FUNC** → **Volt** → **Vpp** → **A**
 - Press **INPUT A** and select **DC** coupling. Do not apply an input signal to Input A yet.
 - Press **EXIT/OK**.
 - The display should now indicate (disregard the main parameter VPP):
 $V_{MIN} = 0 \pm 0.015 \text{ V}$ and $V_{MAX} = 0 \pm 0.015 \text{ V}$
 - Adjust the current limit of the voltage source to <200 mA.
 - Connect +2.500 VDC to Channel A, using the external low-pass filter on the input.
 - The display should now indicate: $V_{MIN} = 2.500 \pm 0.040 \text{ V}$ and $V_{MAX} = 2.500 \pm 0.040 \text{ V}$
 - Repeat the measurement with inverted polarity.
 - Press **INPUT A** and select **10x**.
 - Press **EXIT/OK**.
- CAUTION: Before the next step, make sure the input impedance is still 1 M Ω . Applying more than 12 V without proper current limiting may cause extensive damage to the main PCB, if the impedance is set to 50 Ω .**
- Change the DC level to +50.00 V.
 - The display should now indicate: $V_{MIN} = 50.00 \pm 0.65 \text{ V}$ and $V_{MAX} = 50.00 \pm 0.65 \text{ V}$
 - Repeat the measurement with inverted polarity.
 - Disconnect the DC voltage from Channel A.
 - Remove the external low-pass filter.
 - Press **INPUT A** and select **1x**.
- Press **EXIT/OK**.
 - Connect a sinusoidal signal to Input A with an amplitude of 4.000 Vpp and a frequency of 100 kHz.
 - The display should now indicate: $4.000 \pm 0.150 \text{ VPP}$.
 - Press **INPUT A** and select **10x**.
 - Press **EXIT/OK**.
 - Change the amplitude to 18.00 VPP.
 - The display should now indicate: $18.00 \pm 0.84 \text{ VPP}$.
 - Disconnect the signal from Channel A.
 - Press **MEAS FUNC** → **Volt** → **Vpp** → **B**
 - Press **INPUT B** and select **DC** coupling. Do not apply an input signal to Input B yet.
 - Press **EXIT/OK**.
 - The display should now indicate (disregard the main parameter VPP):
 $V_{MIN} = 0 \pm 0.015 \text{ V}$ and $V_{MAX} = 0 \pm 0.015 \text{ V}$
 - Proceed by repeating the measurements for Input B as described above for Input A.

Trigger Indicators vs. Trigger Levels

| Trigger Level (manually set) | Trigger Indicator | Pass | |
|---------------------------------|-------------------|---------|---------|
| | | Input A | Input B |
| +1 V | off | | |
| 0.0 V | on | | |
| 0.5 V | blinking | | |

Table 7-4 Trigger indicator check.

NOTE: This test must be performed in the sequence given.

- Recall the DEFAULT settings.
- Press **INPUT A** and select **MAN**ual trigger level, DC coupling, and **50** Ω input impedance.
- Connect the LF synthesizer to Input A. Use the following settings (into 50 Ω): Sine, 10 kHz, 0.9 Vpp, and +0.50 V DC.
- Verify that the three modes for the trigger indicator are working properly by changing the trigger level:
- Press the **Trig** key and enter +1 V via the keyboard, then verify by pressing **EXIT/OK**. Check the trigger indicator according to Table 7-4.
- Press the **Trig** key and enter 0.0 V via the keyboard by pressing the \pm key, then

verify by pressing **EXIT/OK**. Check the trigger indicator according to Table 7-4.

- Press the **Trig** key and enter 0.5 V via the keyboard, then verify by pressing **EXIT/OK**. Check the trigger indicator according to Table 7-4.
- Apply the signal to Input B instead.
- Press **MEAS FUNC** \rightarrow **Freq** \rightarrow **Freq (A)** \rightarrow **B**
- Press **INPUT B** and select **MAN**ual trigger level, DC coupling and **50** Ω input impedance.
- Repeat the trigger level settings above to verify the three trigger indicator modes for Input B.

| Settings | V_{max} | V_{min} | Pass/Fail | |
|---------------------------------|-----------|-----------|-----------|---------|
| | | | Input A | Input B |
| INPUT A, DC, 50 Ω | +950 mV | +50 mV | | |
| AC | +450 mV | -450 mV | | |
| 10X | +0.45V | -0.45V | | |
| 1 M Ω | > +0.45 V | < -0.45 V | | |

Table 7-5 Input controls check.

Input Controls

- Recall the DEFAULT settings.
- Connect the LF synthesizer to Input A. Use the same settings as in the previous test.
- Press **INPUT A** and select **DC** and **50 Ω**.
- Press **EXIT/OK**.
- Check the first V_{\max} and V_{\min} voltage levels on the display according to the first row in Table 7-5.
- Perform the rest of the settings in sequence, and read the corresponding V_{\max} and V_{\min} values. Remember that all these values are approximate and serve only as indicators of state changes.
- Connect the generator to Input B.
- Press **MEAS FUNC** → **Freq** → **Freq(A)** → **B**.
- Press **INPUT B** and select **DC** and **50 Ω**.
- Press **EXIT/OK**.
- Check the first V_{\max} and V_{\min} voltage levels on the display according to the first row in Table 7-5.
- Perform the rest of the settings in sequence, and read the corresponding V_{\max} and V_{\min} values.

X-tal oscillators are affected by a number of external conditions like ambient temperature and supply voltage. Aging is also an important factor. Therefore it is hard to give limits for the allowed frequency deviation. The user himself must decide the limits depending on his application, and recalibrate the oscillator accordingly.

To check the accuracy of the oscillator you must have a calibrated reference signal that is at least five times more stable than the oscillator that you are testing. See Table 7-6 and the list of test equipment on page 7-2. If you use a non-10 MHz reference, you can use the mathematics in the timer/counter to multiply the reading.

- Recall the DEFAULT settings.
- Connect the reference to input A
- Check the readout against the accuracy requirements of your application.

■ Acceptance Test

Table 7-6 can serve as an acceptance test and gives a worst case figure after 30 minutes warm-up time. All deviations that can occur in a year are added together.

Reference Oscillators

| Oscillator | Frequency Readout | Suitable Reference | P/F |
|---------------------|---------------------------|--------------------|-----|
| Standard (UCXO) | 10.00000000 MHz + 150 Hz | 6688 | |
| Option 30/90 (OCXO) | 10.00000000 MHz + 1Hz | 6689 | |
| Option 40/90 (OCXO) | 10.00000000 MHz + 0.25 Hz | 6689 | |

Table 7-6 Acceptance test for oscillators.

Resolution Test

- Connect the pulse generator to a power splitter.
- Connect one side of the power splitter to Input A on the counter using a coaxial cable.
- Connect the other side of the power splitter to Input B on the counter.

Settings for the pulse generator:

- Amplitude = 2 V_{pp}, (high level +2 V and low level 0 V)
- Period = approx. 1 ms
- Duration = approx. 50 ns
- Rise time = 2 ns

Restore the timer/counter's default settings and make the following changes:

- Function = **Time A-B**
- Press **STAT/PLOT** key to the right of the display.
- Settings for **INPUT A** and **INPUT B**:

50 Ω input impedance

MANual trigger level

Trig level = 0.5V

DC coupling

The standard deviation (**Std**) should be <100 ps (90 & 90XL) or <70 ps (91).

Rear Inputs/Outputs

10 MHz OUT

- Connect an oscilloscope to the 10 MHz output on the rear of the counter. Use a coaxial cable and 50 Ω termination.
- The output voltage should be sinusoidal and >1V_{p-p}, typically 1V_{rms}.

EXT REF FREQ IN

- Recall the **DEFAULT** settings.
- Connect a stable 10 MHz signal (e.g REF OUT from another counter) to input A.
- Connect a 10 MHz, 100 mV_{RMS}, (0.28 V_{P-P}) signal from the LF synthesizer to **EXT REF IN**.
- Select Ext Ref. by keying in the following sequence:
SETTINGS → **Meas Ref** → **External**
- The display should show 10 MHz.
- Change the external reference frequency to 5 and 1 MHz.
- The counting should continue, and the display should still show 10 MHz.

| Selected Function | Action | Display | P/F |
|---------------------------------|--------|------------------|-----|
| RECALL DEFAULT ²⁾ | | | |
| FREQ A | | 10 MHz (10 dec.) | |
| FREQ B | | 10 MHz (10 dec.) | |
| FREQ RATIO A/B | | 1 (4 dec.) | |
| FREQ RATIO B/A | | 1 (4 dec.) | |
| FREQ BitB A ¹⁾ | | 10 MHz (9 dec.) | |
| FREQ BitB B ¹⁾ | | 10 MHz (9 dec.) | |
| FREQ BURST A | | 10 MHz (6 dec.) | |
| FREQ BURST B | | 10 MHz (6 dec.) | |
| PER SINGLE A | | 100 ns (2 dec.) | |
| PER SINGLE B | | 100 ns (2 dec.) | |
| PER SINGLE BitB A ¹⁾ | | 100 ns (6 dec.) | |
| PER SINGLE BitB B ¹⁾ | | 100 ns (6 dec.) | |
| PER AVERAGE A | | 100 ns (9 dec.) | |
| PER AVERAGE B | | 100 ns (9 dec.) | |
| TIME INT A - B | | 0 ns (2 dec.) | |
| TIME INT A - A | | 0 ns (2 dec.) | |
| TIME INT B - A | | 0 ns (2 dec.) | |
| TIME INT B - B | | 0 ns (2 dec.) | |
| SLOPE B | | | |
| TIME INT A - B | | 50 ns (2 dec.) | |
| RISE TIME A | | 30 ns (2 dec.) | |
| RISE TIME B | | 30 ns (2 dec.) | |
| FALL TIME A | | 30 ns (2 dec.) | |
| FALL TIME B | | 30 ns (2 dec.) | |
| TIE A ¹⁾ | | 0 ns (2 dec.) | |
| TIE B ¹⁾ | | 0 ns (2 dec.) | |
| PULSE W POS A | | 50 ns (2 dec.) | |
| PULSE W NEG A | | 50 ns (2 dec.) | |
| PULSE W POS B | | 50 ns (2 dec.) | |
| PULSE W NEG B | | 50 ns (2 dec.) | |
| DUTY POS A | | 0.5 (3 dec.) | |
| DUTY NEG A | | 0.5 (3 dec.) | |
| DUTY POS B | | 0.5 (3 dec.) | |
| DUTY NEG B | | 0.5 (3 dec.) | |
| RECALL DEFAULT | | | |
| PHASE A rel A | | 0° (360°) | |
| PHASE A rel B | | 0° (360°) | |
| PHASE B rel A | | 0° (360°) | |
| PHASE B rel B | | 0° (360°) | |
| TOT A | | incrementing | |
| TOT B | | incrementing | |
| TOT A+B | | incrementing | |
| TOT A-B | | 0 | |
| TOT A/B | | 1.000... | |
| VOLT P-P A | | 1.5 (3 dec.) | |
| VOLT MAX A | | 750 mV | |
| VOLT MIN A | | -750 mV | |
| VOLT P-P B | | 1.5 (3 dec.) | |
| VOLT MAX B | | 750 mV | |
| VOLT MIN B | | -750 mV | |

Table 7-7 Measuring functions check

Notes: 1) Applies to CNT-91 only; 2) Change default set tings according to "Measuring Functions" below.

EXT ARM IN

- Proceed from the test above.
- Select **MAN**ual trigger.
- Settings for the pulse generator: single shot pulse, manual trigger, amplitude TTL = 0 - 2 V_{pp}, and duration = 10 ns.
- Connect the pulse generator to Ext Arm Input.
- Activate start arming by keying in the following sequence:
SETTINGS → **Start Chan** → **E**
- The counter does not measure.
- Apply one single pulse to Ext Arm Input.
- The counter measures once and shows 10 MHz on the display.

PULSE OUT (CNT-91 only)

- Connect an oscilloscope to the pulse output on the rear panel with a 50 Ω coaxial cable terminated at the scope input with 50 Ω (internally or externally).
- Select the pulse output by keying in the following sequence: **USER OPT** → **Output** → **Output Mode** → **Puls Gen**
- Select Pulse Period and set the value to 1000 ns.
- Select Pulse Width and set the value to 500 ns.
- The output signal should be a pure square wave signal with 1 MHz frequency and 50 % duty cycle. The rise/fall time should be approximately 2 ns. The low and the high level should be <0.2 V resp. >2.4 V.

Additional outputs (CNT-91R/71B only)

- Connect a DSO with 50 Ω inputs to the BNC connectors, one at time.
- Verify that the four output signals are sinusoidal and that the voltage is $>1V_{p-p}$, typically 1V_{rms}.
- Connect the timer/counter and verify that the frequency is 10MHz \pm 0.01Hz, 5MHz \pm 0.005Hz, 1MHz \pm 0.001Hz and 0.0MHz \pm 0.0001Hz respectively.

Measuring Functions

- Connect a 10 MHz sine wave signal with approx. 1 V_{RMS} amplitude into 50 Ω via a power splitter to Input A and Input B, e.g from 10 MHz Out on the rear panel.
- Recall the DEFAULT settings.

Select the following settings for the timer/counter via **INPUT A** and **INPUT B**:

- **DC, 50 Ω , Man, 0 V**
- Check that the timer/counter performs the correct measurement by displaying the results shown in the “Display” column of Table 7-7.
- Select function via **MEAS FUNC**.
- *Note that the results are rounded off and very approximate. No tolerances are given for this test.*
- The CNT-90 and the CNT-91 with optional RF inputs as well as the CNT-90XL with its various microwave converters all require an external RF source to verify Input C. A simple functional check can be performed by connecting a 1 GHz, -10 dBm signal after

selecting Freq C. No other settings need to be changed.

- Read 1 GHz on the display and for the CNT-90XL also the input power level (about -10 dBm).

Check of HOLD OFF Function

- Recall the DEFAULT settings.
- Select **Period Single A**.

Select the following common timer/counter settings for both Input A and Input B via the hard menu keys **INPUT A** and **INPUT B**:

- **50 Ω** impedance.
- **DC** coupling.
- **MAN**ual trigger, x1 attenuation.
- Press **SETTINGS** and activate **Hold Off**. Select **Hold Off On** and set the **Trigger Hold Off** time to the minimum value 20 ns.
- Connect the rear panel output marked 10 MHz OUT to Input A.
- Increase the **Trigger Hold Off** time in steps by means of the **UP** cursor key and note the results:

If Trigger Hold Off time <100 ns the result is about 100 ns, i.e. the same value as without Hold Off.

If Trigger Hold Off time >100 ns the result is about 100 ns + Trig Hold Off time.

- Connect the signal to Input B, select **Period Single B** and repeat the tests above.

RF Inputs

CAUTION: Three similar but incompatible coaxial connector standards are used in the CNT-90XL, depending on the frequency range. Do not mix them up, as abuse might damage the connectors and cause unexpected results. See the specifications in Chapter 8 of the User's Manual.

Sensitivity

To verify the specifications of the different RF prescalers (CNT-90 & CNT-91) or Microwave Converters (CNT-90XL-xxG) use the following basic test setup:

- Connect the output of a signal generator covering the specified frequency range to the RF input (C) of the counter.
- Connect the 10 MHz REF OUT from the generator to the EXT REF IN on the rear panel of the counter.
- Choose Meas Ref from the SETTINGS menu and select External.
- Choose Freq C from the MEAS FUNC menu.
- Generate a sine wave in accordance with the data in the relevant table (Table 2-9, Table 2-13, Table 2-12, Table 2-11 and Table 2-10).
- Verify that the counter is counting correctly. (The last digits will be unstable).

| Frequency | Amplitude | | P/F |
|-----------|-----------|-------|-----|
| | MHz | mVRMS | |
| 100-300 | 20 | -21 | |
| 300-2500 | 10 | -27 | |
| 2500-2700 | 20 | -21 | |
| 2700-3000 | 40 | -15 | |

Table 7-8 RF input sensitivity, 3 GHz Option.

| Frequency | Amplitude | | P/F |
|-----------|-----------|-------|-----|
| | MHz | mVRMS | |
| 300-500 | 20 | -21 | |
| 500-3000 | 10 | -27 | |
| 3000-4500 | 20 | -21 | |
| 4500-6000 | 40 | -15 | |
| 6000-8000 | 80 | -9 | |

Table 7-9 RF input sensitivity, 8 GHz Option.

| Frequency | Amplitude | | P/F |
|-------------|-----------|-------|-----|
| | GHz | mVRMS | |
| 0.25 to 0.5 | 20 | -21 | |
| 0.5 to 15 | 10 | -27 | |

Table 7-10 RF input sensitivity, 14 GHz Option.

| Frequency | Amplitude | | P/F |
|-------------|-----------|-------|-----|
| | GHz | mVRMS | |
| 0.25 to 0.5 | 20 | -21 | |
| 0.5 to 17 | 10 | -27 | |
| 17 to 20 | 20 | -21 | |

Table 7-11 RF input sensitivity, 20 GHz Option.

| Frequency | Amplitude | | P/F |
|-----------------------|-----------|-------|-----|
| | GHz | mVRMS | |
| 0.3 to 18 | 5 | -33 | |
| 18 to 20 | 8 | -29 | |
| 20 to 27 | 10 | -27 | |
| 27 to 40 ¹ | 16 | -23 | |
| 40 to 46 ² | 32 | -17 | |
| 46 to 60 ² | 40 | -15 | |

Table 7-12 RF input sensitivity, CNT-90XL.

Notes:

¹ not CNT-90XL-27G

² not CNT-90XL-27G | 40G

³ not CNT-90XL-27G | 40G | 46G

Manual Acquisition (CNT-90XL only)

- Recall the default settings and select Freq C.
- Connect 1 GHz, -10 dBm to Input C.
- Check that the correct result can be read on the display.
- Press **SETTINGS** → **Misc** → **Input C Acq**
- Press **Freq C Center** and change the default value 300 MHz to 1 GHz.
- Press **Acquisition** to change Auto to Manual.
- Note the sign **M.ACQ** on the display.
- Sweep the input frequency manually and observe the lower and upper limits for the capture range. They should be <925 MHz and >1075 MHz respectively.

Power (CNT-90XL only)

Use the same test setup as in the section *Sensitivity* above. Make sure the generator is well calibrated, and connect it to the DUT with as short a cable as possible to avoid losses.

- Choose **Power & Volt @ Power @ C** from the **MEAS FUNC** menu.
- Verify the data in Table 2-14.
- Check that the auxiliary parameter “frequency” is displayed correctly at the same time.

| Freq. (GHz) | Power (dBm) | | | P/F |
|-----------------|-------------|--------|------|-----|
| | Appl. | Displ. | Tol. | |
| 27 | -20 | -20 | ±1 | |
| 40 ¹ | -15 | -15 | ±2 | |
| 46 ² | -10 | -10 | ±2 | |
| 60 ² | -5 | -5 | ±3 | |

Table 7-13 Power measurement, CNT-90XL.

Notes:

¹ not CNT-90XL-27G

² not CNT-90XL-27G | 40G

³ not CNT-90XL-27G | 40G | 46G

Performance check procedure of option 28 Pulsed RF

Necessary equipment:

1. RF Generator to 27 or 40 GHz (depending on CNT-90XL model) with pulse modulation input and external 10 MHz Ref Freq. Input
OR
RF Generator to 27 or 40 GHz (depending on CNT-90XL model) with modulation input and external 10 MHz Ref Freq. Output
2. Waveform/pulse generator.
3. Power meter, with accuracy 0.1 dBm or better, and with a calibrated RF-c (known loss for all test frequencies)
4. 50 ohm power splitter

Setup:

1. Connect the output of the Pulse Generator to the Pulse or Modulation input of the RF Generator and enable external modulation mode.
2. Make sure both the RF generator and the CNT-90XL (Device Under Test) use the same Reference frequency. Either
 - a. - connect the 10 MHz output (rear panel) of the CNT-90XL to the Ext. Reference 10 MHz input of the RF generator. This is shown in the picture below
 - b. - OR connect the 10 MHz output of the RF generator to the Ext. Reference input of the CNT-90XL (rear panel)

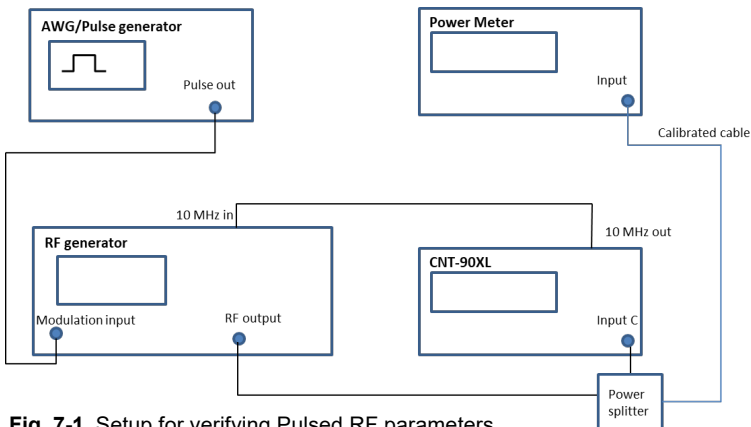

Fig. 7-1. Setup for verifying Pulsed RF parameters

1. Setup the pulse generator to generate a pulse signal with Pulse repetition interval of 1ms, Pulse width = 100µs and signal level from 0 to 1 Volt
2. Set HF generator signal to 1 GHz, - 10dBm
3. Connect a 50 ohm power splitter to the RF generator output. Connect one output of the splitter with a **short** (low loss) cable to the CNT-90XL. Connect the other output to the power meter. Note the power meter reading as the reference value.

Adjust the RF generator output until the desired output level is read on the power meter, compensated for the loss in the input cable from the power splitter.

4. Set up the CNT-90XL unit :
 - a. Set unit to Pulsed RF frequency measurement mode:
“Meas Func => Pulsed RF => Freq in Pulse => C”
 - b. Set manual acquisition mode ON, and set the center frequency to 1GHz:
“Settings => Misc => Input C Acq => Manual and “Freq C Centre“ to 1GHz
 - c. Set up the measurements parameters:
“Settings => Pulsed RF” and set: **“Start delay”** to 10us, **“Meas Time”** to 80us, **“Pulse Sensitivity => High”**.
 - d. Set up Statistics parameters:
“Settings=>Statistics” and set: **“No of samples”** to 100, Enter **“Stat/Plot”** viewing mode.

This will set up the test set to the first frequency measurement.

The following measurements should be made, by changing the required parameters.

Frequency in Pulse: Sensitivity

| RF generator | | Pulse generator | | Counter | | | | Frequency measured | Tolerance | P/F |
|--------------|---------|-----------------|---------------------------|-------------|------------------|-------------|----------------------|--------------------|-----------|-----|
| Frequency | Power | Pulse width | Pulse repetition interval | Start delay | Measurement time | Sensitivity | Manual acq frequency | | | |
| 400 MHz | -20 dBm | 100 µs | 1 ms | 10 µs | 80 µs | HIGH | 400 MHz | ±1 MHz | | |
| 1 GHz | -20 dBm | 100 µs | 1 ms | 10 µs | 80 µs | HIGH | 1 GHz | ±1 MHz | | |
| 10 GHz | -20 dBm | 100 µs | 1 ms | 10 µs | 80 µs | HIGH | 10 GHz | ±10 MHz | | |
| 27 GHz | -20 dBm | 100 µs | 1 ms | 10 µs | 80 µs | HIGH | 27 GHz | ±10 MHz | | |
| 40 GHz | -15 dBm | 100 µs | 1 ms | 10 µs | 80 µs | HIGH | 40 GHz | ±10 MHz | | |

Table 7-14. Sensitivity measurements:

Frequency in Pulse: Accuracy without short-pulse compensation

Change RF generator output level to -10 dBm

The following measurements should be made, by changing the required parameters.

| RF generator | | Pulse generator | | Counter | | | | Frequency measured | Tolerance | P/F |
|--------------|---------|-----------------|---------------------------|-------------|------------------|-------------|----------------------|--------------------|-----------|-----|
| Frequency | Power | Pulse width | Pulse repetition interval | Start delay | Measurement time | Sensitivity | Manual acq frequency | | | |
| 1 GHz | -10 dBm | 100 ns | 1 ms | 10 ns | 50 ns | HIGH | 1 GHz | ±0.5 MHz | | |
| 1 GHz | -10 dBm | 500 ns | 1 ms | 50 ns | 410 ns | HIGH | 1 GHz | ±64 kHz | | |
| 1 GHz | -10 dBm | 1 μs | 1 ms | 100 ns | 800 ns | HIGH | 1 GHz | ±32 kHz | | |
| 1 GHz | -10 dBm | 10 μs | 1 ms | 1 μs | 8 μs | HIGH | 1 GHz | ±3.2 kHz | | |
| 1 GHz | -10 dBm | 100 μs | 1 ms | 10 μs | 80 μs | HIGH | 1 GHz | ±0.5 kHz | | |

Table 7-15. Frequency accuracy measurements without short-pulse compensation

Frequency in Pulse: Accuracy with short-pulse compensation

The systematic error of $<200\text{ps}/\text{Meas_time}$, can be significant for very short pulses, below 10 μs. This systematic error cannot be eliminated by averaging, but reduced to $<50\text{ps}/\text{Meas_Time}$ by compensation of the systematic error for a specific pulse width.

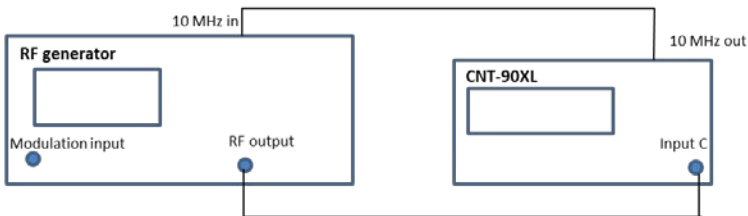

Fig. 7-2. Setup for measuring short-pulse systematic error

1. Set up the RF generator to 1 GHz and -10 dB
2. Set up the CNT-90XL counter for Freq CW measurements:
“Meas Func => Frequency => Freq => C”
 still using manual acquisition.
3. Measure the CW mean frequency at 200 msec measuring time with **N=10 samples**. Note the value as the reference value F1 in table 3 below
4. Measure the CW mean frequency with a measuring time equal to 90% of the actual pulse width minus 40 ns. E.g. if the pulsed signal has 500 ns wide pulses, this CW measurement should be measured with 410 ns measuring time.
 Use STAT mode with **N = 100 000 samples**.
 Repeat the measurement for PW= 100ns, 500 ns, 1 μ s and 10 μ s
5. Note the value as the “short gate” value F2 in table 3 below.
 The difference F2-F1 is the systematic CW error for a short pulse.
6. Enable Math and enter this value $-(F2-F1)$ as the Math constant L in the counter’s Math settings and select **“K*X+L”**.
“Math/Limit => Math => K*X+L”, set **L = $-(F2-F1)$**
7. Perform the final pulsed RF frequency measurement
“Meas Func => Pulsed RF => Freq in Pulse => C”
 with **N=100 000 samples** and a compensated systematic error (via **Math $K*X+L$**) to get a reading with minimum systematic error

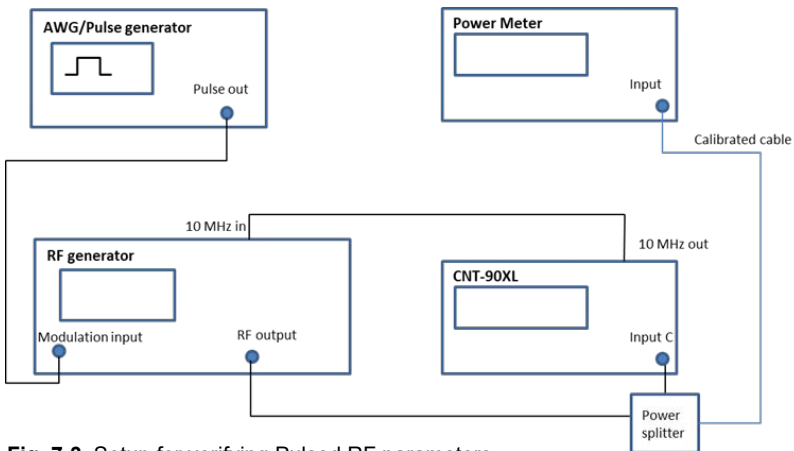

Fig. 7-3. Setup for verifying Pulsed RF parameters

| RF generator | | Pulse generator | | Counter | | | | | | | | |
|--------------|---------|-----------------|------|-------------|------------------|-------------|----------------------|----------|----------|---------------------------|-----------|-----|
| Frequency | Power | Pulse width | PRI | Start delay | Measurement time | Sensitivity | Manual acq frequency | F1 (GHz) | F2 (GHz) | Frequency measured +F1-F2 | Tolerance | P/F |
| 1 GHz | -10 dBm | 100 ns | 1 ms | 10 ns | 50 ns | HIGH | 1 GHz | | | | ±0.15 MHz | |
| 1 GHz | -10 dBm | 500 ns | 1 ms | 50 ns | 410 ns | HIGH | 1 GHz | | | | ±15 kHz | |
| 1 GHz | -10 dBm | 1 µs | 1 ms | 100 ns | 800 ns | HIGH | 1 GHz | | | | ±7.5 kHz | |
| 1 GHz | -10 dBm | 10 µs | 1 ms | 1 µs | 8 µs | HIGH | 1 GHz | | | | ±0.8 kHz | |

Table 7-16. Frequency accuracy with short-pulse compensation:

Pulse width measurements

Set up Pulsed RF Pulse Width measurement on the CNT-90XL

“Meas Func => Pulsed RF => Width => Pos => C”

The following measurements should be made, by changing the required parameters.

| RF generator | | Pulse generator | | Counter | | | | |
|--------------|---------|-----------------|---------------------------|-------------|----------------------|----------------------|-----------|-----|
| Frequency | Power | Pulse width | Pulse repetition interval | Sensitivity | Manual acq frequency | Pulse width measured | Tolerance | P/F |
| 1 GHz | -10 dBm | 50 ns | 1 ms | HIGH | 1 GHz | | ±12 ns | |
| 1 GHz | -10 dBm | 100 ns | 1 ms | HIGH | 1 GHz | | ±12 ns | |
| 1 GHz | -10 dBm | 1 µs | 1 ms | HIGH | 1 GHz | | ±12 ns | |
| 1 GHz | -10 dBm | 10 µs | 1 ms | HIGH | 1 GHz | | ±12 ns | |
| 1 GHz | -10 dBm | 100 µs | 1 ms | HIGH | 1 GHz | | ±12 ns | |

Table 7-17. Pulse width measurement

PRI measurements

Set up Pulsed RF PRI measurement on the CNT-90XL

“Meas Func=> Pulsed RF=> Repetition=> PRI =>C”

The following measurements should be made, by changing the required parameters.

| RF generator | | Pulse generator | | Counter | | Pulse width measured | Tolerance | P/F |
|--------------|---------|-----------------|---------------------------|-------------|----------------------|----------------------|-----------|-----|
| Frequency | Power | Pulse width | Pulse repetition interval | Sensitivity | Manual acq frequency | | | |
| 1 GHz | -10 dBm | 30 ns | 60 ns | HIGH | 1 GHz | | ±2.4 ns | |
| 1 GHz | -10 dBm | 500 ns | 1 µs | HIGH | 1 GHz | | ±2.4 ns | |
| 1 GHz | -10 dBm | 5 µs | 10 µs | HIGH | 1 GHz | | ±2.4 ns | |
| 1 GHz | -10 dBm | 50 µs | 100 µs | HIGH | 1 GHz | | ±2.4 ns | |
| 1 GHz | -10 dBm | 500 µs | 1 ms | HIGH | 1 GHz | | ±2.4 ns | |

Table 7-18. PRI measurement

Power measurement:

Set up Pulsed RF PRI measurement on the CNT-90XL

“Meas Func=> Pulsed RF=> Power On =>C”

The following measurements should be made, by changing the required parameters. Note: Read the power level on the Power meter, compensated for the loss in the RF cable, not on the RF generator

Power sensitivity:

| RF generator | | Pulse generator | | Counter | | | | Power measured dBm | Tolerance | P/F |
|--------------|---------|-----------------|---------------------------|-------------|------------------|-------------|----------------------|--------------------|-------------|-----|
| Frequency | Power | Pulse width | Pulse repetition interval | Start delay | Measurement time | Sensitivity | Manual acq frequency | | | |
| 1 GHz | -15 dBm | 100 μ s | 1 ms | 10 μ s | 80 μ s | HIGH | 1 GHz | | ± 2 dBm | |
| 1 GHz | -10 dBm | 100 μ s | 1 ms | 10 μ s | 80 μ s | HIGH | 1 GHz | | ± 2 dBm | |
| 1 GHz | -5 dBm | 100 μ s | 1 ms | 10 μ s | 80 μ s | MED | 1 GHz | | ± 2 dBm | |
| 1 GHz | -0 dBm | 100 μ s | 1 ms | 10 μ s | 80 μ s | LOW | 1 GHz | | ± 2 dBm | |
| 1 GHz | +10 dBm | 100 μ s | 1 ms | 10 μ s | 80 μ s | LOW | 1 GHz | | ± 2 dBm | |

Table 7-19. Power sensitivity measurement

Power accuracy:

| RF generator | | Pulse generator | | Counter | | | | Power measured | Tolerance | P/F |
|--------------|---------|-----------------|---------------------------|-------------|------------------|-------------|----------------------|----------------|---------------|-----|
| Frequency | Power | Pulse width | Pulse repetition interval | Start delay | Measurement time | Sensitivity | Manual acq frequency | | | |
| 1 GHz | -10 dBm | 50 μ s | 1 ms | 5 μ s | 44 μ s | HIGH | 1 GHz | | ± 1.2 dBm | |
| 1 GHz | -10 dBm | 100 μ s | 1 ms | 10 μ s | 80 μ s | HIGH | 1 GHz | | ± 1.2 dBm | |
| 1 GHz | -10 dBm | 1 ms | 10 ms | 100 μ s | 800 μ s | HIGH | 1 GHz | | ± 1.2 dBm | |

Table 7-20. Power accuracy measurement

Battery Supply

Option 23/90 for CNT-90 & CNT-90XL only

- Power up the instrument with the power cord disconnected.
 - The power supply status indicator next to the left of the charging level indicator in the upper right corner of the display shall now show a battery symbol. It indicates that the internal battery is the active power source.
 - Press **USER OPT** → **Misc**, and select **Use Battery in Standby Yes** to make sure the instrument will continue to operate in case line power fails.
 - If the charging level is above 60 %, let the instrument be running until the level goes below 60 %.
 - Connect the power cord to the mains.
 - The status indicator shall now change to a charging battery symbol.
 - Let the battery charge for at least 8.5 h in normal operational mode.
 - When the specified charging time has elapsed, the level indicator shall show a value close to 100 %.
 - Disconnect the power cord and wait 10 s, then reconnect the power cord.
 - The status indicator shall now show a power plug symbol on top of the battery symbol. This means that the power line takes priority but will be replaced by the battery if the mains voltage drops out.
- Note: Charging will not be resumed until the level goes below about 70 % in order to cycle the battery more efficiently.

- Recall the default settings by pressing **USER OPT** → **Save/Recall** → **Recall Setup** → **Default**.
 - Connect **10 MHz OUT** on the rear panel to **Input A**, and select **Freq A**.
 - Check that the instrument is working and shows a value close to 10 MHz.
 - Disconnect the power cord, and check that the instrument goes on working.
- Note: The power plug symbol disappears, leaving the battery symbol alone.
- Check that the instrument operates >4.5 h without connection to the mains.
 - Power down the instrument by pressing the green power switch key.
 - Check that the red standby LED lights up.
 - Power up the instrument again, and check that it powers down automatically when the battery is almost empty.
 - Connect the power cord, and power up the instrument.
 - Check that the standby LED goes out.
 - Check that the status indicator shows a charging battery symbol.
 - Let the battery charge to its full capacity.
 - Power down, wait 10s, and power up
 - Press **USER OPT** → **Misc**, and select **Use Battery in Standby No** to make sure the instrument will not continue to operate in case line power fails.
- Note: The battery symbol disappears, leaving the power plug symbol alone.
- Disconnect the power cord, and check that the instrument stops working. The standby LED shall not light up.

Chapter 8

Specifications

CNT-90

Introduction

Only values with tolerances or limits are guaranteed data. Values without tolerances are informative data, without guarantee.

Measurement Functions

Refer to page 8-55 for uncertainty information.

Inputs A and B can be swapped in all modes except **Rise Time** and **Fall Time**.

Display: All measurements are displayed with a large main parameter value and smaller auxiliary parameter values (with less resolution). Some measurements are only available as auxiliary parameters.

Frequency A, B, C

■ Range:

| | |
|----------|---|
| Input A: | 0.002 Hz - 400 MHz |
| Input B: | 0.002 Hz - 400 MHz |
| Input C: | 100 MHz - 3 GHz (Opt. 10) 300 MHz - 8 GHz (Opt. 13) 200 MHz - 15 GHz (Opt. 14) 200 MHz - 20 GHz (Opt. 14B) |

Resolution: 12 digits/s

■ Display:

Main Parameter: Period
Aux. Parameter(A, B): $V_{max}, V_{min}, V_{p-p}$

Frequency Burst A, B, C

Frequency and PRF of repetitive burst signals can be measured without external control signal and with selectable start arming delay.

Functions: Frequency in burst (Hz)
PRF (Hz)
Number of cycles in burst

Range A, B, C: See Frequency A, B, C

Min. Burst

Duration: 40 ns (80 ns > 160 MHz)

Min. No. of Pulses

in Burst (Inp A, B): 3 (6 above 160 MHz)
(Inp C): 3 x prescaler factor

PRF Range (see also Inp C spec): 0.5 Hz - 1 MHz

Start Delay: 10 ns - 2 s, resolution 10 ns

Range: ns

■ Display:

Main Parameter: Frequency in burst

Aux. Parameters: PRF & number of cycles in burst (Ch A or Ch B only)

Period A, B, C Average

■ Range:

| | |
|------------------|-----------------|
| Input A, B: | 2.5 ns - 500 s |
| Input C (3 GHz): | 330 ps - 10 ns |
| (8 GHz): | 125 ps - 3.3 ns |
| (15 GHz): | 72 ps - 5 ns |
| (20 GHz): | 50 ps - 5 ns |
| Resolution: | 12 digits/s |

■ Display:

Main Parameter: Frequency

Aux. Parameter (A B): $V_{max}, V_{min}, V_{p-p}$

Period A, B Single

Range A, B: 3.3 ns - 1000 s
Resolution: 100 ps

■ Display:

Main Parameter: Period
Aux. Parameters: Vmax, Vmin, Vp-p

Ratio A/B, B/A, C/A, C/B

Range: 10^{-9} to 10^{11} (one-pass measurement, values < 1 with reduced resolution)
Freq Range A,B: 100 Hz to 400 MHz
Freq Range C: Full input C range

■ Display:

Main Parameter: Ratio
Aux. Parameters: Freq 1, Freq 2

Time Interval A to B, B to A, A to A, B to B

Range (normal calculation): 0 ns to $+10^6$ s
Range (smart calculation): -10^6 to $+10^6$ s
Resolution
Single Shot: 100 ps
Input Frequency: Lp to 160 MHz
Min. Pulse Width: 1.6 ns
Smart Calculation: Smart Time Int. w. 4 time stamps (2 consecutive Trig A plus 2 consecutive Trig B) to determine sign (A before B or A after B)

■ Display:

Main Parameter: Time interval
Aux. Parameters: None

Pulse Width A, B

Range: 2.5 ns - 10^6 s
Input Frequency: Lp to 200 MHz
Modes: Pos. pulse width or neg. pulse width

■ Display:

Main Parameter: Pulse width
Aux. Parameters: Vmax, Vmin, Vp-p

Rise and Fall Time A, B

Range: 1.5 ns - 1000 s
Input Frequency: Lp to 160 MHz (square wave)
Trigger Levels: Default 10% and 90% Manually adjustable
Min. Pulse Width: 1.6 ns
Modes: Rise or fall time
Min. Amplitude: 100 mVp-p

■ Display:

Main Parameter: Rise or fall time
Aux. Parameters: Slew rate, Vmax, Vmin

Phase A Rel. B, B Rel. A

Range: -180° to +360°
 Resolution: 0.001° to 10 kHz 0.01° to 1 MHz 0.1° to 10 MHz 1°
 >10 MHz Resolution can be improved by averaging (Statistics)
 Input Frequency: Up to 160 MHz
 Min. Pulse Width: 1.6 ns

■ Display:

Main Parameter: Phase
 Aux. Parameters: Freq (prim. channel),
 VA/VB (in dB)

Duty Factor A, B

Range: 0.000001 to 0.999999
 Input Frequency 0.1 Hz - 200 MHz
 Min. Pulse Width 2.5 ns
 Modes: Pos. or neg. duty factor

■ Display:

Main Parameter: Duty factor
 Aux. Parameters: Period, pulse width

Vmax, Vmin, Vp-p A, B

Alternative data within parentheses refer to input attenuator setting x10.

Range: -5 V to +5 V (-50 V to +50 V)
 Input Frequency: DC, 1Hz - 300 MHz,
 100 Hz - 300 MHz default
 (higher LF limit means higher meas. speed)

Mode: V max, V min, V p-p*
 Resolution: 3 (30) mV

Accuracy (typ.):*

| | |
|----------------|-------------------|
| DC | 1% ± 15 (150) mV |
| 1 Hz - 1 kHz | 1% ± 15 (150) mV |
| 1 kHz - 20 MHz | 3% ± 15 (150) mV |
| 20 - 100 MHz | 10% ± 15 (150) mV |
| 100 - 300 MHz | 30% ± 15 (150) mV |

* V_{p-p} is calculated as V_{max} - V_{min}, which means that the maximum absolute error will be ±30 (300) mV.

■ Display:

Main Parameter: Vmax or Vmin or Vp-p
 Aux Parameters: V min, V p-p or
 V max, V p-p or
 V min/V max

Timestamping A, B, C

This function is only accessible via GPIB or USB.

No absolute time exists, timestamp values can only be used for relative time measurements.

Timestamps are taken of two consecutive positive edges and two consecutive negative edges (pos, neg, pos, neg or neg, pos, neg, pos) and the number of positive edges is counted.

Max. Frequency: 160 MHz
 Min. Pulse Width: 2.5 ns
 Timestamp Resolution: 70 ps rms
 Max. Frequency to catch each edge: 250 kHz

Auto Set / Manual Set

All measuring functions can be auto-set using best settings for the individual functions. This means e.g. an auto hysteresis of 40% of Vp-p in frequency measurements, an auto trigger at 50% of Vp-p with minimum hysteresis incl. hysteresis compensation in time measurements, an auto find of burst length and auto sync for frequency burst measurements, etc.

NOTE: The frequency range for inputs A & B, is up to 300 MHz for Auto trig, and up to 400 MHz for Manual trig

Input and Output Specifications

Inputs A and B

Alternative data within parentheses refer to input attenuator setting x10.

Frequency Range

DC-coupled: DC - 400 MHz
 AC-coupled: 10 Hz-400 MHz
 Coupling: AC or DC
 Rise Time: Approx. 700 ps
 Impedance: 1 M Ω / 25 pF or 50 Ω (VSWR < 2)

Trigger Slope: Positive or negative
 Channels: Separate A & B

Max. Channel

Timing

Difference: 500 ps

Hysteresis

Window: Approx. 30 (300) mVp-p

Residual Hyster-

esis after Com-

ensation:

5 (50) mV (DC - 10 kHz)

Sensitivity

DC - 200 MHz: 15 mVrms

200 - 300 MHz: 25 mVrms

300 - 400 MHz: 35 mVrms

Auto Trig: 35 mVrms

Attenuation: x1, x10

Dynamic Range: 30 mVp-p to 10 Vp-p within

(x1): ± 5 V window

Trigger Level: Read-out on display

Resolution: 3 (30) mV

Uncertainty: ± 15 (150) mV $\pm 1\%$ of trigger level

Auto trig: Automatically set to 50% of input signal (10% and 90% for rise/fall time). Relative level (in %) manually adjustable when necessary.

Auto Hysteresis: Minimum hysteresis window

| | |
|--------------------------------|--|
| Time Meas. : | (+compensation) |
| Freq. Meas. & Per. Avg.: | 70 % and 30 % of input signal. Minimum hysteresis window if arming on A or B is activated. |
| Freq. Range: | up to 300 MHz |
| Analog Noise Reduction Filter: | Nom. 100 kHz, RC type |
| Digital LP Filter: | 1 Hz - 50 MHz using trigger hold-off |
| Trigger Indicators: | LED |
| Max. Voltage w/o Damage | |
| 1 M Ω | 350 V (DC+ ACpk)@DC to 440 Hz, falling to 12 VRMS (x1) and 120 VRMS (x10) @ 1 MHz |
| 50 Ω | 12 VRMS |

Input C (Option 10)

| | |
|-------------------------------|---|
| Freq. Range: | 100 MHz - 3.0 GHz |
| Prescaler Factor: | 16 |
| Operating Input Voltage Range | |
| 100 - 300 MHz: | 20 mVrms -12 Vrms |
| 0.3-2.5 GHz: | 10 mVrms -12 Vrms |
| 2.5-2.7 GHz: | 20 mVrms -12 Vrms |
| 2.7-3.0 GHz | 40 mVrms -12 Vrms |
| Amplitude Modulation | |
| DC - 0.1 MHz Modulation | |
| Frequency: | Up to 94% depth |
| 0.1-6 MHz Modulation | |
| Frequency: | Up to 85% depth Min. signal must exceed min. oper. input voltage |
| Impedance: | 50 Ω nom. AC-coupled VSWR < 2.5:1 |
| Max. Voltage w/o Damage: | 12 Vrms, PIN diode prot. |

Connector: Type N female

Input C (Option 13)

| | |
|---------------------------------------|---|
| Freq. Range: | 300 MHz - 8 GHz |
| Prescaler Factor: | 256 |
| Operating input voltage range: | |
| 0.1 - 0.2 GHz | 100 mVrms - 7 V r m s |
| 0.2 - 0.3 GHz | 40 mVrms - 7 V r m s |
| 0.3 - 0.5 GHz | 20 mVrms - 7 V r m s |
| 0.5 - 3.0 GHz | 10 mVrms - 7 V r m s |
| 3.0 - 4.5 GHz | 20 mVrms - 7 V r m s |
| 4.5 - 6.0 GHz | 40 mVrms - 7 V r m s |
| 6.0 - 8.0 GHz | 80 mVrms - 7 V r m s |
| Amplitude Modulation | |
| DC-0.1 MHz Modulation | |
| Frequency: | Up to 94% depth |
| 0.1-6 MHz Modulation | |
| Frequency: | Up to 85% depth Min. signal must exceed min. oper. input voltage |
| Impedance: | 50 Ω nom. AC-coupled VSWR < 2.5:1 |
| Max. Voltage w/o Damage: | 7 Vrms, PIN diode protected |
| Connector: | Type N female |
| Input C (Options 14 & 14B) | |
| Freq. Range: | 250 MHz - 15 GHz (14) 250 MHz - 20 GHz (14B) |
| Prescaler Factor: | 128 |
| Operating input voltage range: | |
| 0.25 - 0.5 GHz | -21 to +27 dBm |
| 0.5 - 15 GHz | -27 to +27 dBm |
| 14 - 17 GHz | -27 to +27 dBm (14B) |
| 17 - 20 GHz | -21 to +27 dBm (14B) |

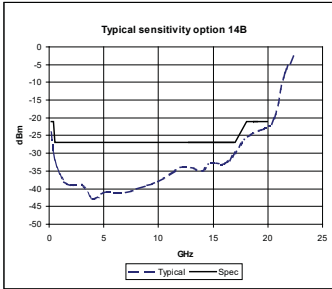

AM tolerance: - Up to 90% depth
 Burst
 Minimum
 Burst Length: Period x 257
 Minimum Interval
 Between Bursts: 10 μ s
 Impedance: 50 Ω nom. AC-coupled
 VSWR < 2:1
 Max. Voltage w/o
 Damage: +27 dBm, PIN diode prot.
 Connector: Type N female

Rear Panel Inputs & Outputs

Ref. Input: 1, 5 or 10 MHz;
 0.1 - 5 V_{rms} sinewave;
 impedance > 1 k Ω
 Ref. Output: 1x10 MHz, >1 V_{rms} into
 50 Ω load
 Arming Input (E): Arming of all meas. func.
 Freq. Range: DC - 80 MHz
 Trigger Level: TTL, 1.4 V nom.
 Trigger Slope: Positive or negative
 Meas. Inputs: A, B, C (option)
 Impedance: 1 M Ω /50 pF or 50 Ω
 (VSWR \leq 2:1)
 Connectors: BNC (SMA for Input C)
 BNC (SMA for Input C)

Auxiliary Functions

Trigger Hold-Off

Time Delay
 Range: 20 ns - 2 s, 10 ns resol.

External Start/Stop Arming

Modes: Start arming, stop arming,
 start and stop arming
 Input Channels: A, B, E (EXT ARM)
 Max. Rep. Rate
 for Arming Signal
 Channel A, B: 160 MHz
 Channel E: 80 MHz
 Start Time Delay
 Range: 10 ns - 2 s, 10 ns resol.

NOTE: Stop arming has no delay setting.

Statistics

Functions: Maximum, minimum,
 mean, $\Delta_{max-min}$, standard
 deviation, Allan deviation
 Display: Numeric or numeric +
 graphic
 Graphic: Histogram & trend plot,
 auto scaled
 Sample Size: 2 to 2 x 10⁹
 Max. Sample
 Rate: 250 kSa/s measured,
 2 kSa/s calculated,
 depending on meas. function
 and graphics
 Limit Qualifier: Off
 Capture & store values above
 limit 2
 Capture & store values below

limit 1
 Capture & store values inside limits 1 and 2
 Capture & store values outside limits 1 and 2

Meas. Pacing
 Time Range: 2 μ s - 500 s
 Equidistancy: $\pm(2 \mu$ s + 0.1% of pacing time)

Mathematics

Functions: $K \cdot X + L$, $K/X + L$, $(K \cdot X + L)/M$, $(K/X + L)/M$ and $X/M - 1$

X is current reading. K, L and M are constants, set via keyboard or as frozen reference value (X_0).

Other Functions

Measuring Time: 20 ns - 1000 s for Period AVG, Frequency and PRF; 20 ns - 2 s for Freq. in Burst; Single cycle for other meas. functions. Times >2 s are software controlled w. reduced resolution and accuracy.

Timebase Reference: Internal, external or automatic

Display Hold: Freezes meas. result until a new measurement is initiated via Restart.

Digit Blanking: Removes (blanks) 1 to 13 digits from the calculated result before displaying it.

Limit Alarm: Annunciator on display and/or SRQ via GPIB

Limit Values: Lower limit (limit 1)

Upper limit (limit 2)
 Settings: Off
 Alarm if value > limit 2
 Alarm if value < limit 1
 Alarm if limit 1 < value < limit 2
 Alarm if value > limit 2 or value < limit 1
 On Alarm: Stop or Continue
 Display: Numeric + graphic
 Numeric: Current measurement value + annunciator for limit alarm
 Graphic: Horizontal line w. upper/lower limit markers + current value marker
 Stored Instrument Setups: 20 complete setups can be saved and recalled from internal non-volatile memory; 10 can be user protected

Display

Type & Use: Graphics screen for menu control, numerical readout (14 digits) and status info
 Resolution: 320 x 97 pixels
 Technology: Monochrome LCD with white LED backlight

GPIB Interface

Programmable
 Functions: All front panel accessible functions
 Compatibility: IEEE 488.2-1987, SCPI 1999
 Modes: Native mode
 Agilent compatible mode

Specifications

| | |
|------------------------|--|
| Agilent Compatibility: | HP 53131/132/181 commands are emulated. Code and response format is compatible. No timing compatibility. No resolution compatibility |
| Interface Functions: | SH1, AH1, T6, L4, SR1, RL1, DC1, DT1, E2 |
| Max. Meas. Rate | |
| Via GPIB: | 2000 readings/s (block) 350 readings/s (individual) |
| To Internal Memory: | 250 k readings/s |
| Internal Memory Size: | Up to 750 k readings |
| Data Output: | ASCII, IEEE double precision floating point |

USB Interface

| | |
|-----------|---------------|
| Version: | 2.0, 12 Mb/s |
| Protocol: | USBTMC-USB488 |

TimeView™

This software package is intended for advanced Modulation Domain analysis and runs on any 32-bit Windows® system.

■ Data Capture Modes & Measurement Rate

Effective rate depends on measurement function and internal data format.

Free-running

| | |
|----------------------|--|
| Measurement: | 250 k readings/s |
| Repetitive Sampling: | Up to 100 Msa/s equiv. sample rate (10 ns between samples) |

| | |
|---------------------------|--|
| Continuous Single Period: | Yes, from LF to 250 kHz repetition rate |
| Waveform Capture: | Yes |
| Data Analysis Features: | Measurement data vs time Cursor measurements Distribution histogram FFT graph w. Hamming, Hanning and other relevant filters Smoothing Zoom Setup, measurement data archive and printing Zero dead time ADEV and MADEV vs. τ |

Battery Unit

Option 23/90

| | |
|-----------------------------|---|
| Battery Type: | Li-Ion, 22.2 V, 90 Wh |
| Ext. DC Input: | 12 to 18 V, max 6 A |
| Connector: | XLR male, 3-pin |
| Oper. & Charg. Temp. Range: | 0 to +40 °C |
| Storage: | -20 to +60 °C (1 month) -20 to +45 °C (3 months) -20 to +20 °C (1 year) |

Operating Time

| | |
|-------------|---------------------------|
| (@ +25 °C): | ON: >4.5 h Stby: >24 h |
|-------------|---------------------------|

| | |
|-----------|--|
| Charging: | Automatic, when ext. AC or DC is connected |
|-----------|--|

Charging Time

| | |
|-------------------|----------------------------------|
| (@ +25 °C): | <8.5 h |
| Status Indicator: | On-screen w. low battery warning |

| | |
|---------|--------|
| Weight: | 1.2 kg |
|---------|--------|

Measurement Uncertainties

Random Uncertainties (1 σ)

Quantization Error (E_q)

$$E_q = 100 \text{ ps rms}$$

Start/Stop Trigger Error (E_{SS})

$$E_{SS} = \sqrt{E_{noise}^2 + E_{jitter}^2} \text{ (s)}$$

$$E_{noise} = \frac{\sqrt{V_{noise-input}^2 + V_{noise-signal}^2}}{inp. \text{ sign. slew rate (V/s) at trig. point}} \text{ (s)}$$

$$E_{jitter} = \text{Single Period Jitter (rms) (s)}$$

$$V_{noise-input}: \quad 500 \text{ uV}_{rms} \text{ internal noise (200 uV}_{rms} \text{ typical)}$$

$$V_{noise-signal}: \quad \text{The rms noise of the applied signal}$$

Systematic Uncertainties

Trigger Level Timing Error (E_{tl})

Time Interval, Rise/Fall Time, Pulse Width, Duty Factor, Phase (*attenuator setting xl*)

$$E_{tl} = \sqrt{[TLU + \frac{1}{2} * Hyst]^2 * [(\frac{1}{S_x})^2 + (\frac{1}{S_y})^2]} \text{ [s]}$$

where:

S_x = Slew rate at start trigger point (V/s) S_y =

Slew rate at stop trigger point (V/s) TLU =

Trigger level uncertainty (V) Hyst =

Hysteresis window (V)

Hyst = 30 mV \pm 1% of trig lvl (DC to 1 kHz)
for *Pulse Width & Duty Factor*

Hyst = 6 mV \pm 1 % of trig lvl (DC to 1 kHz)
for other measurement functions.

Timebase Error (TBE)

TBE is the relative error of the timebase oscillator (dimensionless) and depends on the actual oscillator used. See Timebase Options on page 8-15.

Total Uncertainty (2 σ)

The general formula for all measurement functions is:

$$U_{tot} = 2 * \sqrt{(rand. \text{ uncert.})^2 + (syst. \text{ uncert.})^2}$$

Time Interval, Pulse Width, Rise/Fall Time

Random Uncertainty (rms)

$$U_{rnd} = \sqrt{E_q^2 + (Start \text{ Trig. Error})^2 + (Stop \text{ Trig. Error})^2} \text{ [s]}$$

Systematic Uncertainty

$$U_{syst} = \sqrt{\frac{1}{3} * [E_{tl}^2 + (500 \text{ ps})^2 + (TBE * TIME)^2]}$$

where:

E_{tl} = trigger level timing error

500 ps = maximum channel difference

TBE = timebase error

TIME = measurement result

Frequency & Period

Random Uncertainty (rms)

For measuring times <200 ms and if *Smart Freq* = *AUTO* or *OFF*:

$$U_{rnd} = \frac{\sqrt{E_q^2 + 2 * (Start \text{ Trigger Error})^2}}{\text{Measuring Time}} \times$$

x Measurement Result [Hz or s]

For measuring times ≥ 200 ms and if *Smart Freq* = *AUTO* or *ON*:

$$U_{rnd} = \frac{2.5 \sqrt{E_q^2 + 2 * (Start\ Trigger\ Error)^2}}{Measuring\ Time * \sqrt{N}} \times$$

\times Measurement Result [Hz or s]

$N = 800 / Measuring\ Time$, however, $6 < N < 1000$ and

$N < (Freq/2) * Measuring\ Time - 2$

■ **Systematic Uncertainty**

$$U_{syst} = \sqrt{\gamma/3 * \{ [TBE * MR]^2 + [(200\ ps / MT) * MR]^2 \}} [Hz\ or\ s]$$

where:

MR = Meas. Result (Freq or Per)

MT = Meas. Time

Frequency Ratio f_1/f_2

■ **Typical Random Uncertainty (rms)**

NOTE. Frequency Ratio is an auxiliary measurement function, intended to give an indication, with no guaranteed specification.

$$U_{rnd} = 2 \times f_1 \times \sqrt{E_q^2 + E_{SS(f_1)}^2 + E_{SS(f_2)}^2}$$

[dimensionless, e.g. ppm]

Phase

■ **Typical Random Uncertainty (rms)**

NOTE. Phase is an auxiliary measurement function, intended to give an indication, with no guaranteed specification.

$$U_{rnd} = \sqrt{E_q^2 + (Start\ Trg\ Err)^2 + (Stop\ Trg\ Err)^2} \times Freq. \times 360 [^\circ]$$

■ **Systematic Uncertainty**

$$U_{syst} = \sqrt{\gamma/3 * [E_u^2 + (500\ ps)^2]} \times Freq \times 360 [^\circ]$$

Duty Factor

■ **Random Uncertainty (rms)**

$$U_{rnd} = \sqrt{E_q^2 + (Start\ Trg\ Err)^2 + (Stop\ Trg\ Err)^2} \times Freq.$$

or minimum: 1 ppm

■ **Systematic Uncertainty**

$$U_{syst} = \sqrt{\gamma/3 * [E_u^2 + (200\ ps)^2]} \times Freq$$

[dimensionless, e.g. ppm]

Calibration

| | |
|--|------------------------------------|
| Mode: | Closed case, menu-controlled. |
| Calibration Input: | A |
| Password | |
| Protection: | ON or OFF |
| Input Frequencies used for TB Calibration: | 1.0, 1.544, 2.048, 5.0 or 10.0 MHz |

Definition of Terms

Calibration Adjustment Tolerance:

The maximum tolerated deviation from the true 10 MHz frequency after calibration. If the timebase frequency does not exceed the tolerance limits at the moment of calibration, an adjustment is not necessary.

Total Uncertainty: The total possible deviation from the true 10 MHz frequency under influence of frequency drift due to aging and ambient temperature variations versus the reference temperature. The operating temperature range and the calibration interval are part of this specification.

See also timebase specifications on page 8-15.

General Specifications

Environmental Data

| | |
|--------------|---|
| Class: | MIL-PRF-28800F, Class 3 |
| Operat. Temp | 0 °C to +50 °C |
| Storage Temp | -40 °C to +71 °C |
| Humidity: | 5-95 % @ 10-30 °C 5-75 % @ 30-40 °C 5-45 % @ 40-50 °C |

| | |
|--------------------|--|
| Max. Altitude: | 4600 m |
| Vibration: | Random and sinusoidal per MIL-PRF-28800F, Class 3 |
| Shock: | Half-sine 30G per MIL-PRF-28800F; bench handling |
| Transit Drop Test: | Transport box tested according to UN-D 1400 drop test program 1. Heavy-duty transport case and soft carrying case tested according to MIL-PRF-28800F. |
| Reliability: | MTBF 30000 h, calculated Designed and tested for Measurement Category I, Pollution Degree 2, in accordance with EN/IEC 61010-1:2001 and CAN/CSA-C22.2 No. 61010-1-04 (incl. approval) |
| Safety: | |
| EMC: | EN 61326 (1997) A1 (1998), increased test levels per EN 50082-2, Group 1, Class B, CE |

Power Requirements

| | |
|---------------|-------------------------------|
| Line Voltage: | 100-240 Vac, 50-400 Hz (Nom.) |
| Power | |
| Consumption: | <40 W |

Dimensions & Weight

| | |
|---------|---|
| Width: | 1/2 x 19" (210 mm) |
| Height: | 2U (90 mm) |
| Depth: | 395 mm |
| Weight: | Net 2.7 kg (5.8 lb) Shipping 3.5 kg (7.5 lb) |

Ordering Information

Basic Model

| | |
|---------|---|
| CNT-90: | 400 MHz, 100 ps Timer/Counter including standard timebase and GPIB interface |
|---------|---|

Included with Instrument: 36 months product warranty, line cord, brochure with important information; 'getting started' manual, user's manual, and programmer's handbook on CD; Certificate of Calibration.

RF Input Options

| | |
|-------------|-----------------|
| Option 10: | 3.0 GHz Input C |
| Option 13: | 8 GHz Input C |
| Option 14: | 15 GHz Input C |
| Option 14B: | 20 GHz Input C |

Timebase Options

| | |
|---------------|--------------------------|
| Option 19/90: | Medium stability OCXO |
| Option 30/90: | Very high stability OCXO |
| Option 40/90: | Ultrahigh stability OCXO |

Optional Accessories

| | |
|---------------|---|
| Option 11/90: | Rear panel inputs |
| Option 22/90: | Rackmount kit |
| Option 23/90: | Battery supply unit Carrying case |
| Option 27: | Heavy-duty hard transport case |
| Option 27H: | TimeView for CNT-90, modulation domain analysis SW |
| Option 29/90: | Cal. certificate w. protocol; standard oscillator |
| Option 90/01: | Cal. certificate w. protocol; oven oscillator |
| Option 90/06: | Cal. certificate w. protocol; Hold-over frequency ag-ing/week |
| Option 90/00: | 5 years extended warranty |

Printed Manuals:

| | |
|-------------------------------|------------------------|
| CNT-90 & CNT-91(R) & CNT-90XL | Getting Started Manual |
| CNT-90 & CNT-91(R) & CNT-90XL | User's Manual |
| CNT-90 & CNT-91(R) & CNT-90XL | Programmer's Handbook |

Timebase Options

| Product Family | '9X' | | | | |
|--|-------------------------|-----------------------|-----------------------|------------------------|------------------------|
| | Option Timebase Type | Standard UCXO | Option 19/90 OCXO | Option 30/90 OCXO | Option 40/90 OCXO |
| Uncertainty due to: | | | | | |
| -Calibration adjustment tolerance @ +23 °C ± 3°C | | <1x10 ⁻⁶ | <5x10 ⁻⁸ | <1x10 ⁻⁸ | <3x10 ⁻⁹ |
| -Aging | | | | | |
| per 24 h | 1) | | 2)<5x10 ⁻⁹ | 2)<5x10 ⁻¹⁰ | 2)<3x10 ⁻¹⁰ |
| per month | | <5x10 ⁻⁷ | <6x10 ⁻⁸ | <1x10 ⁻⁸ | <3x10 ⁻⁹ |
| per year | | <5x10 ⁻⁶ | <2x10 ⁻⁷ | <5x10 ⁻⁸ | <1.5x10 ⁻⁸ |
| -Temperature variation: | | | | | |
| 0 °C - 50 °C | | <1x10 ⁻⁵ | <5x10 ⁻⁸ | <5x10 ⁻⁹ | <2.5x10 ⁻⁹ |
| 20 °C - 26 °C (typ. values) | | <3x10 ⁻⁶ | <2x10 ⁻⁸ | <1x10 ⁻⁹ | <4x10 ⁻¹⁰ |
| -Power voltage variation: ±10% | | <1x10 ⁻⁸ | <5x10 ⁻⁹ | <5x10 ⁻¹⁰ | <5x10 ⁻¹⁰ |
| Short term stability: | | | | | |
| (Root Allan Variance) | | | | | |
| τ = 1 s | not specified | | <1x10 ⁻¹⁰ | 1x10 ⁻¹¹ | 5x10 ⁻¹² |
| Typical values τ = 10 s | | | <1x10 ⁻¹⁰ | 1x10 ⁻¹¹ | 5x10 ⁻¹² |
| Power-on stability: | | | | | |
| -Deviation versus final value after 24 h on time, after a warm-up time of: | 1) | | | | |
| 30 min | | 30 min | <1x10 ⁻⁷ | <1x10 ⁻⁸ | <5x10 ⁻⁹ |
| 10 min | | 10 min | 30 min | 10 min | 10 min |
| Total uncertainty, for operating temperature 0°C to 50 °C, @ 2 σ (95 %) confidence interval: | | | | | |
| -1 year after calibration | | <1.2x10 ⁻⁵ | 2.4x10 ⁻⁷ | <6x10 ⁻⁸ | <1.8x10 ⁻⁸ |
| -2 years after calibration | | <1.5x10 ⁻⁵ | 4.6x10 ⁻⁷ | <1.2x10 ⁻⁷ | <3.6x10 ⁻⁸ |
| Typical total uncertainty, for operating temperature 20°C to 26 °C, @ 2 σ (95 %) confidence interval: | | | | | |
| -1 year after calibration | | <7x10 ⁻⁶ | <2.4x10 ⁻⁷ | <6x10 ⁻⁸ | <1.7x10 ⁻⁸ |
| -2 years after calibration | | <1.2x10 ⁻⁵ | <4.6x10 ⁻⁷ | <1.2x10 ⁻⁷ | <3.5x10 ⁻⁸ |

Explanations

- 1) Negligible in comparison with the deviation caused by 1 °C temperature change.
- 2) After 1 month of continuous operation.

NOTE: Electrical adjustment by means of tuning voltage from DAC; no potentiometer trimming.
Serial interface to all optional oscillators for closed-case calibration and status reporting.

UCXO: Uncompensated Crystal Oscillator

OCXO: Oven Controlled Crystal Oscillator

CNT-90XL

Introduction

Only values with tolerances or limits are guaranteed data. Values without tolerances are informative data, without guarantee.

Measurement Functions

Refer to page 8-24 for uncertainty information.

Inputs A and B can be swapped in all modes except **Rise Time** and **Fall Time**.

Display: All measurements are displayed with a large main parameter value and smaller auxiliary parameter values (with less resolution). Some measurements are only available as auxiliary parameters.

Frequency A, B, C

■ Range:

Input A: 0.002 Hz - 400 MHz
 Input B: 0.002 Hz - 400 MHz
 Input C: 0.3 - 27 GHz (CNT-90XL-27G)
 0.3 - 40 GHz (CNT-90XL-40G)
 0.3 - 46 GHz (CNT-90XL-46G)
 0.3 - 60 GHz (CNT-90XL-60G)

Acquisition Time: 25 ms in Auto (typ.)
 Resolution: 12 digits/s

Note: Some frequencies may not be acquired correctly with Auto Acquisition. If so, switch to Manual Acquisition instead.

■ Display:

Inputs A & B Main
 Parameter: Frequency
 Aux. Parameters: V_{max}, V_{min}, V_{p-p}
 Input C Main
 Parameter: Frequency
 Aux. Parameter: Power in dBm

Frequency Burst A, B

Frequency and PRF of repetitive burst signals can be measured without external control signal and with selectable start arming delay.

Functions: Frequency in burst (Hz)
 PRF (Hz)
 Number of cycles in burst
 Range A, B: See Frequency A, B
 Min. Burst
 Duration: 40 ns (80 ns > 160 MHz)
 Min. No. of Pulses
 in Burst: 3 (6 above 160 MHz)
 PRF Range: 0.5 Hz - 1 MHz
 Start Delay
 Range: 10 ns - 2 s, resolution
 10 ns

■ Display:

Main Parameter: Frequency in burst
 Aux. Parameters: PRF & number of cycles in burst (Ch A or Ch B only)

Period A, B, C Average

■ Range:

Input A, B: 3.3 ns - 500 s
 Input C (27 GHz): 37 ps - 3.3 ns
 (40 GHz): 25 ps - 3.3 ns
 (46 GHz): 22 ps - 3.3 ns
 (60 GHz): 17 ps - 3.3 ns
 Acquisition: Auto or Manual (within ±40 MHz)
 Acquisition Time: 25 ms in Auto (typ.)
 Resolution: 12 digits/s

■ Display:

Input A, B
 Main Parameter: Period
 Aux. Parameters: V_{max}, V_{min}, V_{p-p}
 Input C
 Main Parameter: Period
 Aux. Parameter: Power in dBm

Period A, B Single

Range A, B: 3.3 ns - 1000 s
 Resolution: 100 ps

■ Display:

Main Parameter: Period
 Aux. Parameters: V_{max}, V_{min}, V_{p-p}

Ratio A/B, B/A, C/A, C/B

Range: 10⁻⁹ to 10¹¹ (one-pass measurement, values < 1 with reduced resolution)
 Freq Range A,B: 100 Hz to 400 MHz
 Freq Range C: Full input C range

■ Display:

Main Parameter: Ratio
 Aux. Parameters: Freq 1, Freq 2

Time Interval A to B, B to A, A to A, B to B

Range (normal calculation): 0 ns to +10⁹ s
 Range (smart calculation): -10⁹ to +10⁹ s
 Resolution
 Single Shot: 100 ps
 Input Frequency: Up to 160 MHz
 Min. Pulse Width: 1.6 ns
 Smart Calculation: Smart Time Int. w. 4 time stamps (2 consecutive Trig A plus 2 consecutive Trig B) to determine sign (A before B or A after B)

■ **Display:**

Main Parameter: Time interval
 Aux. Parameters: None

Pulse Width A, B

Range: 2.5 ns - 10⁶ s
 Input Frequency: Up to 200 MHz
 Modes: Pos. pulse width or
 neg. pulse width

■ **Display:**

Main Parameter: Pulse width
 Aux. Parameters: V_{max}, V_{min}, V_{p-p}

Rise and Fall Time A, B

Range: 1.5 ns - 1000 s
 Input Frequency: Up to 160 MHz (square
 wave)

Trigger Levels: Default 10% and 90%
 Manually adjustable

Min. Pulse Width: 1.6 ns
 Modes: Rise or fall time
 Min. Amplitude: 100 mV_{p-p}

■ **Display:**

Main Parameter: Rise or fall time
 Aux. Parameters: Slew rate, V_{max}, V_{min}

Phase A Rel. B, B Rel. A

Range: -180° to +360°
 Resolution: 0.001° to 10 kHz
 0.01° to 1 MHz
 0.1° to 10 MHz
 1° > 10 MHz Resolution
 can be improved by
 averaging (Statistics)
 Up to 160 MHz

Input Frequency:
 Min. Pulse Width: 1.6 ns

■ **Display:**

Main Parameter: Phase
 Aux. Parameters: Freq (prim. channel),
 VA/VB (in dB)

Duty Factor A, B

Range: 0.000001 to 0.999999
 Input Frequency: 0.1 Hz - 200 MHz
 Min. Pulse Width: 2.5 ns
 Modes: Pos. or neg. duty factor

■ **Display:**

Main Parameter: Duty factor
 Aux. Parameters: Period, pulse width

V_{max}, V_{min}, V_{p-p} A, B

Alternative data within parentheses refer to
 input attenuator setting x10.

Range: -5 V to +5 V
 (-50 V to +50 V)

Input Frequency: DC, 1Hz - 300 MHz,
 100 Hz - 300 MHz default
 (higher LF limit means
 higher meas. speed)

Mode: V_{max}, V_{min}, V_{p-p}*
 Resolution: 3 (30) mV
 Accuracy (typ.):

| | |
|----------------|-------------------|
| DC | 1% ± 15 (150) mV |
| 1 Hz - 1 kHz | 1% ± 15 (150) mV |
| 1 kHz - 20 MHz | 3% ± 15 (150) mV |
| 20 - 100 MHz | 10% ± 15 (150) mV |
| 100 - 300 MHz | 30% ± 15 (150) mV |

* V_{p-p} is calculated as V_{max} - V_{min}, which
 means that the maximum absolute error will
 be ±30 (300) mV.

■ **Display:**

Main Parameter: V_{max} or V_{min} or V_{p-p}
 Aux Parameters: V_{min}, V_{p-p} or V_{max},
 V_{p-p} or V_{min}, V_{max}

Power C

Range:

Power: -35 to +10 dBm
 Frequency: 0.3 to 27, 40, 46
 or 60 GHz dep. on model

Resolution: 0.01 dBm @100 ms measuring
 time

Accuracy: ±1 dBm typ. to 27 GHz
 ±2 dBm typ. to 40 GHz
 ±3 dBm typ. to 60 GHz

Acquisition: Auto or Manual
 (within ±40 MHz)

Acquisition Time: 20 to 30 ms in Auto (typ.)
 Aux. Parameter: Frequency C

Pulsed RF parameters input C

(Option 28 only)

Frequency range: 0.3 to 27/40/46/60 GHz

Pulse ON voltage range:

0.4 to 40 GHz: -15 dBm to +13 dBm

(-20 dBm typ. to +13 dBm)

40 to 46 GHz: -10 dBm (typ.) to +13 dBm

46 to 60 GHz: 0 dBm (typ.) to +10 dBm

Min ON/OFF ratio: 15 dB

Pulse Width

Range: 30 ns to 1 sec.

Resolution: 200 ps rms

Accuracy: <10 ns+TBE*P_width

PRI (pulse repetition interval)

Range: 60 ns to 1 sec.

Resolution: 200 ps rms

Accuracy: <2 ns +TBE*PRI*

PRF (pulse repetition frequency)

Range: 1 Hz to 16.7 MHz (20 MHz typ.)

Resolution: (200ps/Meas_time)*PRF Hz

Frequency in Burst

Range: 400 MHz to 60 GHz

Pulse width: down to 100 ns

Resolution: (50ps/√N/Gate_time)*FREQ Hz*

Acquisition: Manual

Peak Power in Burst

Range: -20dBm to +10 dBm

Pulse width: down to 50 us

Acquisition: Manual

Resolution: 0.1 dBm < 1ms pulse

0.01 dBm > 1ms pulse

* N = number of RF pulses during total measurement

* TBE=number of RF pulses during total measurement (e.g. 6E-8)

* Gate=meas. time inside each RF pulse

Timestamping A, B

This function is only accessible via GPIB or USB.

No absolute time exists, timestamp values can only be used for relative time measurements.

Timestamps are taken of two consecutive positive edges and two consecutive negative edges (pos, neg, pos, neg or neg, pos, neg, pos) and the number of positive edges is counted.

Max. Frequency: 160 MHz

Min. Pulse Width: 2.5 ns

Timestamp

Resolution: 70 ps rms

Max. Frequency to

catch each edge: 250 kHz

Auto Set / Manual Set A, B

All measuring functions can be auto-set using best settings for the individual functions. This means e.g. an auto hysteresis of 40% of Vp-p

in frequency measurements, an auto trigger at 50 % of Vp.p with minimum hysteresis incl. hysteresis compensation in time measurements, an auto find of burst length and auto sync for frequency burst measurements, etc.

NOTE: The frequency range for inputs A & B, is up to 300 MHz for Auto trig, and up to 400 MHz for Manual trig

Input and Output Specifications

Inputs A and B

Alternative data within parentheses refer to input attenuator setting x10.

Frequency Range

DC-coupled: DC - 400 MHz
 AC-coupled: 10 Hz-400 MHz
 Coupling: AC or DC
 Rise Time: Approx. 700 ps
 Impedance: 1 M Ω /25 pF or 50 Ω (VSWR < 2)

Trigger Slope: Positive or negative
 Channels: Separate A & B

Max. Channel

Timing Difference: 500 ps

Hysteresis

Window: Approx. 30 (300) mVp-p

Residual Hysteresis after

Compensation: 5 (50) mV (DC - 10 kHz)

Sensitivity

DC - 200 MHz: 15 mVrms

200 - 300 MHz: 25 mVrms

300 - 400 MHz: 35 mVrms

Auto Trig: 35 mVrms

Attenuation: x1, x10

Dynamic Range

(x1): 30 mVp-p to 10 Vp-p within ± 5 V window

Trigger Level Read-out on display

Resolution: 3 (30) mV

Uncertainty: ± 15 (150) mV ± 1 % of trigger level

Auto trig: Automatically set to 50% of input signal (10% and 90% for rise/fall time).

Relative level (in %) manually adjustable when necessary.

Auto Hysteresis Minimum hysteresis window

Time Meas. : (+compensation)

Freq. Meas. & 70 % and 30 % of input signal

Per. Avg.: Minimum hysteresis window if

arming on A or B is activated. up to 300 MHz

Freq. Range:

Analog Noise

Reduction Filter: Nom. 100 kHz, RC type

Digital LP Filter: 1 Hz - 50 MHz using trigger hold-off

Trigger Indicators: LED

Max. Voltage w/o

Damage

1 M Ω 350 V (DC+ ACpk) @ D C to

440 Hz, falling to 12 V_{RMS} (x1)

and 120 V_{RMS} (x10) @ 1 MHz

12 V_{RMS}

50 Ω

Input C

| | |
|-----------------------------|---|
| Freq. Range: | 0.3 - 27 GHz (-27G) 0.3 - 40 GHz (-40G) 0.3 - 46 GHz (-46G) 0.3 - 60 GHz (-60G) |
| Operating Input Power Range | |
| 0.3 - 18 GHz: | -33 to +13 dBm |
| 18 - 20 GHz: | -29 to +13 dBm |
| 20 - 27 GHz: | -27 to +13 dBm |
| 27 - 40 GHz: | -23 to +13 dBm |
| 40 - 46 GHz: | -17 to +13 dBm |
| 46 - 60 GHz: | -15 to +10 dBm |
| AM Tolerance: | Any modulation index as long as the minimum signal amplitude exceeds the sensitivity limit. |
| FM Tolerance | 50 MHz _{pp} @ f>3.5 GHz |
| Man: | 30 MHz _{pp} @ f<3.5 GHz |
| Auto: | 20 MHz _{pp} for modulation frequency >0.1 MHz |
| Impedance: | 50 Ω nom. AC-coupled |
| VSWR: | <2.0:1@0.3-27 GHz (typ.) <2.5:1@27-46 GHz (typ.) <3.0:1@46-60 GHz (typ.) |
| Max. Power w/o Damage: | +25 dBm |
| O-load indicator: | ON @ Pin > +10dBm |
| Connectors ¹ : | SMA (-27G) 2.92 mm (-40G & -46G) 1.85 mm (-60G) |

Note:
¹ all field replaceable female 'sparkplugs'

Rear Panel Inputs & Outputs

| | |
|-------------------|--|
| Ref. Input: | 1, 5 or 10 MHz; 0.1 - 5 V _{rms} sinewave; impedance >1 kΩ |
| Ref. Output: | 1x10 MHz, >1 V _{rms} into 50 Ω load |
| Arming Input (E): | Arming of all meas. func. |
| Freq. Range: | DC - 80 MHz |
| Trigger Level: | TTL, 1.4 V nom. |
| Trigger Slope: | Positive or negative |

Auxiliary Functions

Trigger Hold-Off

| | |
|------------|---------------------------|
| Time Delay | |
| Range: | 20 ns - 2 s, 10 ns resol. |

External Start/Stop Arming

| | |
|----------------------------------|--|
| Modes: | Start arming, stop arming, start and stop arming |
| Input Channels: | A, B, E (EXT ARM) |
| Max. Rep. Rate for Arming Signal | |
| Channel A, B: | 160 MHz |
| Channel E: | 80 MHz |
| Start Time Delay | |
| Range: | 10 ns - 2 s, 10 ns resol. |

NOTE: Stop arming has no delay setting.

Statistics

| | |
|-------------------|--|
| Functions: | Maximum, minimum, mean $\Delta_{\max-\min}$, standard deviation Allan deviation |
| Display: | Numeric or numeric + graphic |
| Graphic: | Histogram & trend plot, auto scaled |
| Sample Size: | 2 to 2 x 10 ⁹ |
| Max. Sample Rate: | 250 kSa/s measured, 2 kSa/s calculated, depending on meas. function and graphics |

| | |
|------------------|--|
| Limit Qualifier: | Off Capture & store values above limit 2 Capture & store values below limit 1 Capture & store values inside limits 1 and 2 Capture & store values outside limits 1 and 2 |
| Meas. Pacing | |
| Time Range: | 2 μs - 500 s |
| Equidistancy: | ±(2 μs + 0.1% of pacing time) |

Mathematics

| | |
|------------|---|
| Functions: | K*X+L, K/X+L, (K*X+L)/M, (K/X+L)/M and X/M-1 X is current reading, K, L and M are constants, set via keyboard or as frozen reference value (X ₀). |
|------------|---|

Other Functions

| | |
|-----------------|--|
| Measuring Time: | 20 ns - 1000 s for Period AVG, Frequency and PRF, 20 ns - 2 s for Freq. in Burst; Single cycle for other meas. functions. Times >2 s are software controlled w. reduced resolution and accuracy. |
|-----------------|--|

| | |
|---------------------------|--|
| Timebase Reference: | Internal, external or automatic |
| Display Hold: | Freezes meas. result until a new measurement is initiated via Restart. |
| Digit Blanking: | Removes (blanks) 1 to 13 digits from the calculated result before displaying it. |
| Limit Alarm: | Annunciator on display and/or SRQ via GPIB |
| Limit Values: | Lower limit (limit 1) Upper limit (limit 2) |
| Settings: | Off Alarm if value > limit 2 Alarm if value < limit 1 Alarm if limit 1 < value < limit 2 Alarm if value > limit 2 or value < limit 1 |
| On Alarm: | Stop or Continue |
| Display: | Numeric + graphic |
| Numeric: | Current measurement value + annunciator for limit alarm |
| Graphic: | Horizontal line w. upper/lower limit markers + current value marker |
| Stored Instrument Setups: | 20 complete setups can be saved and recalled from internal non-volatile memory; 10 can be user protected |

Display

| | |
|-------------|---|
| Type & Use: | Graphics screen for menu control, numerical readout (14 digits) and status info |
| Resolution: | 320 x 97 pixels |
| Technology: | Monochrome LCD with white LED backlight |

GPIB Interface

| | |
|-------------------------|--|
| Programmable Functions: | All front panel accessible functions |
| Compatibility: | IEEE 488.2-1987, SCPI 1999 |
| Modes: | Native mode |
| Agilent Compatibility: | Agilent compatible mode |
| | HP 53131/132/181 commands are emulated. Code and response format is compatible. No timing compatibility. No resolution compatibility |
| Interface Functions: | SH1, AH1, T6, L4, SR1, RL1, DC1, DT1, E2 |
| Max. Meas. Rate | |
| Via GPIB: | 2000 readings/s (block) 350 readings/s (individual) |
| To Internal Memory: | 250 k readings/s |
| Internal Memory Size: | 250 k readings/s |
| Data Output: | Up to 750 k readings ASCII, IEEE double precision floating point |

USB Interface

| | |
|-----------|---------------|
| Version: | 2.0, 12 Mb/s |
| Protocol: | USBTMC-USB488 |

TimeView™

This software package is intended for advanced Modulation Domain analysis and runs on any 32-bit Windows® system.

■ Data Capture Modes & Measurement Rate

Effective rate depends on measurement function and internal data format.

| | |
|---------------------------|---|
| Free-running Measurement: | 250 k readings/s |
| Repetitive Sampling: | Up to 100 Msa/s equiv sample rate (10 ns between samples) |

| | |
|---------------------------|---|
| Continuous Single Period: | Yes, from LF to 250 kHz repetition rate |
|---------------------------|---|

| | |
|-------------------------|--|
| Waveform Capture: | Yes |
| Data Analysis Features: | Measurement data vs time Cursor measurements Distribution histogram FFT graph w. Hamming, Hanning and other relevant filters Smoothing Zoom Setup, measurement data archive and printing Zero dead time ADEV and MADEV vs. τ |

Battery Unit

Option 23/90

| | |
|-----------------------------|---|
| Battery Type: | Li-Ion, 22.2 V, 90 Wh |
| Ext. DC Input: | 12 to 18 V, max 6 A |
| Connector: | XLR male, 3-pin |
| Oper. & Charg. Temp. Range: | 0 to +40 °C |
| Storage: | -20 to +60 °C (1 month) -20 to +45 °C (3 months) -20 to +20 °C (1 year) |

| | |
|----------------------------|---------------------------|
| Operating Time (@ +25 °C): | ON: >4.5 h Stby: >24 h |
|----------------------------|---------------------------|

| | |
|-----------|--|
| Charging: | Automatic, when ext. AC or DC is connected |
|-----------|--|

| | |
|---------------------------|----------------------------------|
| Charging Time (@ +25 °C): | <8.5 h |
| Status Indicator: | On-screen w. low battery warning |

| | |
|---------|--------|
| Weight: | 1.2 kg |
|---------|--------|

Measurement Uncertainties

Random Uncertainties (1σ)

■ Quantization Error (Eq)

$$E_q = 100 \text{ ps rms}$$

■ Start/Stop Trigger Error (Ess)

$$E_{SS} = \sqrt{E_{noise}^2 + E_{jitter}^2} (s)$$

$$E_{noise} = \frac{\sqrt{V_{noise-input}^2 + V_{noise-signal}^2}}{inp. \text{ sign. slew rate } (\frac{V}{\mu s}) \text{ at trig. point}} (s)$$

$$E_{jitter} = \text{Single Period Jitter (rms) (s)}$$

V_{noise-input}: 500 μV_{rms} internal noise
(200 μV_{rms} typical)

V_{noise-signal}: The rms noise of the applied signal

Systematic Uncertainties

■ Trigger Level Timing Error (E_t)

Time Interval, Rise/Fall Time, Pulse Width, Duty Factor, Phase (attenuator setting x)

$$E_t = \sqrt{[TLU + \frac{1}{2} * Hyst]^2 * [(\frac{1}{S_x})^2 + (\frac{1}{S_y})^2]} [s]$$

where:

S_x = Slew rate at start trigger point (V/s)

S_y = Slew rate at stop trigger point (V/s)

TLU = Trigger level uncertainty (V)

Hyst = Hysteresis window (V)

Hyst = 30 mV ± 1% of trig lvl (DC to 1 kHz)

for *Pulse Width & Duty Factor*

Hyst = 6 mV ± 1% of trig lvl (DC to 1 kHz)

for other measurement functions.

■ Timebase Error (TBE)

TBE is the relative error of the timebase oscillator (dimensionless) and depends on the actual oscillator used. See Timebase Options on page 8-29.

Total Uncertainty (2σ)

The general formula for all measurement functions is:

$$U_{tot} = 2 * \sqrt{(rand. \text{ uncert.})^2 + (syst. \text{ uncert.})^2}$$

Time Interval, Pulse Width, Rise/Fall Time

■ Random Uncertainty (rms)

$$U_{rnd} = \sqrt{E_q^2 + (Start \text{ Trig. Error})^2 + (Stop \text{ Trig. Error})^2}$$

[s]

■ Systematic Uncertainty

$$U_{syst} = \sqrt{\frac{1}{3} * [E_{t0}^2 + (500 \text{ ps})^2 + (TBE * TIME)^2]}$$

where:

E_{t0} = trigger level timing error

500 ps = maximum channel difference

TBE = timebase error

TIME = measurement result

Frequency & Period A, B

■ Random Uncertainty (rms)

For measuring times <200 ms and if *Smart Freq = AUTO or OFF*:

$$U_{rnd} = \frac{\sqrt{E_q^2 + 2 * (Start \text{ Trigger Error})^2}}{\text{Measuring Time}} \times$$

x *Measurement Result* [Hz or s]

For measuring times >=200 ms and if *Smart Freq = AUTO or ON*:

$$U_{rnd} = \frac{2.5 * \sqrt{E_q^2 + 2 * (Start \text{ Trigger Error})^2}}{\text{Measuring Time} * \sqrt{N}} \times$$

x *Measurement Result* [Hz or s]

N = 800 / *Measuring Time*, however, 6 < N <

1000 and

N < (*Freq*/2) * *Measuring Time* - 2

■ Systematic Uncertainty

$$U_{syst} = \sqrt{\frac{1}{3} * \{ [TBE * MR]^2 + [(200 \text{ ps} / MT) * MR]^2 \}}$$

[Hz or s]

where:

MR = Meas. Result (Freq or Per)

MT = Meas. Time

Frequency & Period C

■ Random Uncertainty (rms)

$$U_{rnd} = \sqrt{\left(\frac{0.01}{MT}\right)^2 + \left(\frac{F * 50 \text{ ps}}{MT}\right)^2}$$

where:

F = Meas. Result expressed as frequency rounded up to the nearest whole GHz.

Example: 14.2... GHz should be inserted as 15*10⁹

■ Systematic Uncertainty

$$U_{syst} = \sqrt{\frac{1}{3} * (TBE * F)^2 + \frac{1}{3} * \left(\frac{0.02}{MT}\right)^2}$$

F is calculated as under *Random Uncertainty* above.

Frequency Ratio f_A/f_B or f_B/f_A

■ Typical Random Uncertainty (rms)

NOTE: Frequency Ratio is an auxiliary measurement function, intended to give an indication, with no guaranteed specification.

$$U_{rnd} = 2 \times f_i \times \sqrt{E_q^2 + E_{SS(f_i)}^2 + E_{SS(f_j)}^2}$$

[dimensionless, e.g. ppm]

f_i is the higher of the two frequencies.

Frequency Ratio f_c/f_A or f_c/f_B

NOTE: See preceding note.

■ Typical Random Uncertainty (rms)

$$U_{rnd} = \frac{f_{A,B}}{2} \sqrt{0.01^2 + (f_c \cdot 25 \text{ ps})^2 + f_{A,B}^2 (E_q^2 + 2E_{trg}^2)}$$

where:

E_{trg} = Trigger Error

Phase

■ Typical Random Uncertainty (rms)

NOTE: Phase is an auxiliary measurement function, intended to give an indication, with no guaranteed specification.

$$U_{rnd} = \sqrt{E_q^2 + (Strt \text{ Trg Err})^2 + (Stop \text{ Trg Err})^2} \times \text{Freq} \times 360 [^\circ]$$

■ Systematic Uncertainty

$$U_{sys} = \sqrt{1/3 \cdot [E_d^2 + (500 \text{ ps})^2]} \times \text{Freq} \times 360 [^\circ]$$

Duty Factor

■ Random Uncertainty (rms)

$$U_{rnd} = \sqrt{E_q^2 + (Strt \text{ Trg Err})^2 + (Stop \text{ Trg Err})^2} \times \text{Freq.}$$

or minimum: 1 ppm

■ Systematic Uncertainty

$$U_{sys} = \sqrt{1/3 \cdot [E_d^2 + (200 \text{ ps})^2]} \times \text{Freq}$$

[dimensionless, e.g. ppm]

Calibration

Mode: Closed case, menu-controlled.

Calibration Input: A

Password

Protection: ON or OFF

Input

Frequencies

used for TB

Calibration: 1.0, 1.544, 2.048, 5.0 or 10.0 MHz

Definition of Terms

Calibration Adjustment Tolerance: The maximum tolerated deviation from the true 10 MHz frequency after calibration. If the timebase frequency does not exceed the tolerance limits at the moment of calibration, an adjustment is not necessary.

Total Uncertainty: The total possible deviation from the true 10 MHz frequency under influence of frequency drift due to aging and ambient temperature variations versus the reference temperature. The operating temperature range and the calibration interval are part of this specification.

See also timebase specifications on page 8-29.

General Specifications

Environmental Data

| | |
|----------------|--|
| Class: | MIL-PRF-28800F, Class 3 |
| Operat. Temp: | 0 °C to +50 °C |
| Storage Temp: | -40 °C to +71 °C |
| Humidity: | 5-95 % @ 10-30 °C 5-75 % @ 30-40 °C 5-45 % @ 40-50 °C |
| Max. Altitude: | 4600 m |
| Vibration: | Random and sinusoidal per MIL-PRF-28800F, Class 3 |
| Shock: | Half-sine 30G per MIL-PRF-28800F; bench handling |
| Transit Drop | |
| Test: | Transport box tested according to UN-D 1400 drop test program 1. Heavy-duty transport case and soft carrying case tested according to MIL-PRF-28800F. |
| Reliability: | MTBF 30000 h, calculated |
| Safety: | Designed and tested for Measurement Category I, Pollution Degree 2, in accordance with EN/IEC 61010-1:2001 and CAN/CSA-C22.2 No. 61010-1-04 (incl. approval) |
| EMC: | EN 61326 (1997) A1 (1998), increased test levels per EN 50082-2, Group 1, Class B, CE |

Power Requirements

| | |
|---------------|-------------------------------|
| Line Voltage: | 100-240 Vac, 50-400 Hz (Nom.) |
| Power | |
| Consumption: | <40 W |

Dimensions & Weight

| | |
|---------|---|
| Width: | % x 19" (210 mm) |
| Height: | 2U (90 mm) |
| Depth: | 395 mm |
| Weight: | Net 2.7 kg (5.8 lb) Shipping appr. 3.5 kg (7.5 lb) |

Ordering Information

Basic Models

| | |
|---------------|---|
| CNT-90XL-27G\ | 27 /40 /46 /60 GHz |
| 140G\46G\60G: | Microwave Frequency Counter/Analyzer including medium stability OCXO timebase |

| | |
|---------------------------|---|
| Included with Instrument: | 36 months product warranty, line cord, brochure with important information; 'getting started' manual, user's manual, and programmer's handbook on CD; Certificate of Calibration. |
|---------------------------|---|

RF Input Versions

| | |
|-------|----------------|
| -27G: | 27 GHz Input C |
| -40G: | 40 GHz Input C |
| -46G: | 46 GHz Input C |
| -60G: | 60 GHz Input C |

Timebase Options*

| | |
|---|--------------------------|
| Option 30/90: | Very high stability OCXO |
| Option 40/90: | Ultrahigh stability OCXO |
| * Option 19/90 Medium Stability OCXO timebase is the standard oscillator in all CNT-90XL models | |

Pulsed RF Option

| | |
|------------|------------------------|
| Option 28: | Pulsed RF measurements |
|------------|------------------------|

Optional Accessories

| | |
|---------------|--|
| Option 22/90: | Rackmount kit |
| Option 23/90: | Battery supply unit |
| Option 27: | Carrying case |
| Option 27H: | Heavy-duty hard transport case |
| Option 29/90: | TimeView modulation domain analysis SW for CNT-90XL |
| Option 90/01: | Cal. certificate w. protocol; standard oscillator |
| Option 90/06: | Cal. certificate w. protocol; oven oscillator |
| Option 90/00: | Cal. certificate w. protocol; hold-over frequency aging/week |
| Option 95/05: | 5 years extended warranty |

Printed Manuals:

| | |
|-------------|-------------------------|
| GS-90-DE * | Getting Started German |
| GS-90-ENG * | Getting Started English |
| GS-90-FR * | Getting Started French |
| OM-90 * | User's Manual |
| PM-90 * | Programmer's Handbook |
| SM-90 | Service Manual |

* Included as PDF-file upon shipment

Timebase Options

| Product Family | | | |
|---|-----------------------------------|------------------------------------|------------------------------------|
| Option Timebase Type | ¹ Option 19/90 OCXO | Option 30/90 OCXO | Option 40/90 OCXO |
| Uncertainty due to: | | | |
| -Calibration adjustment tolerance @ +23 °C ± 3 °C | <5x10 ⁻⁸ | <1x10 ⁻⁸ | <3x10 ⁻⁸ |
| -Aging | | | |
| per 24 h | ²⁾ <5x10 ⁻⁹ | ²⁾ <5x10 ⁻¹⁰ | ²⁾ <3x10 ⁻¹⁰ |
| per month | <6x10 ⁻⁸ | <1x10 ⁻⁸ | <3x10 ⁻⁸ |
| per year | <2x10 ⁻⁷ | <5x10 ⁻⁸ | <1.5x10 ⁻⁸ |
| -Temperature variation: | | | |
| 0 °C - 50 °C | <5x10 ⁻⁸ | <5x10 ⁻⁸ | <2.5x10 ⁻⁸ |
| 20 °C - 26 °C (typ. values) | <2x10 ⁻⁸ | <1x10 ⁻⁸ | <4x10 ⁻¹⁰ |
| -Power voltage variation: ±10% | <5x10 ⁻⁸ | <5x10 ⁻¹⁰ | <5x10 ⁻¹⁰ |
| Short term stability: | | | |
| (Root Allan Variance) | | | |
| τ = 1 s | <1x10 ⁻⁸ | 1x10 ⁻⁸ | 5x10 ⁻⁸ |
| Typical values τ = 10 s | <1x10 ⁻¹⁰ | 1x10 ⁻¹¹ | 5x10 ⁻¹² |
| Power-on stability: | | | |
| -Deviation versus final value after 24 h on time, after a warm-up time of: | <1x10 ⁻⁷ | <1x10 ⁻⁸ | <5x10 ⁻⁸ |
| 30 min | | 10 min | 10 min |
| Total uncertainty | | | |
| Operating temperature 0°C to 50 °C, | | | |
| @2σ (95 % confidence interval): | | | |
| -1 year after calibration | 2.4x10 ⁻⁷ | <6x10 ⁻⁸ | <1.8x10 ⁻⁸ |
| -2 years after calibration | 4.6x10 ⁻⁷ | <1.2x10 ⁻⁷ | <3.6x10 ⁻⁸ |
| Typical total uncertainty | | | |
| Operating temperature 20°C to 26 °C, | | | |
| @2σ (95 % confidence interval): | | | |
| -1 year after calibration | <2.4x10 ⁻⁷ | <6x10 ⁻⁸ | <1.7x10 ⁻⁸ |
| -2 years after calibration | <4.6x10 ⁻⁷ | <1.2x10 ⁻⁷ | <3.5x10 ⁻⁸ |

Explanations

¹⁾ Standard timebase oscillator in the CNT-90XL.

²⁾ After 1 month of continuous operation.

NOTE: Electrical adjustment by means of tuning voltage from DAC; no potentiometer trimming.

Serial interface to all optional oscillators for closed-case calibration and status reporting.

OCXO: Oven Controlled Crystal Oscillator

CNT-91(R)

Introduction

Only values with tolerances or limits are guaranteed data. Values without tolerances are informative data, without guarantee.

Measurement Functions

Refer to page 8-11 for uncertainty information.

Inputs A and B can be swapped in all modes except **Rise Time** and **Fall Time**.

Display: All measurements are displayed with a large main parameter value and smaller auxiliary parameter values (with less resolution). Some measurements are only available as auxiliary parameters.

Frequency A, B, C

■ Range:

| | |
|-------------|---|
| Input A: | 0.001 Hz - 400 MHz |
| Input B: | 0.001 Hz - 400 MHz |
| Input C: | 100 MHz - 3 GHz (Opt. 10) 300 MHz - 8 GHz (Opt. 13) 200 MHz - 15 GHz (Opt. 14) 200 MHz - 20 GHz (Opt. 14B) |
| Resolution: | 12 digits/s (smart frequency) 11 digits/s (normal and back-back) |

■ Display:

| | |
|-----------------------|--|
| Main Parameter: | Frequency |
| Aux. Parameter(A, B): | V _{max} , V _{min} , V _{p-p} |

Frequency Burst A, B, C

Frequency and PRF of repetitive burst signals can be measured without external control signal and with selectable start arming delay.

| | |
|----------------------------------|---|
| Functions: | Frequency in burst (Hz) PRF (Hz) Number of cycles in burst See Frequency A, B, C |
| Range A, B, C: | |
| Min. Burst | |
| Duration: | 40 ns (80 ns > 160 MHz) |
| Min. No. of Pulses | |
| in Burst (Inp A, B): | 3 (6 above 160 MHz) |
| (Inp C): | 3 x prescaler factor |
| PRF Range (see also Inp C spec): | 0.5 Hz - 1 MHz |
| Start Delay | |
| Range: | 10 ns - 2 s, resolution 10 ns |

■ Display:

| | |
|------------------|---|
| Main Parameter: | Frequency in burst |
| Aux. Parameters: | PRF & number of cycles in burst (Ch A or Ch B only) |

Period A, B, C Average

■ Range:

| | |
|------------------|-----------------|
| Input A, B: | 3.3 ns - 500 s |
| Input C (3 GHz): | 330 ps - 10 ns |
| (8 GHz): | 125 ps - 3.3 ns |
| (15 GHz): | 72 ps - 5 ns |
| (20 GHz): | 50 ps - 5 ns |
| Resolution: | 12 digits/s |

■ Display:

| | |
|-----------------------|--|
| Main Parameter: | Period |
| Aux. Parameter(A, B): | V _{max} , V _{min} , V _{p-p} |

Period A, B Single

Range A, B: 3.3 ns - 1000 s
 Resolution: 50 ps rms typical

■ Display:

Main Parameter: Period
 Aux. Parameters: V_{max} , V_{min} ,
 V_{p-p}

Period A, B Back-to-Back

Range A, B: 4 ns - 500 s
 Resolution: 50 ps rms typical

■ Display:

Main Parameter: Period
 Aux. Parameters: V_{max} , V_{min} ,
 V_{p-p}

Ratio A/B, B/A, C/A, C/B

Range: 10^{-9} to 10^{11} (one-pass
 measurement, values < 1 with
 reduced resolution)
 Freq Range A,B: 100 Hz to 400 MHz
 Freq Range C: Full input C range

■ Display:

Main Parameter: Ratio
 Aux. Parameters: Freq 1, Freq 2

Time Interval A to B, B to A, A to A,B to B

Range (normal calculation): 0 ns to $+10^6$ s
 Range (smart calculation): -10^6 to $+10^6$ s
 Resolution
 Single Shot: 50 ps rms typical
 Input Frequency: Up to 160 MHz
 Min. Pulse Width: 1.6 ns
 Smart Calculation: Smart Time Int. w. 4 time

stamps (2 consecutive Trig A plus 2 consecutive Trig B) to determine sign (A before B or A after B)

■ Display:

Main Parameter: Time interval
 Aux. Parameters: None

Pulse Width A, B

Range: 2.5 ns - 10^6 s
 Input Frequency: Up to 200 MHz
 Modes: Pos. pulse width or neg. pulse width

■ Display:

Main Parameter: Pulse width
 Aux. Parameters: V_{max} , V_{min} , V_{p-p}

Rise and Fall Time A, B

Range: 1.5 ns - 1000 s
 Input Frequency: Up to 160 MHz (square wave)
 Trigger Levels: Default 10% and 90%
 Manually adjustable
 Min. Pulse Width: 1.6 ns
 Modes: Rise or fall time
 Min. Amplitude: 100 mVp-p

■ Display:

Main Parameter: Rise or fall time
 Aux. Parameters: Slew rate, V_{max} , V_{min}

Time Interval Error (TIE) A, B

Normalized Period Back-to-Back measurements, calculated as:

$$TIE(k) = k \times T_{REF} - \sum_{i=1}^k T_i$$

T_i = individual period back-to-back and T_{REF} = reference period value.

| | |
|--------------|---|
| Range: | ±1x10 ⁷ s |
| Resolution: | 50 ps rms typical |
| Freq. Range: | 1 Hz to 250 MHz |
| Signal Type: | Clock only |
| Mode: | Auto or manual freq. set. |
| Auto Mode: | Measures freq. of the first two samples, rounded to 4 digits. |

■ Display:

Main parameter: TIE value
 Aux. parameter: Clock signal frequency

Phase A Rel. B, B Rel. A

| | |
|--------------------|--|
| Range: | -180° to +360° |
| Resolution: | 0.001° to 10 kHz 0.01° to 1 MHz 0.1° to 10 MHz 1° >10 MHz Resolution can be improved by averaging (Statistics) |
| Input Frequency | Up to 160 MHz |
| Min. Pulse Width | 1.6 ns |
| Smart Calculation: | One-pass meas. of time interval + single period between two continuous signals with frequency f ₁ & f ₂ , where f ₁ /f ₂ =N or !/N. N is an integer. The meas. is made with 4 time stamps, 2 consecutive trig. A + two consecutive trig. B to determine sign of phase. |

■ Display:

Main Parameter: Phase
 Aux. Parameters: Freq (prim. channel), VA/VB (in dB), based on peak-to-peak meas.

Duty Factor A, B

| | |
|--------------------|--|
| Range: | 0.000001 to 0.999999 |
| Input Frequency | 0.1 Hz - 200 MHz |
| Min. Pulse Width | 2.5 ns |
| Smart Calculation: | One-pass meas. of pulse width + single period, made with 3 time stamps, 2 consecutive pos trig A + 1 neg trig A. |
| Modes: | Pos. or neg. duty factor |

■ Display:

Main Parameter: Duty factor
 Aux. Parameters: Period, pulse width

Vmax, Vmin, Vp-p A, B

Alternative data within parentheses refer to input attenuator setting x10.

| | |
|--------|----------------------------------|
| Range: | -5 V to +5 V (-50 V to +50 V) |
|--------|----------------------------------|

Input Frequency: DC, 1 Hz - 300 MHz,
100 Hz - 300 MHz default

(higher LF limit means higher meas. speed)

Mode: V max, V min, V p-p*
Resolution: 1 (10) mV
*Accuracy (typ.):

| | |
|----------------|-------------------|
| DC | 1% ± 15 (150) mV |
| 1 Hz - 1 kHz | 1% ± 15 (150) mV |
| 1 kHz - 20 MHz | 3% ± 15 (150) mV |
| 20 - 100 MHz | 10% ± 15 (150) mV |
| 100 - 300 MHz | 30% ± 15 (150) mV |

* V_{p-p} is calculated as V_{max} - V_{min}, which means that the maximum absolute error will be ±30 (300) mV.

■ Display:

Main Parameter: V_{max} or V_{min} or V_{p-p}
Aux Parameters: V_{min}, V_{p-p} or V_{max},
V_{p-p} or V_{min}, V_{max}

Totalize A, B, A+B, A-B, A/B

Inp. Freq. A, B: 0 - 160 MHz
Inp. Freq. E (arm): 0 - 80 MHz
Range A, B: 0 to 2³²-1 (>4.2*10⁹)
*Main Parameters: A, B
*Calc. Parameters: A+B, A-B, A/B
Modes: Manual, Gated,
Start/Stop or Timed

* If A or B is the main parameter, A-B and A/B will be displayed as aux. parameters.

If one of the calculated parameters is the main parameter, A and B will be displayed as aux. parameters.

NOTE: MANUAL controlled by front panel push button HOLD/RUN. Statistics and pacing inhibited.

GATED, START/STOP and TIMED controlled by setting arming conditions on the free input channels. Statistics and pacing allowed.

Timestamping A, B

This function is only accessible via GPIB or USB.

No absolute time exists; timestamp values can only be used for relative time measurements.

Timestamps are taken of two consecutive positive edges and two consecutive negative edges (pos, neg, pos, neg or neg, pos, neg, pos) and the number of positive edges is counted.

Max. Frequency: 160 MHz

Min. Pulse Width: 2.5 ns

Timestamp Reso-

lution: 50 ps rms

Max. Frequency to

catch each edge: 250 kHz

Auto Set / Manual Set

All measuring functions can be auto-set using best settings for the individual functions. This means e.g. an auto hysteresis of 33% of V_{p-p} in frequency measurements, an auto trigger at 50 % of V_{p-p} with minimum hysteresis incl. hysteresis compensation in time measurements, an auto find of burst length and auto sync for frequency burst measurements, etc. NOTE: The frequency range for inputs A & B, is up to 300 MHz for Auto trig, and up to 400 MHz for Manual trig

Input and Output Specifications

Inputs A and B

Alternative data within parentheses refer to input attenuator setting x10.

Frequency Range

| | |
|-------------|------------------------------------|
| DC-coupled: | DC - 400 MHz |
| AC-coupled: | 10 Hz-400 MHz |
| Coupling: | AC or DC |
| Rise Time: | Approx. 700 ps |
| Impedance: | 1 M Ω /25 pF or 50 Ω |

| | |
|----------------|----------------------|
| Trigger Slope: | Positive or negative |
| Channels: | Separate A & B |

Max. Channel Timing

| | |
|-------------|--------|
| Difference: | 500 ps |
|-------------|--------|

| | |
|--------------------|------------------------------------|
| Hysteresis Window: | Approx. 30 (300) mV _{p-p} |
|--------------------|------------------------------------|

| | |
|---|-------------------------|
| Residual Hysteresis after Compensation: | 5 (50) mV (DC - 10 kHz) |
| Sensitivity | |

| | |
|----------------|----------------------|
| DC - 200 MHz: | 15 mV _{rms} |
| 200 - 300 MHz: | 25 mV _{rms} |
| 300 - 400 MHz: | 35 mV _{rms} |
| Auto Trig: | 35 mV _{rms} |
| Attenuation: | x1, x10 |

| | |
|---------------------|---|
| Dynamic Range (x1): | 30 mV _{p-p} to 10 V _{p-p} within ± 5 V window |
|---------------------|---|

| | |
|---------------------------|--|
| Trigger Level Resolution: | Read-out on display 1 (10) mV |
| Uncertainty: | ± 15 (150) m V \pm 1% of trigger level |

| | |
|------------|--|
| Auto trig: | Automatically set to 50% of input signal (10% and 90% for rise/fall time). |
|------------|--|

Relative level (in %) manually adjustable when necessary.

| | |
|------------------------------|---|
| Auto Hysteresis Time Meas. : | Minimum hysteresis window (+compensation) |
|------------------------------|---|

| | |
|--------------------------|--|
| Freq. Meas. & Per. Avg.: | 70 % and 30 % of input signal. Minimum hysteresis window if arming on A or B is activated. |
|--------------------------|--|

| | |
|--------------|---------------|
| Freq. Range: | up to 300 MHz |
| Analog Noise | |

| | |
|--------------------|--------------------------------------|
| Reduction Filter: | Nom. 100 kHz, RC type |
| Digital LP Filter: | 1 Hz - 50 MHz using trigger hold-off |

| | |
|---------------------|-----|
| Trigger Indicators: | LED |
|---------------------|-----|

Max. Voltage w/o Damage

| | |
|--------------|---|
| 1 M Ω | 350 V (DC+ AC _{pk}) @ D C to 440 Hz, falling to 12 V _{RMS} (x1) and 120 V _{RMS} (x10) @ 1 MHz |
|--------------|---|

| | |
|------------------------|-------------------------|
| 50 Ω Connector: | 12 V _{RMS} BNC |
|------------------------|-------------------------|

Input C (Option 10)

| | |
|-------------------------------|--|
| Freq. Range: | 100 MHz - 3.0 GHz |
| Prescaler Factor: | 16 |
| Operating Input Voltage Range | |
| 100 - 300 MHz: | 20 mV _{rms} - 12 V _{rms} |
| 0.3 - 2.5 GHz: | 10 m V rms - 12 V rms |
| 2.5 - 2.7 GHz: | 20 mV _{rms} - 12 V rms |
| 2.7-3.0 GHz | 40 mV _{rms} -12 V _{rms} |

Amplitude Modulation
 DC - 0.1 MHz
 Modulation Frequency: Up to 94% depth
 0.1 - 6 MHz Up to 85% depth
 Modulation Min. signal must exceed min. oper. input voltage
 Frequency: oper. input voltage
 Impedance: 50 Ω nom. AC-coupled VSWR <2.5:1

Max. Voltage w/o Damage: 12 Vrms, PIN diode prot.
 Connector: Type N female

Input C (Option 13)

Freq. Range: 300 MHz - 8 GHz
 Prescaler Factor: 256
 Operating input voltage range:
 0.2 - 0.3 GHz 40 mVrms - 7 Vrms
 0.3 - 0.5 GHz 20 mVrms - 7 Vrms
 0.5 - 3.0 GHz 10 mVrms - 7 Vrms
 3.0 - 4.5 GHz 20 mVrms - 7 Vrms
 4.5 - 6.0 GHz 40 mVrms - 7 Vrms
 6.0 - 8.0 GHz 80 mVrms - 7 Vrms

Amplitude Modulation
 DC-0.1 MHz
 Modulation Frequency: Up to 94% depth
 0.1-6 MHz Up to 85% depth
 Modulation Min. signal must exceed min. oper. input voltage
 Frequency: oper. input voltage
 Impedance: 50 Ω nom. AC-coupled VSWR < 2.5:1

Max. Voltage w/o Damage: 7Vrms, PIN diode protected
 Connector: Type N female

Input C (Options 14 & 14B)

Freq. Range: 250 MHz - 15 GHz (14) 250 MHz - 20 GHz (14B)
 Prescaler Factor: 128
 Operating input voltage range:
 0.25 - 0.5 GHz -21 to +27 dBm
 0.5 - 15 GHz -27 to +27 dBm
 14 - 17 GHz -27 to +27 dBm (14B)
 17 - 20 GHz AM -21 to +27 dBm (14B)

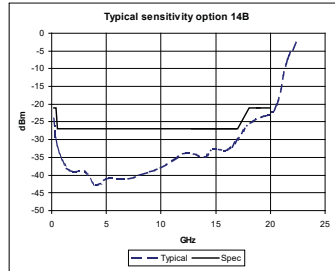

tolerance: Burst Up to 90% depth
 Minimum Burst Length: Minimum Interval Between Bursts: Period x 257
 Bursts: 10 μs
 Impedance: 50 Ω nom. AC-coupled VSWR < 2:1

Max. Voltage w/o Damage: +27 dBm, PIN diode prot.
 Connector: Type N female

Rear Panel Inputs & Outputs

Ref. Input:: 1, 5 or 10 MHz; 0.1 - 5 V_{rms} sinewave; impedance >1 kΩ
 Ref. Output: 1x10 MHz, >1 Vrms into 50 Ω load
 Arming Input (E): Arming of all meas. func.
 Freq. Range: DC - 80 MHz TTL,
 Trigger Level: 1.4 V nom. Positive or negative A, B, C (option)
 Meas. Inputs: (option)
 Impedance: 1 M Ω//50 pF or 50 Ω (VSWR ≤ 2:1)

| | |
|--------------------|---|
| Pulse Output Mode: | Pulse Out, Gate Open, Alarm Out |
| Period: | 20 ns - 2 s in 10 ns incr. |
| Pulse Width: | 10 ns - 2 s in 10 ns incr TTL |
| Output Level: | levels in 50 Ω , 2 n s rise time |
| Connectors: | BNC (SMA for Input C) |

Auxiliary Functions

Trigger Hold-Off

| | |
|-------------------|---------------------------|
| Time Delay Range: | 20 ns - 2 s, 10 ns resol. |
|-------------------|---------------------------|

External Start/Stop Arming

| | |
|----------------------------------|--|
| Modes: | Start arming, stop arming, start and stop arming |
| Input Channels: | A, B, E (EXT ARM) |
| Max. Rep. Rate for Arming Signal | |
| Channel A, B: | 160 MHz |
| Channel E: | 80 MHz |
| Start Time Delay Range: | 10 ns - 2 s, 10 ns resol. |
| Stop Time Delay* Range: | 20 ns - 2 s, 10 ns resol. |

* Stop Time Delay can only be used in conjunction with the non-manual Totalize Functions.

Statistics

| | |
|-------------------|--|
| Functions: | Maximum, minimum, mean, $\Delta_{\max-\min}$, standard deviation, Allan deviation |
| Display: | Numeric or numeric + graphic |
| Graphic: | Histogram & trend plot, auto scaled |
| Sample Size | 2 to 2×10^9 |
| Max. Sample Rate: | 250 kSa/s measured, 2 kSa/s calculated, depending on meas. function and graphics |

Limit Qualifier: Off
 Capture & store values above limit 2
 Capture & store values below limit 1
 Capture & store values inside limits 1 and 2
 Capture & store values outside limits 1 and 2

Meas. Pacing Time Range: 2 μ s - 500 s
 Equidistancy: $\pm(2 \mu$ s + 0.1% of pacing time)

Mathematics

Functions: $K \cdot X + L$, $K/X + L$, $(K \cdot X + L)/M$, $(K/X + L)/M$ and $X/M - 1$ X is current reading. K, L and M are constants, set via keyboard or as frozen reference value (X_0).

Other Functions

Measuring Time: 20 ns - 1000 s for Smart Period AVG & Smart Frequency; 20 ns - 2 s for PRF, Freq. in Burst, normal Period AVG & normal Frequency; 4 μ s - 500 s for TIE, Freq. & Period back-to-back; Single cycle for other meas. functions. Times >2 s are software controlled w. reduced resolution and accuracy

Timebase Reference: Internal, external or automatic

Display Hold: Freezes meas. result until a new measurement is initiated via Restart.

Digit Blanking: Removes (blanks) 1 to 13 digits from the calculated result before displaying it.

Limit Alarm: Annunciator on display and/or SRQ via GPIB

Limit Values: Lower limit (limit 1)
 Upper limit (limit 2)
 Off

Settings: Alarm if value > limit 2

Alarm if value < limit 1
 Alarm if limit 1 < value < limit 2
 Alarm if value > limit 2 or value < limit 1

On Alarm: Stop or Continue

Display: Numeric + graphic

Numeric: Current measurement value + annunciator for limit alarm

Graphic: Horizontal line w. upper/lower limit markers + current value marker

Stored Instrument Setups: 20 complete setups can be saved and recalled from internal non-volatile memory; 10 can be user protected.

Stored Datasets: In statistics mode w. HOLD activated, 8 datasets w. max. 32000 samples can be saved and recalled from internal non-volatile memory.

Display

Type & Use: Graphics screen for menu control, numerical readout (14 digits) and status info

Resolution: 320 x 97 pixels

Technology: Monochrome LCD with white LED backlight

GPIB Interface

Programmable Functions: All front panel accessible functions

Compatibility: IEEE 488.2-1987, SCPI 1999

Modes: Native mode
 Agilent compatible mode

Agilent Compatibility: HP 53131/132/181 commands are emulated. Code and response format is compatible. No timing compatibility. No resolution compatibility.

Interface Functions: SH1, AH1, T6, L4, SR1, RL1, DC1, DT1, E2

Max. Meas. Rate Via GPIB: 15 k readings/s (block)
 650 readings/s (individual)

| | |
|-----------------------|--|
| | 4 k readings/s (talk only) |
| To Internal Memory: | 250 k readings/s, 100 k readings/s w. calibr. on |
| Internal Memory Size: | >3.9 M readings w. calibr. off |
| Data Output: | ASCII, IEEE double precision floating point |

USB Interface

| | |
|-----------|-------------------------|
| Version: | 2.0 Full Speed, 12 Mb/s |
| Protocol: | USBTMC-USB488 |

TimeView™

This software package is intended for advanced Modulation Domain analysis and runs on any 32-bit Windows® system.

■ Data Capture Modes & Measurement Rate

Effective rate depends on measurement function and internal data format.

Free-running

| | |
|----------------------|--|
| Measurement: | 250 k readings/s |
| Repetitive Sampling: | Up to 100 Msa/s equiv. sample rate (10 ns between samples) |

| | |
|---------------------------|---|
| Continuous Single Period: | Yes, from LF to 250 kHz repetition rate |
|---------------------------|---|

Waveform

| | |
|-------------------------|--------------------------|
| Capture: | Yes |
| Data Analysis Features: | Measurement data vs time |

- Cursor measurements
- Distribution histogram
- FFT graph w. Hamming, Hanning and other relevant filters
- Smoothing
- Zoom

- Setup, measurement data archive and printing
- Zero dead time ADEV and MADEV vs. τ

Measurement Uncertainties

Random Uncertainties (1 σ)

Quantization Error (E_q)

E_q = 65 ps rms
(<50 ps rms typical)

Start/Stop Trigger Error (E_{ss})

$$E_{SS} = \sqrt{E_{noise}^2 + E_{jitter}^2} (s)$$

$$E_{noise} = \frac{\sqrt{V_{noise-input}^2 + V_{noise-signal}^2}}{inp. \text{ sign. slew rate } (V/s) \text{ at trig. point}} (s)$$

E_{jitter} = Single Period Jitter (rms) (s)

V_{noise-input}: 500 μ V_{rms} internal noise
(<200 μ V_{rms} typical)

V_{noise-signal}: The rms noise of the applied signal

Systematic Uncertainties

Trigger Level Timing Error (E_{tl})

Time Interval, Rise/Fall Time, Pulse Width, Duty Factor, Phase (*attenuator setting xl*)

$$E_{tl} = \sqrt{[TLU + \frac{1}{2} * Hyst]^2 * [(\frac{1}{Sx})^2 + (\frac{1}{Sy})^2]} [s]$$

where:

Sx = Slew rate at start trigger point (V/s) Sy = Slew rate at stop trigger point (V/s) TLU = Trigger level uncertainty (V) Hyst = Hysteresis window (V)

Hyst = 30 mV \pm 1% of trig lvl (DC to 1 kHz)
for *Pulse Width & Duty Factor*

Hyst = 6 mV \pm 1 % of trig lvl (DC to kHz) for other measurement functions.

Example for phase with sinewave signals and 0 V trigger levels (attenuator setting xl):

$$E_{tl} = [0.001/V_{pk(A)} + 0.001/V_{pk(B)}]^{\circ}, \text{ where}$$

V_{pk(A)} = Inp A peak voltage in V, and

V_{pk(B)} = Inp B peak voltage in V.

Timebase Error (TBE)

TBE is the relative error of the timebase oscillator (dimensionless) and depends on the actual oscillator used. See Timebase Options on page 8-44.

Total Uncertainty (2 σ)

The general formula for all measurement functions is:

$$U_{tot} = 2 * \sqrt{(rand. \text{ uncert.})^2 + (syst. \text{ uncert.})^2}$$

Time Interval, Pulse Width, Rise/Fall Time

Random Uncertainty (rms)

$$U_{rnd} = \sqrt{E_q^2 + (Start \text{ Trig. Error})^2 + (Stop \text{ Trig. Error})^2} [s]$$

Systematic Uncertainty

$$U_{syst} = \sqrt{\frac{1}{3} * [E_{tl}^2 + (500 \text{ ps})^2 + (TBE * TIME)^2]}$$

where:

E_{tl} = trigger level timing error

500 ps = maximum channel difference

TBE = timebase error

TIME = measurement result

Frequency & Period

■ Random Uncertainty (rms)

Smart Mode

For measuring times <200 ms and if *Smart Freq = AUTO or OFF*:

$$U_{rnd} = \frac{\sqrt{E_q^2 + 2 * (Start TriggerError)^2}}{Measuring Time} \times$$

x Measurement Result [Hz or s]

For measuring times >=200 ms and if *Smart Freq = AUTO or ON*:

$$U_{rnd} = \frac{2.5 \sqrt{E_q^2 + 2 * (Start TriggerError)^2}}{Measuring Time * \sqrt{N}} \times$$

x Measurement Result [Hz or s]

$N = 800 / Measuring Time$, however, $6 < N < 1000$ and

$N < (Freq/2) * Measuring Time - 2$ & $N < Measuring Time / 8 \mu s$

Normal Mode

$$U_{rnd} = \frac{\sqrt{E_q^2 + 2 * (Start TriggerError)^2}}{Measuring Time} \times$$

x Measurement Result [Hz or s]

■ Systematic Uncertainty

Both Modes

$$U_{syst} = \sqrt{\%_3 * \{ [TBE * MR]^2 + [(200 ps / MT) * MR]^2 \}}$$

Hz or s]

where:

MR = Meas. Result (Freq or Per)

MT = Meas. Time

Frequency Ratio f_1/f_2

■ Typical Random Uncertainty (rms)

NOTE. Frequency Ratio is an auxiliary measurement function, intended to give an indication, with no guaranteed specification.

$$U_{rnd} = 2 \times f_1 \times \sqrt{E_q^2 + E_{SS(f_1)}^2 + E_{SS(f_2)}^2}$$

[dimensionless, e.g. ppm]

Phase

■ Typical Random Uncertainty (rms)

NOTE. Phase is an auxiliary measurement function, intended to give an indication, with no guaranteed specification.

$$U_{rnd} = \sqrt{E_q^2 + (Start Trg Err)^2 + (Stop Trg Err)^2} \times Freq \times 360 [^\circ]$$

■ Systematic Uncertainty

$$U_{syst} = \sqrt{\%_3 * [E_{ii}^2 + (500 ps)^2]} \times Freq \times 360 [^\circ]$$

Duty Factor

■ Random Uncertainty (rms)

$$U_{rnd} = \sqrt{E_q^2 + (Start Trg Err)^2 + (Stop Trg Err)^2} \times Freq.$$

or minimum: 1 ppm

■ Systematic Uncertainty

$$U_{syst} = \sqrt{\%_3 * [E_{ii}^2 + (200 ps)^2]} \times Freq$$

[dimensionless, e.g. ppm]

Calibration

| | |
|--|------------------------------------|
| Mode: | Closed case, menu-controlled. |
| Calibration Input: | A |
| Password | |
| Protection: | ON or OFF |
| Input Frequencies used for TB Calibration: | 1.0, 1.544, 2.048, 5.0 or 10.0 MHz |

Definition of Terms

| | |
|-----------------------------------|---|
| Calibration Adjustment Tolerance: | The maximum tolerated deviation from the true 10 MHz frequency after calibration. If the timebase frequency does not exceed the tolerance limits at the moment of calibration, an adjustment is not necessary. |
| Total Uncertainty: | The total possible deviation from the true 10 MHz frequency under influence of frequency drift due to aging and ambient temperature variations versus the reference temperature. The operating temperature range and the calibration interval are part of this specification. |

See also timebase specifications on page 8-44.

General Specifications

Environmental Data

| | |
|--------------------|--|
| Class: | MIL-PRF-28800F, Class 3 |
| Operat. Temp: | 0 °C to +50 (+45)* °C |
| Storage Temp: | -40 °C to +71 °C, non-condensing, @ <12000 m |
| Humidity: | 5-95 % @ 10-30 °C 5-75 % @ 30-40 °C 5-45 % @ 40-50 (45)* °C 4600 m |
| Max. Altitude: | Random and sinusoidal per |
| Vibration: | MIL-PRF-28800F, Class 3 Half-sine 30G per MIL-PRF-28800F; bench handling |
| Shock: | |
| Transit Drop Test: | Transport box tested according to UN-D 1400 drop test program 1. Heavy-duty transport case and soft carrying case tested according to MIL-PRF-28800F. *CNT-91R only |
| Reliability: | MTBF 30000 h, calculated |
| Safety: | Designed and tested for Measurement Category I, Pollution Degree 2, in accordance with EN/IEC 61010-1:2001 and CAN/GSA-C22.2 No. 61010-1-04 (incl. approval) |
| EMC: | EN 61326 (1997) A1 (1998), increased test levels per EN 50082-2, Group 1, Class B, CE |

Power Requirements

| | |
|-------------------|-------------------------------|
| Line Voltage: | 100-240 Vac, 50-400 Hz (Nom.) |
| Power Consumption | |
| CNT-91: | <40 W |
| CNT-91R: | <60 W |

Dimensions & Weight

| | |
|----------|--------------------------|
| Width: | 1/2 x 19" (210 mm) |
| Height: | 2U (90 mm) |
| Depth: | 395 mm |
| Weight: | |
| CNT-91: | Net 2.7 kg (5.8 lb) |
| CNT-91R: | Shipping 3.5 kg (7.5 lb) |

Ordering Information

Basic Models

| | |
|---------------------------|---|
| CNT-91: | 400 MHz, 50 ps Timer/Counter including standard timebase and GPIB interface |
| CNT-91R: | 400 MHz, 50 ps Timer/Counter including rubidium timebase and GPIB interface |
| Included with Instrument: | 36 months product warranty, line cord, brochure with important information; 'getting started' manual, user's manual, and programmer's handbook on CD; Certificate of Calibration. |

RF Input Options

| | |
|--------------|-----------------|
| Option 10: | 3.0 GHz Input C |
| Option 13: | 8 GHz Input C |
| Option 14: | 15 GHz Input C |
| Option 14B: | 20 GHz Input C |
| Timebase Op- | |

tions

(not CNT-91R)

| | |
|-------------------------------|---|
| Option 19/90: | Medium stability OCXO Very high stability OCXO |
| Option 30/90: | high stability OCXO |
| Option 40/90: | Ultrahigh stability OCXO |
| Optional Accessories | |
| Option 11/90: | Rear panel inputs |
| Option 22/90: | Rackmount kit |
| Option 27: | Carrying case |
| Option 27H: | Heavy-duty hard transport case |
| Option 29/90: | TimeView for CNT-90/91, modulation domain analysis SW |
| Option 90/01: | Cal. certificate w. protocol; standard oscillator |
| Option 90/06: | Cal. certificate w. protocol; oven oscillator |
| Option 90/00: | Cal. certificate w. protocol; Hold-over frequency ag-ing/week |
| Option 95/05: | 5 years extended warranty |
| Printed Manuals: | Getting Started Manual |
| CNT-90 & CNT-91(R) & CNT-90XL | User's Manual |
| CNT-90 & CNT-91(R) & CNT-90XL | Programmer's Handbook |
| SW Driver on Request: | LabView |

Timebase Options CNT-91

| Product Family | '9x' | | | |
|---|--|---|--|--|
| Option Timebase Type | Standard UCXO | Option 19/90 OCXO | Option 30/90 OCXO | Option 40/90 OCXO |
| Uncertainty due to: | | | | |
| -Calibration adjustment tolerance @ +23 °C ± 3 °C | <1x10 ⁻⁸ | <5x10 ⁻⁸ | <1x10 ⁻⁸ | <3x10 ⁻⁹ |
| -Aging per 24 h per month per year | 1) <5x10 ⁻⁷ <5x10 ⁻⁶ | 2)<5x10 ⁻⁹ <6x10 ⁻⁸ <2x10 ⁻⁷ | 2)<5x10 ⁻¹⁰ <1x10 ⁻⁸ <5x10 ⁻⁸ | 2)<3x10 ⁻¹⁰ <3x10 ⁻⁹ <1.5x10 ⁻⁸ |
| -Temperature variation: 0 °C - 50 °C 20 °C - 26 °C (typ. values) | <1x10 ⁻⁶ <3x10 ⁻⁶ | <5x10 ⁻⁸ <2x10 ⁻⁸ | <5x10 ⁻⁹ <1x10 ⁻⁹ | <2.5x10 ⁻⁹ <4x10 ⁻¹⁰ |
| -Power voltage variation: ±10% | <1x10 ⁻⁹ | <5x10 ⁻⁹ | <5x10 ⁻¹⁰ | <5x10 ⁻¹⁰ |
| Short term stability: (Root Allan Variance) $\tau = 1 \text{ s}$ Typical values $\tau = 10 \text{ s}$ | not specified | <1x10 ⁻¹⁰ <1x10 ⁻¹⁰ | 1x10 ⁻¹¹ 1x10 ⁻¹¹ | 5x10 ⁻¹² 5x10 ⁻¹² |
| Power-on stability: -Deviation versus final value after 24 h on time, after a warm-up time of: | 1) 30 min | <1x10 ⁻⁷ 3U min | <1x10 ⁻⁸ 10 min | <5x10 ⁻⁹ 10 min |
| Total uncertainty, for operating temperature 0°C to 50 °C, @ 2 σ (95 %) confidence interval: -1 year after calibration -2 years after calibration | <1.2x10 ⁻⁵ <1.5x10 ⁻⁵ | 2.4x10 ⁻⁷ 4.6x10 ⁻⁷ | <6x10 ⁻⁸ <1.2x10 ⁻⁷ | <1.8x10 ⁻⁸ <3.6x10 ⁻⁸ |
| Typical total uncertainty, for operating temperature 20°C to 26 °C, @ 2 σ (95 %) confidence interval: -1 year after calibration -2 years after calibration | <7x10 ⁻⁶ <1.2x10 ⁻⁵ | <2.4x10 ⁻⁷ <4.6x10 ⁻⁷ | <6x10 ⁻⁸ <1.2x10 ⁻⁷ | <1.7x10 ⁻⁸ <3.5x10 ⁻⁸ |

Explanations

- 1) Negligible in comparison with the deviation caused by 1 °C temperature change.
- 2) After 1 month of continuous operation.

NOTE: Electrical adjustment by means of tuning voltage from DAC; no potentiometer trimming.
Serial interface to all optional oscillators for closed-case calibration and status reporting.

UCXO: Uncompensated Crystal Oscillator
OCXO: Oven Controlled Crystal Oscillator

Timebase Specifications

CNT-91R

| | |
|---|--|
| Product Family Timebase Type | '9X' Rubidium |
| Uncertainty due to: -Calibration adjustment tolerance @ +23 °C ± 3°C | <6x10 ⁻¹² |
| -Aging: per 24 h per month per year | n.a. 1) <5x10 ⁻¹¹ 2) <2x10 ⁻¹⁰ |
| -Temperature variation: 0 °C - 45 °C 20 °C - 26 °C (typ. values) | <1x10 ⁻¹⁰ <1.2x10 ⁻¹¹ |
| -Power voltage variation: ±10% | <1x10 ⁻¹¹ |
| Short term stability: (Root Allan Variance) τ = 1 s Typical values τ = 10 s | <1x10 ⁻¹¹ <3x10 ⁻¹² |
| Power-on stability: -Deviation versus final value after 24 h on time, after a warm-up time of 12 min: | <5x10 ⁻¹⁰ |
| Time to lock @25 °C | appr. 5 min |
| Total uncertainty, for operating temperature 0°C to 45 °C, @ 2 σ (95 %) confidence interval: -1 year after calibration -2 years after calibration | <3x10 ⁻¹⁰ 3) <5x10 ⁻¹⁰ |
| Typical total uncertainty, for operating temperature 20°C to 26 °C, @ 2 σ (95 %) confidence interval: -1 year after calibration -2 years after calibration | <2.5x10 ⁻¹⁰ 3) <5x10 ⁻¹⁰ |

Explanations

1) After 3 months of continuous operation.

2) After 1st year, aging during 1st year:
<5x10⁻¹⁰; long-term < 2 x 10⁻⁹ / 10 years.

3) After 1 year of operation. Uncertainty <6x10⁻¹⁰ the first year of operation.

Calibration Adjustment Tolerance is the maximum tolerated deviation from the true 10 MHz frequency after a calibration. When the reference frequency does not exceed the tolerance limits at the moment of calibration, an adjustment is not needed.

NOTE: Electrical adjustment by means of tuning voltage from DAC; no potentiometer trimming.

Serial interface for closed-case calibration and status reporting.

CNT-91R/71B

Introduction

Only values with tolerances or limits are guaranteed data. Values without tolerances are informative data, without guarantee.

Measurement Functions

Refer to page 8-40 for uncertainty information.

Inputs A and B can be swapped in all modes except **Rise Time** and **Fall Time**.

Display: All measurements are displayed with a large main parameter value and smaller auxiliary parameter values (with less resolution). Some measurements are only available as auxiliary parameters.

Frequency A, B, C

■ Range:

Input A 0.002 Hz - 400 MHz
 Input B 0.002 Hz - 400 MHz
 Input C: up to 3 GHz

Resolution: 12 digits/s (smart frequency)
 11 digits/s (normal and back-back)

■ Display:

Main Parameter: Frequency
 Aux. Parameter (A, B): V_{max} , V_{min} , V_{p-p}

Frequency Burst A, B, C

Frequency and PRF of repetitive burst signals can be measured without external control signal and with selectable start arming delay.

Functions: Frequency in burst (Hz) PRF (Hz)
 Range A, B, C: See Frequency A, B, C
 Min. Burst
 Duration: 40 ns (80 ns > 160 MHz)
 Min. No. of Pulses
 in Burst (Inp A, B): 3 (6 above 160 MHz)
 (Inp C): 3 x prescaler factor
 PRF Range (see
 also Inp C spec): 0.5 Hz - 1 MHz
 Start Delay 10 ns - 2 s, resolution
 Range: 10 ns

■ Display:

Main Parameter: Frequency in burst
 Aux. Parameters: PRF & number of cycles in burst (Ch A or Ch B only)

Period A, B, C Average

■ Range:

Input A, B: 3.3 ns - 1000 s
 Input C (3 GHz): 330 ps - 10 ns
 Resolution: 12 digits/s

■ Display:

Main Parameter: Period
 Aux Parameter (A, B): V_{max} , V_{min} , V_{p-p}

Period A, B Single

Range A, B: 3.3 ns - 1000 s
 Resolution: 50 ps rms typical

■ Display:

Main Parameter: Period
 Aux. Parameters: V max, V min,
 V p-p

Period A, B Back-to-Back

Range A, B: 4 μ s - 1000 s
 Resolution: 50 ps rms typical

■ Display:

Main Parameter: Period
 Aux. Parameters: V max, V min, V p-p

Ratio A/B, B/A, C/A, C/B

Range: 10^{-9} to 10^{11} (one-pass
 measurement, values < 1
 with reduced resolution)
 Freq Range A,B: 0.1 Hz to 400 MHz
 Freq Range C: 100 MHz to 3 GHz

■ Display:

Main Parameter: Ratio
 Aux. Parameters: Freq 1, Freq 2

Time Interval A to B, B to A, A to A, B to B

Range (normal calculation): 0 ns to $+10^6$ s
 Range (smart calculation): -10^6 to $+10^6$ s
 Resolution Single
 Shot: 50 ps rms typical
 Input Frequency: Up to 160 MHz
 Min. Pulse Width: 1.6 ns
 Smart Calculation: Smart Time Int. w. 4 time stamps (2 consecutive Trig A plus 2 consecutive Trig B)

to determine sign (A before B or A after B)

■ Display:

Main Parameter: Time interval
 Aux. Parameters: None

Pulse Width A, B

Range: 2.5 ns - 10^6 s Up to
 Input Frequency: 200 MHz Pos.
 Modes: pulse width or neg.
 pulse width

■ Display:

Main Parameter: Pulse width
 Aux. Parameters: V max, V min,
 V p-p

Rise and Fall Time A, B

Range: 1.5 ns - 10^6 s
 Input Frequency: Up to 160 MHz (square wave)
 Trigger Levels: Default 10% and 90%
 Manually adjustable
 Min. Pulse Width: 1.6 ns
 Modes: Rise or fall time
 Min. Amplitude: 100 mVp-p

■ Display:

Main Parameter: Rise or fall time
 Aux. Parameters: Slew rate, Vmax, V min

Time Interval Error (TIE) A, B

Normalized Period Back-to-Back measurements, calculated as:

$$TIE(k) = k \times T_{REF} - \sum_{i=1}^k T_i$$

T_i = individual period back-to-back and T_{REF} = reference period value.

| | |
|--------------|---|
| Range: | ±1x10 ⁷ s |
| Resolution: | 50 ps rms typical |
| Freq. Range: | 1 Hz to 250 MHz |
| Signal Type: | Clock only |
| Mode: | Auto or manual freq. set. |
| Auto Mode: | Measures freq. of the first two samples, rounded to 4 digits. |

■ Display:

Main parameter: TIE value
Aux. parameter: Clock signal frequency

Phase A Rel. B, B Rel. A

| | |
|--------------------|--|
| Range: | -180° to +360° |
| Resolution: | 0.001° to 10 kHz 0.01° to 1 MHz 0.1° to 10 MHz 1° >10 MHz |
| | Resolution can be improved by averaging (Statistics) |
| Input Frequency | Up to 160 MHz |
| Min. Pulse Width | 1.6 ns |
| Smart Calculation: | One-pass meas. of time interval + single period between two continuous signals with frequency f ₁ & f ₂ , where f ₁ /f ₂ =N or 1/N. N is an integer. The meas. is made |

with 4 time stamps, 2 consecutive trig. A + two consecutive trig. B to determine sign of phase.

■ Display:

Main Parameter: Phase
Aux. Parameters: Freq (prim. channel), VA/VB (in dB), based on peak-to-peak meas.

Duty Factor A, B

| | |
|------------------|--|
| Range: | 0.000001 to 0.999999 |
| Input Frequency | 0.1 Hz - 200 MHz |
| Min. Pulse Width | 2.5 ns |
| Smart | One-pass meas. of pulse width + single period, made with 3 time stamps, 2 consecutive pos trig A + 1 neg trig A. |
| Calculation: | |
| Modes: | Pos. or neg. duty factor |

■ Display:

Main Parameter: Duty factor
Aux. Parameters: Period, pulse width

Vmax, Vmin, Vp-p A, B

Alternative data within parentheses refer to in-put attenuator setting x10.

| | |
|--------|----------------------------------|
| Range: | -5 V to +5 V (-50 V to +50 V) |
|--------|----------------------------------|

| | |
|-------------------|--|
| Input Frequency: | DC, 1 Hz - 300 MHz, 100 Hz - 300 MHz default (higher LF limit means higher meas. speed) |
| Mode: | V _{max} , V _{min} , V _{p-p} * |
| Resolution: | 1 (10) mV |
| *Accuracy (typ.): | |
| DC | 1% ± 15 (150) mV |
| 1 Hz - 1 kHz | 1% ± 15 (150) mV |
| 1 kHz - 20 MHz | 3% ± 15 (150) mV |
| 20 - 100 MHz | 10% ± 15 (150) mV |
| 100 - 300 MHz | 30% ± 15 (150) mV |

* V_{p-p} is calculated as V_{max} - V_{min}, which means that the maximum absolute error will be ±30 (300) mV.

■ Display:

| | |
|-----------------|---|
| Main Parameter: | V _{max} or V _{min} or V _{p-p} |
| Aux Parameters: | V _{min} , V _{p-p} or V _{max} , V _{p-p} or V _{min} , V _{max} |

Totalize A, B, A+B, A-B, A/B

| | |
|---------------------|---|
| Inp. Freq. A, B: | 0 - 160 MHz |
| Inp. Freq. E (arm): | 0 - 80 MHz |
| Range A, B: | 0 to 2 ³² -1 (>4.2*10 ⁹) |
| *Main Parameters: | A, B |
| *Calc. Parameters: | A+B, A-B, A/B |
| Modes: | Manual, Gated, Start/Stop or Timed |

* If A or B is the main parameter, A-B and A/B will be displayed as aux. parameters.

If one of the calculated parameters is the main parameter, A and B will be displayed as aux. parameters.

NOTE: MANUAL controlled by front panel push button HOLD/RUN. Statistics and pacing inhibited.

GATED, START/STOP and TIMED controlled by setting arming conditions on the free input channels. Statistics and pacing allowed.

Timestamping A, B

This function is only accessible via GPIB or USB.

No absolute time exists; timestamp values can only be used for relative time measurements.

Timestamps are taken of two consecutive positive edges and two consecutive negative edges (pos, neg, pos, neg or neg, pos, neg, pos) and the number of positive edges is counted.

| | |
|------------------------------------|-----------|
| Max. Frequency: | 160 MHz |
| Min. Pulse Width: | 2.5 ns |
| Timestamp Resolution: | 35 ps rms |
| Max. Frequency to catch each edge: | 250 kHz |

Auto Set / Manual Set

All measuring functions can be auto-set using best settings for the individual functions. This means e.g. an auto hysteresis of 33% of V_{p-p} in frequency measurements, an auto trigger at 50 % of V_{p-p} with minimum hysteresis incl. hysteresis compensation in time measurements, an auto find of burst length and auto sync for frequency burst measurements, etc.
NOTE: The frequency range for inputs A & B, is up to 300 MHz for Auto trig, and up to 400 MHz for Manual trig

Input and Output Specifications

Inputs A and B

Alternative data within parentheses refer to input attenuator setting x10.

| | |
|---|--|
| Frequency Range | |
| DC-coupled: | DC - 400 MHz |
| AC-coupled: | 10 Hz - 400 MHz |
| Coupling: | AC or DC |
| Rise Time: | Approx. 700 ps |
| Impedance: | 1 M Ω /25 pF or 50 Ω (VSWR \leq 2:1) |
| Trigger Slope: | Positive or negative |
| Channels: | Separate A & B |
| Max. Channel Timing Difference: | 500 ps |
| Hysteresis Window: | Approx. 30 (300) mV _{p-p} |
| Residual Hysteresis after Compensation: | 5 (50) mV (DC - 10 kHz) |
| Sensitivity | |
| DC - 200 MHz: | 15 mV _{rms} |
| 200 - 300 MHz: | 25 mV _{rms} |
| Auto Trig: | 35 mV _{rms} |
| Attenuation: | x1, x10 |
| Dynamic Range (x1): | 30 mV _{p-p} to 10 V _{p-p} within \pm 5 V window |
| Trigger Level | Read-out on display |
| Resolution: | 1 (10) mV |
| Uncertainty: | \pm 15 (150) mV \pm 0.6% of trigger level |
| Auto trig: | Automatically set to 50% of input signal (10% and 90% for rise/fall time). Relative level (in %) manually adjustable when necessary. Minimum hysteresis window (+compensation) |
| Auto Hysteresis | |
| Time Meas. : | (+compensation) |
| Freq. Meas. & Per. Avg.: | 70 % and 30 % of input signal. Minimum hysteresis window if arming on A or B is activated. |

| | |
|--------------------------------|---|
| Freq. Range: | up to 300 MHz |
| Analog Noise Reduction Filter: | Nom. 100 kHz, RC type |
| Digital LP Filter: | 1 Hz - 50 MHz using trigger hold-off |
| Trigger Indicators: | LED |
| Max. Voltage w/o Damage | |
| 1 M Ω | 350 V (DC+ AC _{pk}) @ D C to 440 Hz, falling to 12 V _{RMS} (x1) and 120 V _{RMS} (x10) @ 1 MHz |
| 50 Ω | 12 V _{RMS} |
| Connector: | BNC |

Input C

| | |
|-------------------------------|--|
| Freq. Range: | 100 MHz - 3.0 GHz |
| Prescaler Factor: | 16 |
| Operating Input Voltage Range | |
| 100 - 300 MHz: | 20 mV _{rms} - 1.2 V _{rms} |
| 0.3-2.5 GHz: | 1.0 mV _{rms} - 1.2 V _{rms} |
| 2.5-2.7 GHz: | 20 mV _{rms} - 1.2 V _{rms} |
| 2.7-3.0 GHz: | 40 mV _{rms} -1.2 V _{rms} |
| Amplitude Modulation | |
| DC - 0.1 MHz | |
| Modulation Frequency: | Up to 94% depth |
| 0.1 - 6 MHz | |
| Modulation Frequency: | Up to 85% depth |
| | Min. signal must exceed min. oper. input voltage |
| Impedance: | 50 Ω nom. AC-coupled VSWR <2.5:1 |

Max. Voltage w/o
 Damage: 12 V_{rms} , PIN diode prot.
 Connector: Type N female

Rear Panel Inputs & Outputs

Ref. Input:: 1, 5 or 10 MHz;
 0.1 - 5 V_{rms} sinewave;
 impedance >1 k Ω Ref.
 Output: 1x100kHz, 1x1MHz,
 Outputs: 1x5MHz and 2x10 MHz
 Output level: >1 Vp-p into 50 Ω load 1
 V_{rms} typical
 Arming Input (E): Arming of all meas. func.
 Freq. Range: DC - 80 MHz
 Trigger Level: TTL, 1.4 V nom.
 Trigger Slope: Positive or negative
 Pulse Output Pulse Out, Gate Open,
 Mode: Alarm Out
 Period: 20 ns - 2 s in 10 ns incr.
 Pulse Width: 10 ns - 2 s in 10 ns incr.
 Output Level: TTL levels in 50 Ω , 2 n s
 rise time
 Connectors: BNC

Auxiliary Functions

Trigger Hold-Off

Time Delay 20 ns - 2 s, 10 ns resol.
 Range:

External Start/Stop Arming

Modes: Start arming, stop arming,
 start and stop arming

Input Channels: A, B, E (EXT ARM)

Max. Rep. Rate for

Arming Signal

Channel A, B: 160 MHz

Channel E: 80 MHz

Start Time Delay

Range: 10 ns - 2 s, 10 ns resol.

Stop Time Delay*

20 ns - 2 s, 10 ns resol.

Range:

* Stop Time Delay can only be used in
 conjunction with the non-manual
 Totalize Functions.

Statistics

Functions: Maximum, minimum, mean,
 $\Delta_{max-min}$, standard deviation,
 Allan deviation

Display: Numeric or numeric +
 graphic

Graphic: Histogram & trend plot, auto
 scaled

Sample Size: 2 to 2×10^9

Max. Sample Rate: 250 kSa/s measured, 2 kSa/s
 calculated, depending on meas.
 function and graphics

Limit Qualifier: Off
 Capture & store values above limit 2 Capture & store values below limit 1
 Capture & store values inside limits 1 and 2 Capture & store values outside limits 1 and 2

Meas. Pacing Time Range: 2 μ s - 500 s

Equidistancy: $\pm(2 \mu\text{s} + 0.1\%$ of pacing time)

Mathematics

Functions: $K \cdot X + L$, $K/X + L$, $(K \cdot X + L)/M$, $(K/X + L)/M$ and $X/M - 1$ X is current reading, K, L and M are constants, set via keyboard or as frozen reference value (X_0).

Other Functions

Measuring Time: 20 ns - 1000 s for Smart Period AVG & Smart Frequency; 20 ns - 2 s for PRF, Freq. in Burst, normal Period AVG & normal Frequency; 4 μ s - 500 s for TIE, Freq. & Period back-to-back; Single cycle for other meas. functions. Times >2 s are software controlled w. reduced resolution and accuracy.

Timebase Reference: Internal, external or automatic

Display Hold: Freezes meas. result until a new measurement is initiated via Restart.

Digit Blanking: Removes (blanks) 1 to 13 digits from the calculated result before displaying it.

Limit Alarm: Annunciator on display and/or SRQ via GPIB

Limit Values: Lower limit (limit 1)
Upper limit (limit 2)

Settings: Off

Alarm if value > limit 2
 Alarm if value < limit 1
 Alarm if limit 1 < value < limit 2
 Alarm if value > limit 2 or value < limit 1

On Alarm: Stop or Continue

Display: Numeric + graphic

Numeric: Current measurement value + annunciator for limit alarm

Graphic: Horizontal line w. upper/lower limit markers + current value marker

Stored Instrument Setups: 20 complete setups can be saved and recalled from internal non-volatile memory; 10 can be user protected.

Stored Datasets: In statistics mode w. HOLD activated, 8 datasets w. max. 32000 samples can be saved and recalled from internal non-volatile memory.

Display

Type & Use: Graphics screen for menu control, numerical readout (14 digits) and status info

Resolution: 320 x 97 pixels

Technology: Monochrome LCD with white LED backlight

GPIB Interface

Programmable Functions: All front panel accessible functions

Compatibility: IEEE 488.2-1987, SCPI 1999

Modes: Native mode
Agilent compatible mode

Agilent Compatibility: HP 53131/132/181 commands are emulated. Code and response format is compatible. No timing compatibility. No resolution compatibility.

| | |
|---------------------------|--|
| Interface Functions: | SH1, AH1, T6, L4, SR1, RL1, DC1, DT1, E2 |
| Max. Meas. Rate Via GPIB: | 15 k readings/s (block) 650 readings/s (individual) 4 k readings/s (talk only) |
| To Internal Memory: | 250 k readings/s, 100 k readings/s w. calibr. on |
| Internal Memory Size: | >3.9 M readings w. calibr. off |
| Data Output: | ASCII, IEEE double precision floating point |

USB Interface

| | |
|-----------|-------------------------|
| Version: | 2.0 Full Speed, 12 Mb/s |
| Protocol: | USBTMC-USB488 |

TimeView™

This software package is intended for advanced Modulation Domain analysis and runs on any 32-bit Windows® system.

■ Data Capture Modes & Measurement Rate

Effective rate depends on measurement function and internal data format.

| | |
|----------------|---|
| Free-running | |
| Measurement: | 250 k readings/s |
| Repetitive | Up to 100 Msa/s equiv. |
| Sampling: | sample rate (10 ns between samples) |
| Continuous | Yes, from LF to 250 kHz |
| Single Period: | repetition rate |
| Waveform | |
| Capture: | Yes |
| Data Analysis | Measurement data vs time |
| Features: | Cursor measurements Distribution histogram FFT graph w. Hamming, Hanning and other relevant filters Smoothing Zoom Setup, measurement data archive and printing Zero dead time ADEV and MADEV vs. τ |

Measurement Uncertainties

Random Uncertainties (1 σ)

■ Quantization Error (E_q)

E_q = 65 ps rms
(<50 ps rms typical)

■ Start/Stop Trigger Error (E_{SS})

$$E_{SS} = \sqrt{E_{noise}^2 + E_{jitter}^2} (s)$$

$$E_{noise} = \frac{\sqrt{V_{noise-input}^2 + V_{noise-signal}^2}}{inp. \text{ sign. slew rate } (V/s) \text{ at trig. point}} (s)$$

E_{jitter} = Single Period Jitter (rms) (s)

V_{noise-input}: 500 μ V_{rms} internal noise
(<200 μ V_{rms} typical)
V_{noise-signal}: The rms noise of the
applied signal

Systematic Uncertainties

■ Trigger Level Timing Error (E_{tl}) Time Interval, Rise/Fall Time, Pulse Width, Duty Factor, Phase (attenuator setting xl)

$$E_{tl} = \sqrt{[TLU + \frac{1}{2} * Hyst]^2 * [(\frac{1}{Sx})^2 + (\frac{1}{Sy})^2]} [s]$$

where:

S_x = Slew rate at start trigger point (V/s)
S_y = Slew rate at stop trigger point (V/s)
TLU = Trigger level uncertainty (V)
Hyst = Hysteresis window (V)

Hyst = 30 mV \pm 1% of trig lvl (DC to 1 kHz) for
Pulse Width & Duty Factor
Hyst = 6 mV \pm 1% of trig lvl (DC to 1 kHz) for
other measurement functions.

Example for phase with sinewave signals and 0
V trigger levels (attenuator setting xl):

E_{tl} = [0.001/V_{pk(A)} + 0.001/V_{pk(B)}]²; where

V_{pk(A)} = Inp A peak voltage in V, and
V_{pk(B)} = Inp B peak voltage in V.

■ Timebase Error (TBE)

TBE is the relative error of the timebase oscillator (dimensionless) and depends on the actual oscillator used. See Timebase Options on page 8-59.

Total Uncertainty (2 σ)

The general formula for all measurement functions is:

$$U_{tot} = 2 * \sqrt{(rand. \text{ uncert.})^2 + (syst. \text{ uncert.})^2}$$

Time Interval, Pulse Width, Rise/Fall Time

■ Random Uncertainty (rms)

$$U_{rnd} = \sqrt{E_g^2 + (Start \text{ Trig. Error})^2 + (Stop \text{ Trig. Error})^2} [s]$$

■ Systematic Uncertainty

$$U_{syst} = \sqrt{\frac{1}{3} * [E_{tl}^2 + (500 \text{ ps})^2 + (TBE * TIME)^2]}$$

where:

E_{tl} = trigger level timing error
500 ps = maximum channel difference
TBE = timebase error
TIME = measurement result

Frequency & Period

■ Random Uncertainty (rms)

Smart Mode

For measuring times <200 ms and if *Smart Freq = AUTO or OFF*:

$$U_{rnd} = \frac{\sqrt{E_q^2 + 2 * (Start\ Trigger\ Error)^2}}{Measuring\ Time} \times$$

x Measurement Result [Hz or s]

For measuring times >=200 ms and if *Smart Freq = AUTO or ON*:

$$U_{rnd} = \frac{2.5 \sqrt{E_q^2 + 2 * (Start\ Trigger\ Error)^2}}{Measuring\ Time * \sqrt{N}} \times$$

x Measurement Result [Hz or s]

$N = 800 / Measuring\ Time$, however, $6 < N < 1000$ and

$N < (Freq/2) * Measuring\ Time - 2$ & $N < Measuring\ Time / 8 \mu s$

Normal Mode

$$U_{rnd} = \frac{\sqrt{E_q^2 + 2 * (Start\ Trigger\ Error)^2}}{Measuring\ Time} \times$$

x Measurement Result [Hz or s]

■ Systematic Uncertainty

Both Modes

$$U_{syst} = \sqrt{\gamma_3 * \{ [TBE * MR]^2 + [(200\ ps / MT) * MR]^2 \}} [$$

Hz or s]

where:

MR = Meas. Result (Freq or Per)

MT = Meas. Time

Frequency Ratio f_1/f_2

■ Typical Random Uncertainty (rms)

NOTE. Frequency Ratio is an auxiliary measurement function, intended to give an indication, with no guaranteed specification.

$$U_{rnd} = 2 \times f_1 \times \sqrt{E_q^2 + E_{SS(f_1)}^2 + E_{SS(f_2)}^2}$$

[dimensionless, e.g. ppm]

Phase

■ Typical Random Uncertainty (rms)

NOTE. Phase is an auxiliary measurement function, intended to give an indication, with no guaranteed specification.

$$U_{rnd} = \sqrt{E_q^2 + (Strt\ Trg\ Err)^2 + (Stop\ Trg\ Err)^2} \times \\ \times Freq. \times 360 [^\circ]$$

■ Systematic Uncertainty

$$U_{syst} = \sqrt{\gamma_3 * [E_{il}^2 + (500\ ps)^2]} \times Freq \times 360 [^\circ]$$

Duty Factor

■ Random Uncertainty (rms)

$$U_{rnd} = \sqrt{E_q^2 + (Strt\ Trg\ Err)^2 + (Stop\ Trg\ Err)^2} \times Freq.$$

or minimum: 1 ppm

■ Systematic Uncertainty

$$U_{syst} = \sqrt{\gamma_3 * [E_{il}^2 + (200\ ps)^2]} \times Freq$$

[dimensionless, e.g. ppm]

Calibration

| | |
|-------------------------------|------------------------------------|
| Mode: | Closed case, menu-controlled. |
| Calibration Input: | A |
| Password Protection: | ON or OFF |
| Input Frequencies used for TB | 1.0, 1.544, 2.048, 5.0 or 10.0 MHz |
| Calibration: | |

Definition of Terms

| | |
|-----------------------------------|---|
| Calibration Adjustment Tolerance: | The maximum tolerated deviation from the true 10 MHz frequency after calibration. If the timebase frequency does not exceed the tolerance limits at the moment of calibration, an adjustment is not necessary. |
| Total Uncertainty: | The total possible deviation from the true 10 MHz frequency under influence of frequency drift due to aging and ambient temperature variations versus the reference temperature. The operating temperature range and the calibration interval are part of this specification. |

See also timebase specifications on page 8-59

General Specifications

Environmental Data

| | |
|--------------------|--|
| Class: | MIL-PRF-28800F, Class 3 |
| Operat. Temp: | 0 °C to +50 (+45)* °C |
| Storage Temp: | -40 °C to +71 °C, non-condensing, @ <12000 m |
| Humidity: | 5-95 % @ 10-30 °C 5-75 % @ 30-40 °C 5-45 % @ 40-50 (45)* °C |
| | 4600 m |
| Max. Altitude: | Random and sinusoidal per MIL-PRF-28800F, Class 3 |
| Vibration: | |
| Shock: | Half-sine 30G per MIL-PRF-28800F; bench handling |
| Transit Drop Test: | Transport box tested according to UN-D 1400 drop test program 1. Heavy-duty transport case and soft carrying case tested according to MIL-PRF-28800F. |
| Reliability: | *CNT-91R only MTBF 30000 h, calculated |
| Safety: | Designed and tested for Measurement Category I, Pollution Degree 2, in accordance with EN/IEC 61010-1:2001 and CAN/CSA-C22.2 No. 61010-1-04 (incl. approval) EN 61326 (1997) A1 (1998), increased test levels per EN 50082-2, Group 1, Class B, CE |
| EMC: | |

Power Requirements

Line Voltage: 100-240 Vac, 50-400 Hz (Nom.)
Power Consumption CNT-91: <40 W
CNT-91R: <60 W

Dimensions & Weight

Width: 1/2 x 19" (210 mm)
Height: 2U(90 mm)
Depth: 395 mm
Weight:
CNT-91: Net 2.7 kg (5.8 lb)
CNT-91R: Shipping 3.5 kg (7.5 lb)

Timebase Specifications

CNT-91R/71B

| Timebase Type | Rubidium |
|---|-------------------------|
| Uncertainty due to: | |
| -Calibration adjustment tolerance @ +23 °C ± 3°C | <6x10 ⁻¹² |
| -Aging: | |
| per 24 h | 1) <3x10 ⁻¹⁰ |
| per month | 2) <5x10 ⁻¹¹ |
| per year | 3) <3x10 ⁻¹⁰ |
| -Temperature variation: | |
| 0 °C - 50°C | <1x10 ⁻¹⁰ |
| 20 °C - 26 °C (typ. values) | <2x10 ⁻¹¹ |
| -Power voltage variation: ±10% | <1x10 ⁻¹¹ |
| Frequency retrace | |
| after 24h OFF time | |
| - after 1 h ON time | <1x10 ⁻¹⁰ |
| - after 24h ON time | <5x10 ⁻¹¹ |
| Phase noise stability: | |
| at 1kHz offset from carrier | <-140 dBc |
| Short term stability: | |
| (Root Allan Variance) | |
| τ = 1 s | <1x10 ⁻¹¹ |
| Typical values τ = 10 s | <1x10 ⁻¹¹ |
| Power-on stability: | |
| -Deviation versus final value after 24 h on time, after a warm-up time of 12 min: | <5x10 ⁻¹¹ |
| Time to lock @25 °C | appr. 5 min |
| Total uncertainty, for operating temperature 0°C to 45 °C, | |
| @2σ (95 %) confidence interval: | |
| -1 year after calibration | <3x10 ⁻¹⁰ |
| -2 years after calibration | 4) <5x10 ⁻¹⁰ |
| Typical total uncertainty, for operating temperature 20°C to 26 °C, | |
| @2σ (95 %) confidence interval: | |
| -1 year after calibration | <2.5x10 ⁻¹⁰ |
| -2 years after calibration | 4) <5x10 ⁻¹⁰ |

Explanations

- 1) After 24 hours of continuous operation, and at a quasi-constant temperature of ± 5°C within the operating range
- 2) After 3 months of continuous operation.
- 3) After 1st year, aging during 1st year:
<5x10⁻¹⁰; long-term < 2 x 10⁻⁹ / 10 years.
- 4) After 1 year of operation. Uncertainty <6x10⁻¹⁰ the first year of operation.

Calibration Adjustment Tolerance is the maximum tolerated deviation from the true 10 MHz frequency after a calibration. When the reference frequency does not exceed the tolerance limits at the moment of calibration, an adjustment is not needed.

NOTE: Electrical adjustment by means of tuning voltage from DAC; no potentiometer trimming.

Serial interface for closed-case calibration and status reporting.

This page is intentionally left blank.

Chapter 9

Index

Index

!

± 1 cycle count error 4-9

A

AC/DC coupling 3-3

Allan deviation 6-3

AM modulated signals 4-8

Aperture

 See Measuring time

Arming

 description 5-5

 examples..5-9, 5-10, 5-11, 5-12, 5-13,
 5-14

 manually..... 5-6

 stop delay..... 2-12, 5-3

 sync. delay 5-7

Attenuator

 used to reduce noise 3-7

Auto once 3-5

Auto Trig Low Freq 2-13

Auto trigger 3-8, 4-19, 6-4

 how to use..... 3-8

Averaging 4-10, 6-2

B

Battery Supply

 checking 7-13, 7-14

Burst

 Frequency (CW) 4-5

C

Carrier wave frequency AM 4-8

Carrier wave frequency FM 4-6

Channel

 See Input

Confidence limits..... 6-5

Count error, ± 1 cycle..... 4-9

Counting

 reciprocal..... 4-9

CW

 AM..... 4-8

D

DC coupling 3-3

Delay

 arming sync. 5-7

Delayed timebase 5-3

Digits Blank..... 2-17
 Display contrast adjusting..... 2-8
 Distortion..... 3-8
 Drift..... 6-4
 See Also Long time instability

Drift measurements..... 5-13
 Duty cycle
 See Duty factor

E

End of a measurement..... 5-4
 Erroneous counts..... 3-7
 Error NO TRIG..... 4-10
 Examples
 Arming 5-9, 5-10, 5-11, 5-12, 5-13, 5-14
 Ext. Arm Input
 Checking 7-10
 External gate..... 5-6

F

Filter
 analog..... 3-3
 Fixed trigger levels..... 3-5
 FM signals..... 4-6
 Free-running
 measurements..... 5-4, 5-13
 Freezing the display
 See hold/run
 Frequency..... 4-3
 back-to-back..... 4-14
 burst..... 4-4, 4-5
 modulated signals..... 4-6, 4-7
 range test 7-5

ratio 4-4

Frequency versus time
 See Profiling

Function
 period 4-13
 ratio 4-4

G

Gate
 indicator..... 5-2

H

Harmonic distortion 3-8
 Hold 5-6
 Hold-Off
 checking 7-10, 7-11
 used as filter 3-4
 Hysteresis 3-6, 4-18

I

Input C
 checking 7-12
 Input C Acquisition 2-13
 Instability..... 6-4
 Internal reference output
 checking 7-9
 Interpolator Calibration..... 2-13

J

Jitter 6-4, 6-5

L

LCD contrast
 adjusting 2-8

| | |
|-------------------------------|------------|
| Limits | 6-6 |
| LOCAL LOCKOUT mode..... | 2-8 |
| LOCAL mode | 2-8 |
| Long time instability | 6-5 |
| Low-pass filter | |
| digital..... | 3-4 |
| M | |
| Manual | |
| arming..... | 5-6 |
| Mathematics | |
| and Statistics together..... | 6-5 |
| constants..... | 6-2 |
| example | 6-2 |
| function | 6-2 |
| Mean..... | 6-3 |
| Measurement | |
| end..... | 5-4 |
| free-running..... | 5-13 |
| rate..... | 5-5 |
| start..... | 5-4 |
| timing | 5-4 |
| Measurement Errors | 4-18, 4-19 |
| Measurement rate..... | 6-4 |
| Measurement time | |
| setting | 5-2 |
| Measuring speed | 4-10, 6-4 |
| Measuring time | 5-5 |
| influence by prescaling | 4-11 |
| Misc | 2-17 |
| Modulating frequency AM | 4-9 |
| Monitoring..... | 6-2 |

N

| | |
|----------------------|------|
| No trig | |
| display message..... | 4-10 |
| Noise..... | 3-6 |

O

| | |
|-----------------|------|
| Output | 2-18 |
| Overdrive | 4-18 |

P

| | |
|------------------------------------|------------|
| Period | 4-13, 4-14 |
| single & average..... | 4-13 |
| single back-to-back | 4-14 |
| Phase..... | 4-20 |
| inaccuracies | 4-21 |
| Power Measurement | |
| CNT-90XL | 7-13 |
| Prescaling | |
| effect of | 4-11 |
| Processing a measuring result..... | 6-2 |
| Profiling | 5-9, 5-13 |
| transient | 5-14 |
| VCO step response | 5-14 |
| Pulse period | 4-13 |
| Pulse rounding..... | 4-18 |
| Pulse width | |
| description..... | 4-17 |
| R | |
| Rate of measurement | 5-5 |
| Ratio | |
| function..... | 4-4 |
| Reciprocal counting | 4-9 |
| Reference oscillators | |

| | |
|---------------------|------|
| checking..... | 7-8 |
| Restart..... | 5-2 |
| RF Inputs | |
| checking..... | 7-12 |
| Rise/Fall time..... | 4-16 |
| Rubidium oscillator | |
| checking..... | 7-8 |

S

| | |
|-------------------------------------|---------------|
| Sample-Hold..... | 4-10 |
| Sensitivity..... | 4-18 |
| checking..... | 7-5 |
| Setup time | |
| for arming..... | 5-9 |
| Single..... | 4-10 |
| Single-shot phenomena..... | 5-6 |
| Smart Frequency..... | 2-13 |
| Smart Time Interval..... | 2-13 |
| Speed | |
| arming..... | 5-9 |
| of measurement..... | 4-10 |
| Standard deviation..... | 6-3 |
| Start | |
| arming..... | 5-2, 5-6 |
| of a measurement..... | 5-4, 5-5 |
| Statistics..... | 6-3, 6-4, 6-5 |
| and Mathematics together..... | 6-5 |
| Stop | |
| arming..... | 5-2, 5-6 |
| of measurement..... | 5-5 |
| Synchronization of a measurement .. | 4-11 |
| Synchronization delay | |
| arming..... | 5-7 |
| Systematic errors | |

| | |
|----------------------------|------|
| in phase measurements..... | 4-22 |
|----------------------------|------|

T

| | |
|----------------------------------|------------|
| TIE..... | 4-16 |
| Time..... | 4-15 |
| duty factor..... | 4-17 |
| period..... | 4-13 |
| pulse width..... | 4-17 |
| rise/fall..... | 4-16 |
| time interval..... | 4-16 |
| time interval error (TIE)..... | 4-16 |
| to set up arming..... | 5-9 |
| Timeout..... | 2-13, 4-10 |
| range..... | 4-10 |
| Total Reset..... | 2-16 |
| Totalize..... | 4-24 |
| A Manual..... | 4-24 |
| A/B Manual..... | 4-25 |
| A+B Manual..... | 4-24 |
| A-B Manual..... | 4-25 |
| B Manual..... | 4-24 |
| Gated..... | 4-26 |
| in general..... | 4-24 |
| Start/Stop..... | 4-25 |
| Timed..... | 4-26 |
| Totalize & Arming..... | 4-25, 4-26 |
| Touch-hold | |
| See Sample-hold | |
| Transient profiling..... | 5-14 |
| Trigger error..... | 3-8 |
| Trigger Hold Off..... | 3-4 |
| Trigger hysteresis..... | 3-6 |
| Trigger indicators checking..... | 7-7 |
| Trigger level auto..... | 3-4 |

- converting auto to manual 3-5
- how to use..... 3-7
- manual 3-4
- setting speed..... 3-5

U

- Units 2-17

V

- VCO
 - step response profiling 5-14
- Voltage 4-27
 - checking 7-6, 7-8
 - function 4-27

X

- X max 6-3
- X min 6-3
- X p-p 6-3

Chapter 10

Service

Sales and Service Office

For additional product information, customer support and service, please contact
Pendulum Instruments at the following addresses:

Pendulum Instruments Sp. z.o.o.

ul.Lotnicza 37
80-297 Banino
Poland

Office Address:

As above

Shipping Address:

As above

phone:+48 (58) 681 89 01

fax: +48 (58) 684 86 49

Internet:

www.pendulum-instruments.com

service@pendulum-instruments.com

Chapter 11

Appendix

New Look

A new front panel design will be introduced gradually starting with the model CNT-91R. It will eventually be applied to all models in the '9X' series of counters.

The fundamental layout is unchanged, so the instructions given in the main manual are still valid. The new look can be seen below.

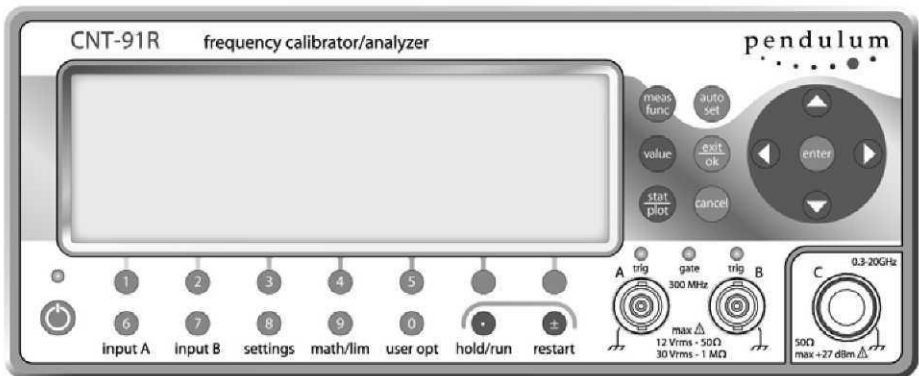

The CNT-91R front panel.